

# **South Carolina Weatherization Field Guide SWS-Aligned Edition**

**Primary author: John Krigger**

**Illustrators: John Krigger, Bob Starkey,  
Steve Hogan, Wayne Harney, Darrel Tenter**

**Technical publisher: Darrel Tenter**

**Editors: Darrel Tenter and Mary Coster**

***The South Carolina 2021 Weatherization Field Guide* presents procedures to analyze and retrofit existing buildings for energy efficiency, health, safety, and durability under the Department of Energy's Weatherization Assistance Program. This field guide is hyperlinked to DOE's Standard Work Specifications for Single-family, Multifamily, and Manufactured Homes.**

The author, project manager, and reviewers recognize the knowledge, ingenuity, and creativity of the weatherization network throughout the United States for pioneering, revising, and perfecting the standards, specifications, and procedures documented in this field guide.

## **State Reviewers**

**W. Jude McCaffrey, Damian Proctor, Matthew Melton**

**Copyright 2021 by**

**Saturn Resource Management, Inc.**

**Version 091521**

# Acknowledgments

We are Saturn Resource Management of Helena Montana. Our content expertise is energy conservation for buildings. We publish documents, create curricula, implement training, and consult.

We thank the Department of Energy's Weatherization Assistance Program (WAP) for promoting residential energy efficiency for more than 40 years and for contributing to this guide. Without the DOE, our industry wouldn't exist as a building-science-based endeavor.

DOE staff, weatherization agencies, State WAP grantees, private contractors, national laboratories, utility companies, and non-profit corporations have also contributed much to the content in this guide.

WAP installers, energy auditors, quality-control inspectors, and trainers are our most important contributors. Saturn's present and past staff have done an excellent job of compiling the information in this field guide.

For many years, we've tried to list the people who influenced Saturn's field guides in a substantial way. Now there are just too many contributors to list. You know who you are: Thank you!

Thanks to everyone who has reviewed this field guide and labored to improve it. Thank you, past-and-present customers, for allowing Saturn the privilege of serving you.

We appreciate your business.

# Preface

This Weatherization Field Guide outlines a set of best practices for the Weatherization Assistance Program (WAP). Weatherization experts collaborating with the National Renewable Energy Lab (NREL) developed the Standard Work Specifications (SWS) beginning in 2009. These new SWS standards reside online in [NREL's SWS Tool](#).

The SWS presents required specifications and outcomes for weatherization measures when a weatherization agency selects a weatherization measure, based on its cost effectiveness. The technical content of this guide aligns with the SWS requirements as updated by November of 2020.

A major purpose of this guide is to show how its contents are aligned with the SWS. Therefore, we've inserted hypertext references to the specific SWS details that aligns to our content. When you click on one of these references, the relevant detail appears in your browser.

This guide also incorporates information from a variety of other standards and specifications including these.

- DOE Weatherization Job Task Analysis
- Building Performance Institute's (BPI's) relevant standards
- International Residential Code
- Standards for combustion systems by The National Fire Protection Association (NFPA) editions, including NFPA 54, 31, and 211

We begin this guide with health and safety, an important topic for both workers and clients. The first part of the chapter discusses client health and safety. The last part of the chapter covers worker health and safety.

Next, the guide presents a chapter on energy auditing, inspecting, work-orders, and client relations. The following chapter discusses insulation and air sealing materials and their

characteristics. Next we present four chapters on the four distinct parts of the building envelope: attics and roofs; walls; floors and foundations; and windows and doors. Much of the content for these chapters is relevant to multifamily buildings as well as single-family buildings.

The guide's largest chapter is heating and cooling. This chapter contains a lot of information that is as relevant for multifamily buildings as for single-family buildings.

We created a separate chapter on ventilation that follows heating and cooling, which includes whole-house ventilation, local ventilation, attic and crawl-space ventilation, and ventilation for cooling.

We've included a dedicated chapter on manufactured (mobile) homes where we discuss the energy-conservation measures (ECMs) particular to mobile homes. In this chapter, we often reference other sections of the guide that contain information that's relevant to both mobile homes and site-built homes.

The last chapter's topic, *Air Leakage Diagnosis*, is a tool for weatherization agencies to guide cost-effective air sealing. This chapter doesn't align to the SWS because the SWS doesn't specify testing procedures.

Like the SWS, this field guide is a living document and a work-in-progress. The field guide changes as the SWS changes. We hope you find this guide authoritative, easy to use, and well aligned to the SWS. We welcome all comments, suggestions, and criticism.

Thanks for your hard work and dedication in implementing the Weatherization Assistance Program.

John Krigger  
jkrigger@srmi.biz

# **TABLE OF CONTENTS**

## **1: Health and Safety**

Educate Occupants and Building Operators .....	22
Fire Safety .....	23
Carbon Monoxide (CO) .....	24
Causes of Carbon Monoxide (CO) .....	25
Smoke and Carbon Monoxide (CO) Alarms .....	27
Occupant Education about Alarms .....	28
Smoke Alarms .....	28
CO Alarms .....	29
Gas Range-and-Oven Safety .....	30
Reducing Moisture Problems .....	33
Moisture Sources and Effects .....	33
Moisture Reduction Priorities .....	34
Symptoms of Moisture Problems .....	35
Solutions for Moisture Problems .....	36
Ground-Water Drainage .....	39
Drying Buildings with Dehumidifiers .....	42
Ground-Moisture Barriers .....	44
Pollutant Source Control .....	46
Radon .....	46
Asbestos Containing Materials (ACM) .....	47
Lead-Safe Procedures .....	50
Electrical Safety .....	53
Decommissioning Knob-and-Tube Wiring .....	55
Constructing Shielding for Knob-and-Tube Wiring .....	56
Worker Health and Safety .....	57
Commitment to Safety .....	57
New Workers .....	59
Driving .....	60
Lifting and Back Injuries .....	61

Respiratory Health.....	62
Hazardous Materials.....	63
Equipment for Personal and Crew Safety.....	64
Falls.....	65
Tool Safety.....	67
Repetitive Stress Injuries.....	68
Safety for Crawl Spaces and Other Confined Areas.....	69
Safety in Extreme Weather.....	70
SWS Alignment.....	71

## **2: Energy Audits and Quality Control Inspections**

Purposes of an Energy Audit.....	76
Energy-Auditing Judgment and Ethics.....	76
Health and Safety Considerations.....	77
Energy-Auditing Record-keeping.....	78
Client Relations.....	79
Communication Best Practices.....	79
Client Interview.....	79
Deferral of Weatherization Services.....	80
Parts of an Energy Audit.....	81
Visual Inspection.....	82
Diagnostic Testing.....	82
Quantitative Analysis: Software & Priority Lists.....	83
Work Orders.....	84
Quality Control Inspections.....	85
In-Progress Inspections.....	86
Subgrantee Final Inspections.....	86
Grantee (State) Monitoring of Subgrantees.....	88
DOE Monitoring of Grantees (States).....	89
Understanding Energy Usage.....	90
Baseload Versus Seasonal Use.....	90
Energy Indexes.....	93

Client Education..... 94

**3: Weatherization Materials**

Air-Sealing Goals ..... 95

Air Sealing Safety..... 96

    Air Sealing and Fire Containment ..... 97

Air Sealing Materials ..... 98

    Material and Sealant Specs ..... 98

    Air-Barrier Materials ..... 99

    Stuffing Materials..... 100

    Caulking and Adhesives ..... 101

    Liquid Foam Air Sealant ..... 103

Insulation Building Science ..... 105

    Insulation Receipt or Certificate ..... 106

Insulation Material Characteristics..... 107

    Fibrous Insulation Materials..... 107

Insulation Blowers and Hoses ..... 111

    Inexpensive Blowers..... 111

    Professional Blowers..... 111

    Main Parts of Insulation Blowers ..... 112

    Operating the Insulation Blowing Machines ..... 114

    Foam Board Insulation..... 115

Insulation Safety and Durability ..... 118

    Insulation Durability..... 118

Shading Materials and Methods..... 120

SWS Alignment..... 121

**4: Attics and Roofs**

Air-Sealing Attics and Roofs ..... 123

    Sealing Vertical Chases and Chimneys..... 123

    Air Sealing Recessed Lights ..... 126

    Sealing Stairways and Access Doors..... 129

Sealing Porch Roof Structures.....	130
Removing Insulation for Attic Air Sealing.....	131
Sealing Joist Cavities Under Knee Walls .....	132
Sealing Kitchen or Bathroom Interior Soffits .....	133
Sealing Two-Level Attics.....	134
Sealing Dropped Ceilings.....	134
Insulating Attics and Roofs.....	137
Preparing for Attic Insulation .....	139
Safety Preparations for Attic Insulation .....	141
Blowing Attic Insulation .....	145
Closed-Cavity Attic Floors.....	146
Insulating Closed Roof Cavities .....	147
Exterior Rooftop Foam Insulation .....	151
Installing Fiberglass Batts in Attics .....	152
Roof Deck Underside /Cathedralized Attics.....	153
Vaulted Attics .....	154
Finished Knee-Wall Attics .....	155
Knee-Wall Insulation.....	159
Access Doors in Vertical Walls.....	161
Walk-Up Stairways and Doors.....	162
Insulating & Sealing Pull-Down Attic Stairways .....	163
Parapet Walls.....	164
Skylights .....	164
Cool Roofs .....	165
Landscaping .....	166
SWS Alignment.....	169

## 5: Walls

Air Sealing Walls.....	173
Multifamily Firewalls.....	173
Built-In Cabinets/Shelves .....	174
Wall Framing Around Fireplaces and Chimneys.....	175
Pocket Door Cavities .....	176
Cooling Appliances Installed through Walls or Windows ..	



177	
Balloon Framed Walls.....	177
Air-Sealing Small Openings .....	179
Window and Door Frames .....	180
Rim Joist Area .....	180
Masonry Surfaces.....	180
Interior Wall Top Plates .....	181
Wall Insulation .....	182
Wall Insulation: Preparation and Follow-up.....	182
Retrofit Closed-Cavity Wall Insulation .....	185
Accessing Wall Cavities .....	185
Blowing Walls with a Fill-Tube .....	193
Open-Cavity Wall Insulation .....	197
Insulated Wall Sheathing .....	201
Wall Insulation in a Retrofitted Frame Wall .....	203
Insulating Unreinforced Brick Walls .....	204
SWS Alignment.....	205

## 6: Floors and Foundations

Thermal-Boundary Decisions: Floor or Foundation.....	207
Air Sealing Foundations and Floors.....	210
Garages Underneath Living Areas.....	211
Plumbing Penetrations .....	211
Stairways to Unconditioned Areas .....	212
Incomplete Finished Basements .....	215
Cantilevered Floors.....	216
Preparing for Foundation or Floor Insulation .....	217
Rim-Joist Insulation and Air-Sealing.....	217
Installing Floor Insulation .....	218
Blowing Floor Insulation .....	219
Installing Fiberglass Batt Floor Insulation.....	221
Rigid Foam Floor Insulation.....	223

Foundation Wall Insulation .....	224
Crawl-Space Wall Insulation .....	226
Basement Wall Insulation .....	227
SWS Alignment.....	231

## **7: Windows and Doors**

Storm Windows .....	235
Exterior Aluminum Storm Windows .....	235
Interior Storm Windows .....	237
Window Repair and Air Leakage Reduction.....	238
Double-Hung Window Weatherization .....	239
Weatherstripping Double-Hung Windows.....	240
Window Replacement Specifications.....	242
Window Energy Specifications .....	243
Removing Old Windows .....	244
Installing Replacement Windows .....	244
Replacing Nailing-Fin Windows .....	245
Block-Frame or Finless Windows .....	248
Flush-Fin Window Replacement .....	250
Window Safety Specifications.....	251
Windows Requiring Safety Glass .....	251
Fire Egress Windows.....	253
Window Shading Treatments .....	254
Solar Screens.....	255
Solar Window Films .....	255
Door Repair and Weatherstrip.....	256
Evaluating Exterior Doors .....	256
Causes of Door Binding.....	257
Adjusting Door Stops and Latches .....	260
Weatherstripping Doors .....	263
Door Replacement .....	264
Replacement-Door Standards.....	265
Replacement-Door Installation.....	266

SWS Alignment..... 267

## **8: Heating and Cooling Systems**

HVAC-System Commissioning & Education..... 271  
    HVAC-System Commissioning ..... 271  
    HVAC-System Education..... 272

Combustion-Safety Evaluation ..... 273  
    Combustion-Safety Observations ..... 273  
    Leak-Testing Gas Piping ..... 274  
    Carbon Monoxide (CO) Testing ..... 275  
    Worst-Case CAZ Depressurization Testing ..... 276  
    Evaluating Combustion Air at Worst-Case ..... 281  
    Mitigating CAZ Depressurization and Spillage ..... 283  
    Combustion-Air-Related Solutions ..... 286  
    Zone Isolation for Natural-Draft Vented Appliances... 286

Combustion Air..... 287  
    Un-Confined-Space Combustion Air ..... 288  
    Confined-Space Combustion Air ..... 289

Electronic Combustion Analysis..... 293  
    Critical Combustion-Testing Parameters ..... 295

Heating System Replacement..... 297  
    Combustion Furnace Replacement..... 297  
    Gas-Fired Heating Installation..... 300  
    Combustion Boiler Replacement..... 303  
    Oil-Fired Heating Installation ..... 307  
    Evaluating Oil Tanks ..... 309

Combustion Space Heater Replacement..... 311  
    Space Heater Operation ..... 312  
    Unvented Space Heaters..... 312

Gas Burner Safety & Efficiency Service ..... 313  
    Combustion Efficiency Test for Furnaces ..... 313  
    Inspecting Gas Combustion Equipment ..... 314  
    Testing and Adjustment ..... 315

Oil Burner Safety and Efficiency Service.....	316
Oil Burner Testing and Adjustment.....	317
Oil Burner Inspection and Maintenance .....	320
Inspecting Furnace Heat Exchangers .....	322
Wood Stoves .....	324
Wood Stove Clearances.....	324
Stove Clearances .....	324
Wood Stove Inspection.....	325
Inspecting Venting Systems.....	328
Vent Connectors .....	328
Chimneys .....	331
Masonry Chimneys .....	331
Manufactured Chimneys.....	335
Chimney Terminations .....	336
Air Leakage through Masonry Chimneys .....	337
Special Venting Considerations for Gas.....	338
Venting Fan-Assisted Furnaces and Boilers .....	339
Venting Sealed-Combustion Furnaces and Boilers ....	341
Sidewall Power Venting .....	341
Ducted Air Distribution .....	343
Sequence of Duct Improvements .....	343
Solving Airflow Problems .....	344
Unbalanced Supply-Return Airflow Test.....	348
Evaluating Furnace Performance.....	351
Recommended Airflow for Air Handlers .....	353
Rooftop Units (Air Handlers) .....	353
Improving Forced-Air System Airflow .....	357
Air Filtration for Air Handlers.....	360
Evaluating Duct Air Leakage .....	361
Troubleshooting Duct Leakage .....	362
Measuring Duct Air Leakage with a Duct Blower.....	366
Measuring House Pressure Caused by Duct Leakage..	369
Sealing Duct Leaks .....	371
Duct Repair and Sealing Methods.....	371

Sealing Return Ducts .....	372
Sealing Supply Ducts .....	374
Materials for Duct Sealing.....	377
Duct Insulation .....	377
Hot-Water Space-Heating Distribution .....	380
Boiler Efficiency and Maintenance .....	380
Distribution System Improvements .....	381
Steam Heating and Distribution.....	385
Steam System Maintenance .....	386
Steam System Energy Conservation.....	387
Replacing Thermostats .....	390
Electric Heat.....	392
Electric Baseboard Heat.....	392
Electric Furnaces .....	393
Heat-Pump Energy Efficiency .....	394
Evaluating Heat Pumps During the Heating Season...	395
Room or Unitary Heat Pumps .....	398
Ductless Minisplit Heat Pumps.....	400
Evaluating Ducted Central Air-Conditioning Systems ...	401
Central Air-Conditioner Inspection.....	403
Air-Conditioner Sizing .....	406
Duct Leakage and System Airflow.....	407
Evaluating Air-Conditioner Charge.....	407
SWS Alignment.....	409

## **9: Ventilation**

Pollutant Control .....	415
Pollution-Control Checklist .....	416
ASHRAE Standard 62.2–2016 Ventilation .....	416
ASHRAE 62.2–2016 Components.....	417
Whole-Dwelling Ventilation Requirement .....	417
Local Exhaust Ventilation Requirement.....	420
Infiltration Credit .....	421

Fan and Duct Specifications . . . . .	421
Fan Specifications . . . . .	422
Intake and Exhaust Fittings . . . . .	427
Duct Sizing . . . . .	428
Duct Materials and Installation . . . . .	429
Commissioning Ventilation Systems . . . . .	431
Whole-Dwelling Ventilation Systems . . . . .	431
Exhaust Ventilation . . . . .	432
Supply Ventilation . . . . .	434
Balanced Ventilation . . . . .	436
Garage Exhaust Ventilation . . . . .	438
Multifamily Ventilation . . . . .	438
Rooftop-Unit (RTUs) Economizer Ventilation . . . . .	440
Adaptive Ventilation . . . . .	440
Air Filtration for Indoor Air Quality . . . . .	441
Installing Filters for Outdoor Air . . . . .	441
Attic Ventilation . . . . .	442
Attic Ventilation as a Solution for Moisture Problems . . . . .	442
When to Install Attic Ventilation . . . . .	443
Attic Ventilation Requirements . . . . .	443
Power Ventilators . . . . .	445
Unventilated Attics . . . . .	446
Crawl Space Ventilation . . . . .	446
Naturally Ventilated Crawl Spaces . . . . .	446
Power-Ventilated Crawl Spaces . . . . .	447
Conditioned Crawl Spaces . . . . .	447
Ventilation for Cooling . . . . .	448
Whole-House Fans . . . . .	449
Window Fans . . . . .	451
Air Circulation . . . . .	452

SWS Alignment..... 453

**10: Baseload Measures**

Refrigerator Replacement and Maintenance..... 456  
    Refrigerator Replacement ..... 456  
    Refrigerator Cleaning and Tuning ..... 457  
    Refrigerator Metering Protocol..... 458

Electronic Entertainment and Computers ..... 462

Lighting-Efficiency Improvements ..... 464  
    LEDs versus CFLs ..... 464  
    Home Lighting Retrofit Equipment..... 465  
    Reducing Fixture Wattage ..... 467  
    Light Color ..... 469  
    Daylighting ..... 469

Clothes-Washer Selection/Replacement ..... 470  
    Clothes-Washer Selection..... 470  
    Clothes-Washer Installation..... 471

Clothes Dryers..... 472  
    Clothes-Dryer Selection..... 472  
    Clothes-Dryer Installation..... 472  
    Clothes-Dryer Service and Venting ..... 473

Water-Heating Energy Savings ..... 476  
    Water-Saving Shower Heads and Faucet Aerators .... 477  
    Water Heater Blankets ..... 479  
    Measuring and Adjusting Hot Water Temperature .... 481  
    Heat Traps and Water-Heater Pipe Insulation ..... 481

Selecting Storage Water Heaters ..... 482  
    Determining a Storage Water Heater’s Insulation Level ...  
    483  
    Storage Water-Heater Selection..... 484

Alternative Water Heaters..... 485  
    Sidewall-Vented Gas Storage Water Heaters..... 485  
    On-Demand Gas Water Heaters ..... 486

Heat-Pump Water Heaters .....	486
Water-Heater Installation .....	488
Comparing Water Heaters .....	489
Safety Comparison .....	489
Reliability Comparison.....	491
Efficiency and Energy Cost Comparison .....	491
Multifamily Water Heating .....	492
Multifamily Water-Heating Choices .....	493
Multifamily Storage Tanks .....	494
Circulation Systems .....	495
SWS Alignment.....	496

## **11: Mobile Homes**

Mobile-Home Heating .....	502
Furnace Maintenance and Energy Efficiency.....	504
Furnace Replacement .....	504
Mobile-Home Cooling and Ventilation Systems.....	505
Air-Conditioning Systems.....	505
Evaporative Coolers .....	506
Mobile-Home Ventilation .....	506
Mobile-Home Air Sealing .....	507
Air-Leak Locations and Sealing.....	509
Duct-Leak Locations.....	511
Belly-Pressure Test .....	512
Mobile-Home Insulation .....	515
Insulating Mobile-Home Roof Cavities.....	515
Mobile-Home Sidewall Insulation .....	522
Mobile-Home Floor Insulation .....	527
Mobile-Home Windows and Doors .....	530
Mobile-Home Storm Windows .....	531
Replacing Mobile-Home Windows .....	532
Mobile-Home Doors.....	532



Cool Roofs for Mobile Homes .....	533
Coating the Roof .....	534
Mobile-Home Skirting .....	535
SWS Alignment.....	537

## **12: Air Leakage Diagnostics**

Shell Air-Leakage Fundamentals .....	541
Goals of Air-Leakage Testing.....	542
Single-Family Airtightness Testing .....	544
Blower-Door Principles .....	544
Preparing for a Blower-Door Test.....	547
Blower-Door Test Procedures .....	548
Approximate Leakage Area .....	550
Multifamily Airtightness Testing.....	550
Testing Equipment .....	553
Multifamily Air Leakage.....	553
Multifamily Blower-Door-Test Strategies .....	554
Testing Air Barriers .....	557
Primary Versus Secondary Air Barriers .....	559
Simple Pressure Tests.....	560
Simple Zone Pressure Testing.....	562
Locating the Thermal Boundary.....	566

## **Appendices 569**

- R-values for Common Materials
- ASHRAE 62.2 Duct Sizing
- Fire Testing and Rating
- Maximum CAZ Depressurization
- Carbon Monoxide Limits
- Refrigerator Dating Chart
- BPI Combustion-Testing Diagrams

Pressure Diagnostics – Hole Size Ratios

House Depressurization Chart

**Glossary** **579**

**Index** **643**

**Video Library** **655**

# CHAPTER 1: HEALTH AND SAFETY

This chapter discusses some of the most important hazards that you find on weatherization jobs in residential buildings. The SWS contains many health-and-safety requirements that relate to various cost-effective energy-conservation measures (ECMs). We reference these SWS requirements throughout this chapter.

The chapter begins with health, safety, and durability of buildings. If health-and-safety problems affect the cost-effective ECMs you select, solve these problems before or during the weatherization work.

Workers are the most important asset of WAP. We discuss their health and safety at the end of this chapter.

## Client Health and Safety

Building fires, moisture problems, carbon-monoxide poisoning, and lead-paint poisoning are the most common and serious health and safety problems found in residential buildings.

Alert residents to any health and safety hazards that you find. Discuss known or suspected health concerns with occupants; take extra precautions based on occupant sensitivity to environmental hazards, such as chemicals and allergens.

- ✓ Inspect the building for fire hazards such as improperly installed electrical equipment, flammable materials stored near combustion appliances, or malfunctioning heating appliances. Discuss these hazards with occupants, and remove these hazards if possible, as allowed under [WPN 17-7](#).
- ✓ Understand and comply with the fire-containment code requirements of the International Residential Code (IRC) and your local Authority Having Jurisdiction (AHJ).



### **Video: Fire Resistance and Containment**

— A look at the materials, assemblies, and standards that help to keep buildings safe from fire and smoke.

- ✓ Test combustion appliances for carbon monoxide and related hazards. Also measure carbon monoxide (CO) in the ambient air. Investigate and eliminate CO.
- ✓ Find moisture problems, and discuss them with the occupant. Solve moisture problems before or during weatherization work. *See page 36.*
- ✓ Obey the EPA Repair, Renovation, and Painting rules when working on buildings constructed before 1978. Prevent dust during all weatherization projects. Explain the lead paint hazard and tell residents what you're doing to protect them. *See page 50.*



**Video: Healthy homes inspection**— An inspector performs a health inspection on a home and conducts a client interview.

## Worker Health and Safety

In the worker-safety section at the end of this chapter, we discuss the most dangerous hazards present during weatherization and how to avoid these hazards. Hazards include: driving, falls, back injuries, cuts, chemical exposure, repetitive stress, and electrical shocks. *See “Worker Health and Safety” on page 57.*

## 1.1 EDUCATE OCCUPANTS AND BUILDING OPERATORS

Homes and multifamily buildings are complex systems of building envelopes and mechanical systems that harbor a variety of

hazards. Educate occupants, landlords, and building operators about the health and safety hazards and the improvements that you make to mitigate these hazards.

- ✓ Explain any health or safety hazard you see with fellow workers, occupants, and building operators, and discuss how to mitigate the hazard.
- ✓ Suggest contacting specialists to mitigate particular hazards if appropriate.
- ✓ Explain equipment operation and maintenance (O&M).
- ✓ Provide O&M procedures manuals and manufacturers' equipment specifications. Encourage occupants or staff to store important documents in a safe and obvious location.
- ✓ Instruct occupants or staff to remove combustible materials from near ignition sources.
- ✓ Inform occupants and staff about smoke alarms, carbon monoxide (CO) alarms, and combination alarms, and explain their functioning.
- ✓ Suggest that occupants or staff remove or isolate indoor air quality hazards such as pesticides, petroleum products, and solvents.
- ✓ For complex mechanical systems in multifamily buildings, provide signs to inform occupants and building operators about operations, maintenance, and emergency procedures.

For more information on WAP policy relevant to these issues, consult [WPN 17-7](#).

## 1.2 FIRE SAFETY

The building codes focus on preventing the spread of fire within and between buildings. A fire barrier is a tested and certified wall assembly that can withstand and contain a fire for a particular time duration.

A fire partition is a fire barrier that prevents the spread of fire between the sections of a building. A firewall is a structural fire barrier between buildings that is designed to remain standing during and after a fire.

Flame spread is a tested value of how fast a material burns compared to red oak planks.

A thermal barrier is a sheeting material that protects the materials behind it from reaching a temperature of 250°F or breaching during a fire. Drywall is the most common thermal barrier and is rated for 15 minutes of protection. Fire partitions in multi-family buildings usually require a wall assembly with a 2-hour rating.

An ignition barrier is a material used with foam insulation to prevent the foam from igniting. The code specifies a number of materials that can serve as ignition barriers including drywall, plywood, fibrous insulation, galvanized steel, and intumescent paint.

*See also "Fire Testing and Rating" on page 569.*

### 1.3 CARBON MONOXIDE (CO)

#### *SWS Detail: 2.01 Safety Devices*

Carbon monoxide is a colorless, odorless, poisonous gas. The two common terms for expressing measured CO concentration are these.

1. “as measured” which compares CO molecules to air molecules in parts per million (ppm).
2. “air free”, which is a value, calculated from the as measured CO and the measured oxygen in combustion gases. Air free denotes what the CO concentration would be in an air-free sample of combustion gases.

The EPA’s suggested maximum 8-hour CO exposure is 9 ppm as measured in room air. Malfunctioning combustion appliances,

cigarette smoking, or auto exhaust are the most common CO sources. The EPA's one-hour CO limit is 35 ppm as measured.

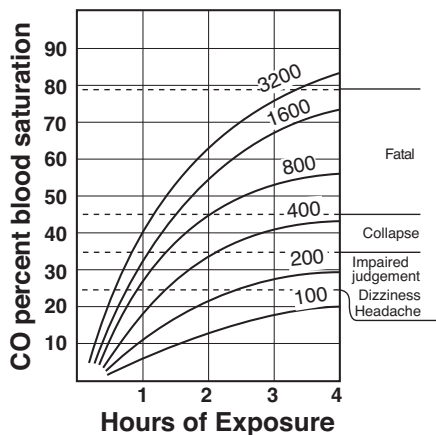

**Effects of CO:** This graph's 6 curves represent different CO exposure levels in PPM (parts per million).

### 1.3.1 Causes of Carbon Monoxide (CO)

CO is released by unvented gas space heaters, gas-fired domestic water heaters, kerosene space heaters, backdrafting vented space heaters, gas ranges, leaky wood stoves, and motor vehicles idling near the building. Central furnaces and boilers that backdraft may also lead to high levels of CO.

The following conditions cause CO.

- A combustion appliance is overfired compared to its rated fuel input.
- Backdrafting combustion gases smother the flame.
- An object interferes with the flame (a pan over a gas burner on a range top, for example).
- Too-little combustion air.
- Rapidly moving air interferes with the flame.
- Burner misalignment causes a distorted flame.

- Flue or heat exchanger blockage interferes with the flow of flue gases.

Measure CO at the exhaust port of the heat exchanger. Identify and correct CO problems.

### Testing for Carbon Monoxide (CO)

The most common CO-test instruments use electronic sensors with a digital display showing parts per million (ppm). Read the manufacturer's instructions on zeroing the meter — usually by calibrating the meter in outdoor air. CO test equipment must usually be re-calibrated every 6 months, using factory-specified procedures.

Air-free CO measurement includes both CO and O<sub>2</sub> sensing with a calculation to find the CO concentration in undiluted flue gases that contain no oxygen. Air-free CO measurement avoids the perception that moving the testing probe or diluting CO are solutions to elevated levels of CO. *“Carbon Monoxide (CO) Testing” on page 273*

Technicians must test for CO both before and after weatherization. Measure ambient CO levels outdoors and indoors. Investigate any CO levels that are higher indoors than what was measured outdoors. Use the following table for *Required Actions in Response to Ambient CO Measurements* per ANSI/BPI 1200.



**Required Actions in Response to Ambient CO Measurements**  
(from ANSI/BPI-1200, Section 7.3.3.3)

70 ppm or greater	36 ppm-69 ppm	9 ppm- 35 ppm
<ul style="list-style-type: none"> <li>• Terminate the inspection.</li> <li>• Notify the homeowner - occupant of the need for all building occupants to evacuate the building.</li> <li>• Leave the building and the appropriate emergency services shall be notified from outside the home.</li> </ul>	<ul style="list-style-type: none"> <li>• Advise the homeowner - occupant that elevated levels of ambient CO have been detected.</li> <li>• Open windows and doors. Recommend that all possible sources of CO be turned off immediately.</li> <li>• Where it appears that the source of CO is a permanently installed appliance, recommend that the appliance be turned off and advise homeowner – occupant to contact a qualified professional.</li> </ul>	<ul style="list-style-type: none"> <li>• Advise the homeowner - occupant that CO has been detected.</li> <li>• Recommend that all possible sources of CO be checked and windows and doors opened.</li> <li>• Where it appears that the source of CO is a permanently installed appliance, advise the homeowner - occupant to contact a qualified professional.</li> </ul>

## 1.4 SMOKE AND CARBON MONOXIDE (CO) ALARMS

*SWS Detail: 2.0101 Smoke Alarms; 2.0102 Carbon Monoxide (CO) Alarms*

Every dwelling should have at least one working smoke alarm. CO detectors must be installed in any dwelling unit that doesn't have a working CO detector. Install these alarms on each conditioned level, near the bedrooms or combustion devices.

Install CO alarms and smoke alarms, or combination CO/ smoke alarms, in dwellings that lack both smoke alarms and CO alarms.

Don't install alarms within 15 feet of gas ranges or combustion devices because small amounts of smoke or CO can cause nuisance false alarms.

Single-function alarms or combination alarms can interconnect electrically for whole-building protection. If one alarm sounds the other alarms sound too.

**If hard wired, a licensed electrician must install the alarms when the authority having jurisdiction (AHJ) requires hard-wired alarms.**

## 1.4.1 Occupant Education about Alarms

- ✓ Educate occupants about what to do if the alarm sounds: evacuate or at least investigate.
- ✓ Alert residents to the possibility of false alarms from smoking, cooking, dust, and forest fires.
- ✓ If battery powered, select alarms that have sealed, non-replaceable, 10-year batteries.
- ✓ Discuss the low-battery or sensor-life alarm chirping sound and how to replace the battery or alarm.
- ✓ Tell residents that alarms last less than 10 years, and that a different sound alerts them when the alarm fails.

## 1.4.2 Smoke Alarms

*SWS Detail: 2.0101.1 Hardwired (interconnected) Smoke Alarms; 2.0101.2 Battery-Operated Smoke Alarms*

Install smoke alarms labeled UL 217 in buildings where they don't exist or don't work.

- ✓ Install one smoke alarm in each dwelling on each floor.
- ✓ If mounted on a wall, mount the alarm from 4 to 12 inches from the ceiling.
- ✓ If mounted on a ceiling, mount the alarm at least 6 inches from the nearest wall.
- ✓ Recommend alarms that utilize combined photoelectric and ionization technology.
- ✓ If battery powered, select alarms that have sealed, non-replaceable, 10-year batteries.
- ✓ If hard wired, connect the alarm to a circuit that is energized at all times.

Don't install smoke alarms in these situations.

- Within 12 inches of exterior doors and windows.
- Within 20 feet of a stove or oven.
- Within 3 feet of a bathroom door.
- With an electrical connection to a switched circuit.

### 1.4.3 CO Alarms

#### *SWS Detail: 2.0102.1 CO Detection and Warning Equipment*

Install at least one CO alarm on each habitable floor of all weatherized dwellings or weatherized apartments. CO alarms must comply with these specifications.

- ✓ Have a label with a UL 2034 listing.
- ✓ If battery powered, select CO alarms that have sealed, non-replaceable, 10-year batteries.
- ✓ If hard wired, connect to a circuit that is energized at all times by plugging in to an electrical receptacle.
- ✓ Have a sensor-life alarm.

Don't install CO alarms in these situations.

- In a room that may get too hot or cold for alarm to function properly
- Within 5 feet of a combustion appliance, vent, or chimney
- Within 5 feet of a storage area for vapor-producing chemicals
- Within 12 inches of exterior doors and windows
- Within a furnace closet or room
- With an electrical connection to a switched circuit
- Less than 15 feet away from a gas range.

## 1.5 GAS RANGE-AND-OVEN SAFETY

### *SWS Detail: 6.0201.2 Kitchen Range Hoods*

Gas ovens can release CO, natural gas, or propane into a kitchen. Test the burners for safe combustion with these steps and do these recommended improvements or else hire a professional gas-service person to make the improvements.

1. Test for gas leaks in the gas piping in and around the range and oven and seal leaks.
2. Check oven for stored items. Turn the oven burner and then range burners to high one-by-one. Inspect the flames for yellow or white tips, flame impingement, wavering, or if burners are visibly dirty, corroded, or bent. For these hazards, recommend professional service.
3. Turn the oven on to a bake temperature of 500°F. Don't turn the oven to the broil setting or self-cleaning setting.
4. Measure CO in the un-diluted flue products at the oven exhaust. After 5 minutes, the CO reading for the oven must not exceed 225 ppm as-measured.
5. Measure CO for the range-top burners approximately 8 inches above the burner. At 5 minutes, the CO reading for burners must not exceed 100 PPM as-measured.



**AIR SHUTTERS**



**ORIFICE-CLEANING MULTITool**



**ORIFICE**

6. Burner orifices can clog. Clean dirty orifices with a multi-tool designed for cleaning various sizes of orifices.
7. Adjust the burner's air shutters to stabilize and harden the flame and reduce yellow-tipping, which should also reduce the CO concentration.
8. If the CO reading remains over 100 ppm as measured for range burners or 225 ppm for oven burners, consider three additional measures. 1) Install a kitchen fan if none currently exists 2) install an additional CO alarm near the kitchen but at least 20 feet away from the range 3) recommend a professional service call.

**Caution:** To protect yourself and the occupants, measure CO in the kitchen's ambient air during these tests. If the ambient CO reading is 70 ppm or more, discontinue the testing.

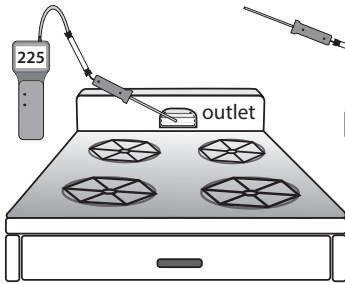

**CO from range and oven:** Measure CO at oven in undiluted flue gases. Measure ambient CO in the area of the range, but not directly above the burners or oven vent.

**Flame observation:** Unstable flames with yellow tips indicate poor combustion and possible CO production.



## Client Education about Ranges

Educate clients to follow these safety practices when using their gas range.

- ✓ Never use a range burner or gas oven as a space heater.
- ✓ Open a window, and turn on the kitchen exhaust fan when using the range or oven.
- ✓ Never install aluminum foil around a range burner or oven burner because the foil could interfere with the flame.
- ✓ Keep range burners and ovens clean to prevent dirt from interfering with combustion.
- ✓ Burners should display hard blue flames. Clients should call a service company if they notice yellow flames, white flames, wavering flames, or noisy flames.



**Video: Indoor environmental hazards—** A discussion of the riskiest environmental hazards.

## 1.6 REDUCING MOISTURE PROBLEMS

*SWS Detail: 2.0201 Drainage; 2.0202 Ground Vapor Retarders; 2.0203 Space Conditioning*

Moisture causes billions of dollars worth of respiratory distress, property damage, and high energy bills each year in American buildings. Moisture-nurtured pests, such as dust mites and mold, cause respiratory illness. Water damages building materials by nurturing destructive pests like mold and insects, dissolving glues and mortar, and corroding metal.

For more information on WAP policy relevant to moisture problems, consult [WPN 17-7](#).

### 1.6.1 Moisture Sources and Effects

Water or material wetting due to high relative humidity reduces the thermal resistance of insulation and other building materials. High humidity also increases air-conditioning costs because the air conditioner must remove airborne moisture to provide comfort.

The most common sources of moisture are leaky roofs and damp foundations. Other critical moisture sources include clothes dryers venting indoors, long showers, cooking, and unvented gas appliances like ranges or decorative fireplaces. Clients control many of these moisture sources, so educate them about how to reduce moisture sources.

Climate is also a major contributor to moisture problems. The more rain, extreme temperatures, and humid weather a region experiences, the more its buildings are vulnerable to moisture problems.

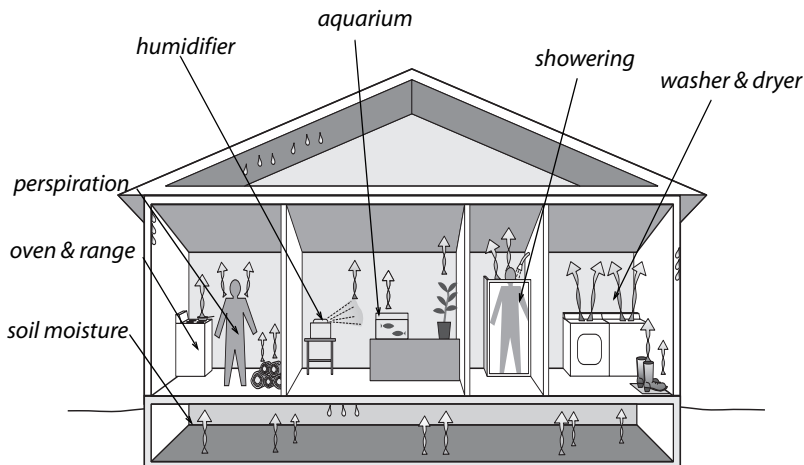

**Moisture sources:** Household moisture can often be controlled at the source by informed and motivated occupants, who work to control moisture sources like these.

## 1.6.2 Moisture Reduction Priorities

Follow these priorities by number to reduce moisture problems.

1. Reduce moisture sources such roof leaks, plumbing leaks, and standing water around the building's perimeter outdoors.
2. Install air and vapor barriers to prevent water vapor from migrating out of the soil and into building materials and building cavities.
3. Provide mechanical ventilation to remove accumulated water vapor. *See "Ventilation" on page 413.*



**Table 1-1: Moisture Sources and Their Potential Contributions**

<b>Moisture Source</b>	<b>Potential Amount Pints</b>
Ground moisture	0–105 per day
Unvented combustion space heater	0.5–20 per hour
Seasonal evaporation from materials	6–19 per day
Dryers venting indoors	4–6 per load
Dish washing	1–2 per day
Cooking (meals for four persons)	2–4 per day
Showering	0.5 per shower



**Video: Moisture movement and control**

— A discussion about health and safety problems caused by moisture.

### 1.6.3 Symptoms of Moisture Problems

*SWS Detail: 2.02 Moisture; 2.0201 Drainage; 2.0202 Ground Vapor Retarders; 2.0203 Space Conditioning*

Condensation on windows, walls, and other cool surfaces signals high relative humidity and the need to reduce moisture sources.

During very cold weather or summer air conditioning, condensation may occur on cold surfaces. Occasional condensation isn't a major problem. However, if condensation happens frequently, take action to reduce moisture sources. Adding insulation helps eliminate cold walls, ceilings, and air-conditioning ducts where water vapor condenses.

Moisture problems arise when parts of the building become wet often and remain wet. Moisture in organic or porous building

materials reaches a threshold that allows pests like mold, dust mites, and insects to thrive. These pests can cause or trigger asthma, bronchitis, and other respiratory ailments because they produce potent biological allergens.

Rot and wood decay indicate advanced moisture damage. Unlike surface mold and mildew, wood decay fungi and insects penetrate, soften, and destroy wood.



**DRY ROT**

**TERMITES**

**EFFLORESCENCE  
& SPALLING**

Peeling, blistering, or cracking paint may indicate that moisture is moving through a building material or assembly, damaging the paint and the materials underneath.

Corrosion, oxidation, and rust on metal are unmistakable signs of moisture problems. Deformed wooden surfaces may appear as the damp wood swells, and later warps and cracks as it dries.

Efflorescence is a white, powdery deposit left by water that moves through masonry and leaves minerals behind as it evaporates from the masonry surface. Masonry materials experience spalling with efflorescence that deteriorates their surfaces.

## 1.6.4 Solutions for Moisture Problems

*SWS Detail: 2.02 Moisture; 2.0201 Drainage; 2.0202 Ground Vapor Retarders; 2.0203 Space Conditioning; 3.0104.1 Closed Crawlspace Air Sealing; 6.0305 Dehumidification; 6.0305.1 Ventilator Dehumidifiers*

Preventing moisture problems is the best way to guarantee a building's durability and its occupant's respiratory health. However, the solutions get progressively more expensive if simple ones don't solve the problem.

### Inexpensive Moisture Solutions

If moisture source reduction isn't adequate to prevent moisture problems, try these solutions after preventive measures are in place.

- ✓ Repair plumbing leaks.
- ✓ Install a ground-moisture barrier. *See "Ground-Moisture Barriers" on page 44.*
- ✓ Provide crawl-space ventilation that complies with the requirements of the IRC and SWS. *See "Crawl Space Ventilation" on page 444.*
- ✓ Verify that combustion vents, clothes dryers, exhaust fans vent to the outdoors and **not** into crawl spaces or attics.
- ✓ Seal water leaks in the foundation.



**UNVENTED  
SPACE HEATER**

**WATER POOLING**

**DUCT CONDENSATION**

- ✓ Seal water leaks in the roof.
- ✓ Remove unvented space heaters, a major source of moisture, from the dwelling.
- ✓ Educate clients about ways to reduce moisture.

- ✓ Educate clients to avoid excessive watering around the building's perimeter. Watering lawns and plants close to the building can dampen its foundation. In moist climates, cut shrubbery back away from the foundation, allowing air to circulate near the foundation.
- ✓ Insulate air-conditioning ducts to prevent summer condensation.

### More Costly Moisture Solutions

Follow these preventive measures before trying any of the solutions in the next section.

- ✓ Install or improve air barriers and vapor barriers to prevent air leakage and vapor diffusion from transporting moisture into building cavities. *See page 539.*

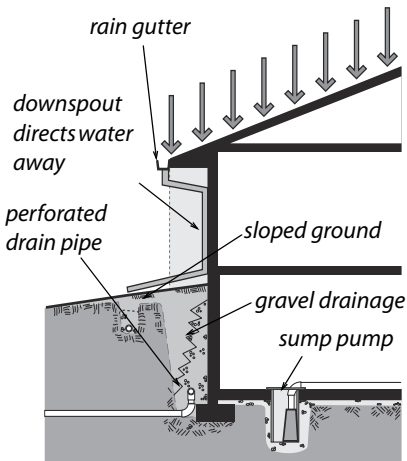

**Stopping water intrusion:**  
Take all necessary steps to protect homes from water intrusion.

- ✓ Add insulation to the walls, floor, and ceiling of a building to keep the indoor surfaces warmer and less vulnerable to winter condensation. During cold weather, well-insulated homes can tolerate higher humidity without condensation than can poorly insulated homes.
- ✓ Ventilate the dwelling with drier outdoor air to dilute the more humid indoor air. Ventilation is only effective when

the outdoor air is drier than the inside air, such as in winter. In summer, outdoor air may be more or less humid than indoor air depending on climate, time of day, and whether the dwelling is air conditioned. *See "Ventilation" on page 413.*

## 1.6.5 Ground-Water Drainage

*SWS Detail: 2.0201.1 Gutters; 2.0201.2 Downspouts; 2.0201.3 Grading; 2.0201.4 Sump Pumps*

Inadequate drainage is an important moisture problem for many buildings. Finish the following tasks before air sealing the floor or installing underfloor insulation, **as allowed under DOE guidelines or with non-DOE funds.**

Observe these specifications for gutters, downspouts, grading, and sump pumps.

### Rain Gutters

Comply with these specifications when installing or repairing rain gutters.

- ✓ Install or repair rain gutters as necessary, and verify that downspouts discharge rainwater at least 6 feet away from the building.
- ✓ Size gutters appropriately for the roof area they drain.
- ✓ Attach gutters with screws through fascia into sub-fascia or rafter tails.
- ✓ Fasten gutter sections together with mechanical fasteners, such as sheet-metal screws or pop rivets.
- ✓ Slope all gutters toward downspouts a minimum of  $\frac{1}{4}$  inch per 10 feet.
- ✓ Make all seams watertight using a compatible sealant, such as a butyl caulk. *See "Caulking and Adhesives" on page 101.*

- ✓ When replacing whole sections of rain gutters, prefer continuous rain gutters.

## Repair or Install Downspouts

Comply with these specifications when installing or repairing downspouts.

- ✓ Plan the size and number of downspouts, according to the area drained.
- ✓ Attach downspouts to gutters with mechanical fasteners, such as sheet-metal screws or pop rivets.
- ✓ Attach downspouts to dwellings a minimum of every 4 feet of their length with appropriate hardware and fasteners.
- ✓ Assemble downspout sections so that the upper section fits inside the lower section.
- ✓ Drain downspouts a minimum of 6 feet away from the structure.



Samson Gutter Hangers

**Gutter hangers:** Reinforced gutter hangers prevent snow and ice from detaching gutters from the building.



Flexible downspout termination

**Downspout terminations:** A variety of fittings like this one can drain rain water 6 feet from the building.

## Grading

### *SWS Detail: 2.0201.3 Grading*

Comply with these specifications when you can repair grading problems.

- ✓ Verify that the ground outside the building slopes away from the foundation.
- ✓ If the ground slopes toward the foundation or water puddles near the building, use topsoil, clean fill, and/or masonry materials, slope ground away from the building at least 6 inches per 10 feet.
- ✓ Clear all vegetation within 3 feet of the building or trim all vegetation to 1 foot clearance from the building.

### Install Sump Pumps, only if necessary

A sump pump is the most effective remedy when ground water continually seeps into a basement or crawl space and collects there as standing water. Persistent ground-water seepage may only be solved by connecting an interior perimeter drain to the sump.

- ✓ Suggest a sump pump for crawl spaces or basements with a history of flooding.
- ✓ Select a sump pump that meets the flow requirements of the home.
- ✓ Select the most energy efficient pump available. Prefer electrically commutated motors (ECM) when possible.
- ✓ Locate the sump pump where it collects water from the entire below-grade area and pumps it away from the foundation a minimum of 10 feet.
- ✓ The sump cover must not interfere with drainage and must be accessible and rigid.
- ✓ Install sump pumps according to the manufacturer's instructions.

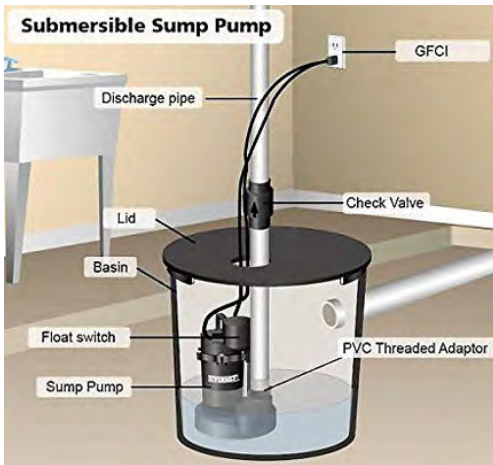

**Sump pump:** Pumps water out of a sump or basin where water collects in a basement or crawl space.

- ✓ Install a check valve to prevent pumped water from reentering the sump well.
- ✓ Verify safe operation, and ensure that floats and float switches function correctly.
- ✓ Provide resident with manufacturer's operation-and-maintenance instructions.

## 1.6.6 Drying Buildings with Dehumidifiers

*SWS Detail: 2.0203.1 Stand-Alone Dehumidifier Installation; 3.0104.1 Closed Crawlspace Air Sealing; 6.0305 Dehumidification; 6.0305.1 Ventilator Dehumidifiers*

As a last resort, remove moisture from indoor air by cooling the air to below its dew point with dehumidifiers in winter and air conditioners in summer. Using dehumidifiers and air conditioners for drying a building is the most expensive solution. Try all the moisture solutions discussed previously before resorting to a dehumidifier.

### Dehumidifier Specifications

The dehumidifier should meet these specifications.



- ✓ Must be ENERGY STAR or more efficient.
- ✓ Must have a fan-off option.
- ✓ Must retain automatic settings after power interruption.
- ✓ Must be rated for low temperature operation if located in a basement or crawl space.
- ✓ Must have features that control both peak power and energy use.

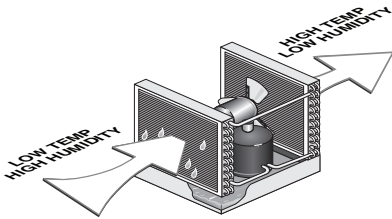

**Dehumidifiers:** In damp climates, dehumidifiers protect homes from excessive moisture.

## Dehumidifier Installation

When you install a dehumidifier, observe these requirements.

- ✓ Choose a dehumidifier with automatic controls to limit energy and power.
- ✓ Evaluate the dehumidifier for compatibility with the space where you install it. Read the specs.
- ✓ Install the dehumidifier in a location that allows free air-flow around it.
- ✓ Pipe the dehumidifier's collected water to a plumbing drain in a code-approved way.
- ✓ Seal any penetrations to the exterior of the home created by the dehumidifier's installation.
- ✓ Verify that the dehumidifier functions as designed.
- ✓ Measure the relative humidity in the space before and after completing the installation. Relative humidity should decrease after a few hours of operation.

- ✓ Verify that the dehumidifier's relative-humidity measurement is accurate, using a secondary independent measurement.
- ✓ Give the resident the user guide and warranty information, and explain how to use the dehumidifier.
- ✓ Show the occupant how to clean or change the filter and how to clean the condensate drain.
- ✓ Permanently remove old appliance from job site and recycle or dispose of removed appliance and its refrigerant to comply with local and federal law (EPA Section 608 of Clean Air Act of 1990).

## 1.6.7 Ground-Moisture Barriers

*SWS Detail: 2.0202 Ground Vapor Retarders; 2.0202.1 Un-Vented Subspaces - Ground Cover; 2.0202.2 Vented Subspaces - Ground Cover; 2.0202.3 Pier and Skirting Foundations - Ground Cover*

Air, water vapor, liquid water, and pollutants move through soil and into crawl spaces and dirt-floor basements. Even if soil's surface seems tight and dry, the soil may allow a lot of water vapor and soil gases to enter a dwelling.

Cover the ground with an airtight moisture barrier to prevent the movement of moisture and soil gases from the ground into the crawl space. Use these procedures.

### Prepare the Ground

- ✓ The crawl space should have an access hatch or door that is sized adequately for a worker or a resident to enter and exit.
- ✓ Remove biodegradable matter, such as vegetation, wood, and cardboard, from the crawl space.

- ✓ Remove all debris that can cause injury or puncture ground-moisture barrier, such as nails, wood debris, and sheet metal screws.
- ✓ Provide negative pressure in the crawl space with reference to the building when dust or vapors might migrate into the living area from the crawl space during weatherization.

### Install the Ground-Moisture Barrier

- ✓ Cover the ground completely with a ground-moisture barrier at least 6-mil polyethylene with less than 0.1 perm where little or no foot traffic exists. Install reinforced or cross-linked polyethylene where the barrier experiences foot traffic, such as when residents store belongings in the crawl space.
- ✓ Seams must overlap at least 12 inches. Seal the edges and seams with acoustical sealant, butyl caulking, or construction tape to create an airtight seal between the crawl space and the ground underneath.



**Ground-moisture barrier:**  
An airtight ground-moisture barrier blocks water vapor and gases coming up from the ground.

- ✓ The edges of the barrier should run at least 6 inches up the foundation walls and internal supporting structures. Fasten the barrier with wood strips, masonry fasteners, and sealant., such as polyurethane adhesive or acoustical sealant to a clean and flat masonry surface.

- ✓ To avoid trapping moisture against wood surfaces, ground-moisture barriers must not touch wood structural members, such as posts, mud sills, or floor joists.
- ✓ The ground vapor retarder must not interfere with the established drainage features such as sump pits or French drains.
- ✓ Fasten ground vapor retarder to ground with durable fasteners or ballasts when installed on sloping ground, or when people access the space for routine maintenance or storage.

### Post a Crawl-Space Sign

Install a durable (minimum of 10-year service life), easily seen sign, sized a minimum of 8.5" x 11" at each access to the space.

Sign must include these items.

- ✓ Warning to prohibit storage of hazardous and flammable materials.
- ✓ Caution residents not to damage the ground-moisture barrier, air barrier, insulation, or mechanical components specific to the space.
- ✓ Specify that immediate repairs are necessary in the case of damage.

## 1.7 POLLUTANT SOURCE CONTROL

Radon and asbestos are also important hazards to both occupants and workers.

For more information on WAP policy relevant to pollutant source control, consult [WPN 17-7](#).

### 1.7.1 Radon

Radon is a dangerous indoor air pollutant that comes from the ground through rocky soil. The EPA predicts about 20,000 lung

cancer deaths per year, caused by radon exposure. Weatherization workers should be aware of: the radon hazard, radon testing procedures, and radon mitigation strategies.

The EPA believes that any building with a radon concentration above 4 pico-Curies per liter (pCi/l) of air should be modified to reduce the radon concentration. Health departments and private consultants throughout the U.S. do several common and reliable tests for radon

Weatherization work usually has little effect on radon concentrations. However, ground-moisture barriers and foundation air sealing may reduce radon concentrations in addition to reducing moisture migration and air leakage.

## Radon Mitigation

DOE funds can't pay for fans or other measures specifically designed for radon mitigation. Radon mitigation must use non-DOE funds. Since radon comes through the soil, mitigation strategies include the following.

1. Install a plastic ground barrier and carefully sealing the seams and edges.
2. Seal the walls and floor of the basement or crawl space.
3. Ventilate the crawl space or basement with an exhaust fan to dilute radon.
4. Depressurize the ground underneath the basement concrete slab.

Weatherization workers may install the first two mitigation strategies as prescribed by the weatherization work order for the purpose of air sealing.

### 1.7.2 Asbestos Containing Materials (ACM)

The EPA classifies asbestos as a “known carcinogen.” The following materials may contain asbestos: boiler and steam-pipe insulation, duct insulation, floor tile, siding, roofing, some types

of vermiculite, and some adhesives. Weatherization workers must recognize asbestos and avoid disturbing it. Penalties for mishandling asbestos-containing materials can amount to \$25,000 per day.

DOE weatherization policy requires weatherization agencies to observe the following safety precautions regarding asbestos.

- Asbestos siding comes in sheets approximately 16 inches by 24 inches, and is weatherproof but brittle. Remove asbestos siding only if you can remove this siding without damaging it.
- Assume that asbestos is present in old gray-colored pipe insulation and duct insulation. Don't disturb asbestos-containing pipe or duct insulation.
- Caution occupants to avoid disturbing asbestos.
- Don't cut, drill, scrape, sand or brush ACM.
- Don't remove vermiculite. Test vermiculite for asbestos, and use air monitoring if asbestos is present in the vermiculite in a building that you're weatherizing.
- Don't do a blower-door **depressurization** test in a building where friable asbestos or vermiculite are present. Unless the suspect material has tested negative for asbestos, do a blower-door **pressurization** test instead to avoid sucking asbestos fibers into the building.

Contract with certified asbestos testers and abatement specialists to mitigate asbestos problems before or during weatherization, if necessary. Mitigate friable asbestos before doing a blower-door test.

## How to Do a Lead Test on a Painted Surface



Clean utility knife to prevent contamination.



Cut through all the layers of paint. Also install a bag beneath the cut to catch paint fragments.



First, crush the capsule and shake it to mix ingredients. Then swab the sample for 30 seconds.



Look at the swab.



Red means lead-positive and white means lead-negative.



If the surface tests negative, verify the validity of the test with the calibration card provided.

### 1.7.3 Lead-Safe Procedures

In 2010, The EPA's Lead-Safe Renovation, Repair, and Painting (RRP) rule became a legal mandate for weatherization work.

Lead dust is dangerous because it damages the neurological systems of people who ingest it. Lead often poisons children in pre-1978 homes because of paint disturbance during building improvement and because children's hand-to-mouth behavior is common. Lead poisons workers when they inhale lead dust.

Lead paint was commonly used in homes built before 1978. Contractors working on these older homes should either assume the presence of lead paint or perform tests to rule out its presence.

For information on WAP policy relevant to lead paint, consult [WPN 17-7](#).



#### **Video: Lead-Safe Weatherization Intro**

— Working with lead-based paint, and how to do it safely.

#### EPA RRP Requirements

The RRP rule requires lead-safe containment procedures whenever workers disturb painted surfaces of more than 6 square feet of interior surface per room or more than 20 square feet of exterior surface per side. Cutting, scraping, drilling, or other dust-creating activities disturb lead in pre-1978 homes. Disturbing paint on windows and doors always requires containment.

The RRP requires certifications, warnings, dust-prevention, dust collection, and housecleaning as summarized here.

- ✓ With pre-1978 homes, either test for lead-based paint or assume that lead-based paint is present. *See "How to Do a Lead Test on a Painted Surface" on page 49.*



- ✓ Every pre-1978 weatherization or renovation job that has been tested and confirmed that lead is present must be supervised by a certified renovator with 8 hours of EPA-approved training when workers disturb more than the minimum paint area or when they disturb paint on windows or doors.
- ✓ Renovation firms must be registered with the EPA and employ one or more certified renovators.
- ✓ Signs and barriers must warn occupants and passersby not to enter the work area.
- ✓ Floor-to-ceiling dust-tight barriers must prevent the spread of dust from the work area.
- ✓ Plastic sheeting must protect surfaces and fixtures within the work area.
- ✓ Workers must clean work surfaces sufficiently to pass an EPA-approved dust-wipe test, conducted by the certified renovator.
- ✓ Workers must not track dust from the work area into the dwelling.



**Video: Tenting the work area**— How to hang plastic sheeting to protect the home during weatherization work.

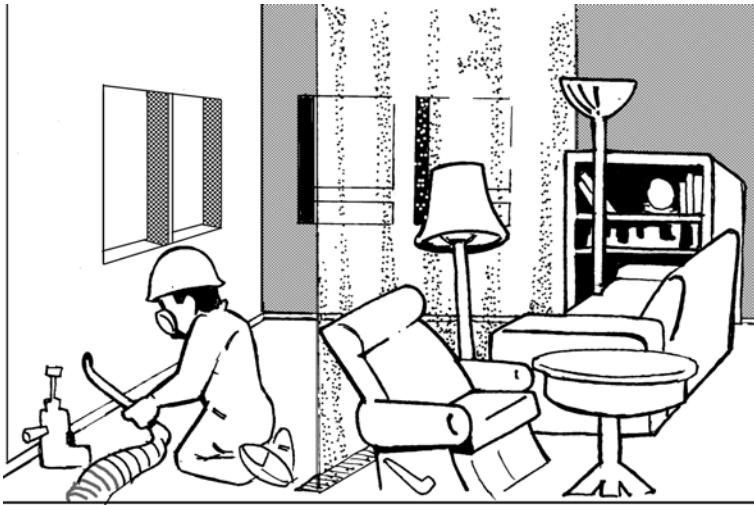

**Protective sheeting:** Dust-tight floor-to-ceiling barriers must separate work areas from living areas, according to EPA's RRP rule.

### Additional Lead-Safe Work Practices

When engaging in the paint-disturbing activities, follow these lead-safe work practices.

- ✓ Wear a tight-fitting respirator to protect yourself from breathing dust or other pollutants.
- ✓ Confine your work within the dwelling to the smallest possible floor area. Seal this area off carefully with floor-to-ceiling barriers made of disposable plastic sheeting, sealed at floor and ceiling with tape.
- ✓ Don't use heat guns or power sanders.
- ✓ Spray water on the painted surfaces to keep dust out of the air during drilling, cutting, or scraping painted surfaces.



**Drill shroud connected to HEPA vacuum:** Collect dust where you're generating it.

- ✓ Erect an effective dust-containment system outdoors to prevent dust contamination to the soil around the dwelling.
- ✓ Use a dust-containment system with a HEPA vacuum when drilling holes indoors.
- ✓ Avoid taking lead dust home on clothing, shoes, or tools. Wear boot covers while in the work area, and remove them to avoid tracking dirt from the work area to other parts of the building. Wear disposable coveralls, or vacuum cloth coveralls with a HEPA vacuum before leaving the work area.

Wash thoroughly before eating, drinking, or quitting for the day.

## 1.8 ELECTRICAL SAFETY

*SWS Detail: 2.03 Electrical; 2.0301 High Voltage (50 volts or more); 2.0301.1 Junctions/Splices Enclosed*

Electrical fires and shocks are common and serious safety problems. Electrical safety is a basic housing need, requiring attention during weatherization and repair.

Observe the following specifications for electrical safety in weatherizing existing buildings.

- ✓ When any weatherization, health, or safety procedure requires working with line-voltage power, a licensed electrician must do the procedure.
- ✓ Whenever working around wiring, use a non-contact voltage tester to determine whether circuits are live. Turn circuits off at circuit breakers as appropriate.
- ✓ Inspect wiring, fuses, and circuit breakers to verify that wiring isn't overloaded. Maximum ampacity for 14-gauge wire is 15 amps and for 12-gauge wire is 20 amps.
- ✓ Confirm that all wire splices are enclosed in electrical junction boxes. If you plan to cover a junction box with insulation, attach a flag to mark its location.
- ✓ Don't allow metal insulation shields to contact wiring.
- ✓ Verify that the electrical system is grounded to either a ground rod or to a metallic water pipe with an uninterrupted electrical connection to the ground.
- ✓ If installing insulation, install S-type fuses where appropriate to prevent occupants from installing oversized fuses.
- ✓ If installing insulation, perform a voltage-drop test to evaluate the size and condition of hidden wiring on older homes. Use a "Sure Test Branch Circuit Analyzer", or similar device that measures the voltage drop at full load (15 amps). Voltage drop may not exceed 5%.
- ✓ When you doubt the safety of a building's electrical system, use a generator to power insulation blowers and other large power tools.

For information on WAP policy relevant to electrical safety, consult [WPN 17-7](#).



**Non contact voltage tester:** Test voltage wires near your work area and take action to disconnect the circuit if appropriate.

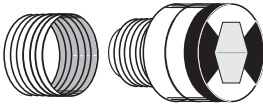

**S-type fuse:** An S-type fuse prohibits residents from oversizing the fuse and overloading an electrical circuit.

## 1.8.1 Decommissioning Knob-and-Tube Wiring

### 2.0301.2 Knob and Tube Wiring - Isolation

Decommission knob-and-tube wiring before or during weatherization if possible. Try to convince your clients or their landlords to replace knob-and-tube wiring with their own funds.

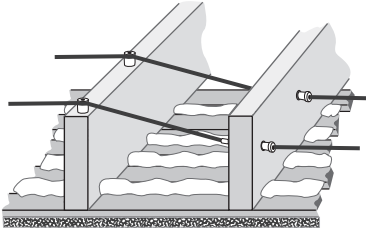

**Knob-and-tube wiring:** Replace obsolete and worn wiring during energy retrofit work so that workers can insulate building cavities sufficiently.

Use a non-contact voltage tester to determine whether the knob-and-tube wiring is live. If you're unsure about whether the wiring is still live, schedule an inspection by an electrician.

If the knob-and-tube wiring in an attic is live, ask an electrician and/or an electrical inspector to determine whether the attic wiring can be decommissioned and replaced with non-metallic (NM) sheathed electrical cable. Depending on the situation, the electrician may choose one of these two options.

1. Terminate the existing attic knob-and-tube wiring, and connect the new NM circuit directly to the main service box.
2. Install a flagged junction box in the attic to connect the knob-and-tube riser to new NM cable in the attic.

Consider installing a hard-wired CO/smoke detector in a common area near the bedrooms on the new circuit.

## 1.8.2 Constructing Shielding for Knob-and-Tube Wiring

### 2.0301.2 Knob and Tube Wiring - Isolation

You may install attic insulation up 3 inches below the bottom of knob-and-tube wiring.

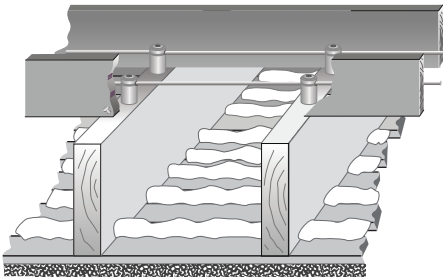

**Shielding knob and tube:** If you can't decommission knob-and-tube wiring, you may construct a dam to shield the wiring from insulation.

- ✓ Construct structural dam to maintain a 3-inch clearance between attic insulation and knob-and-tube wiring. Don't cover the knob-and-tube wiring.

## 1.9 WORKER HEALTH AND SAFETY

The personal health and safety of each worker is vitally important to every weatherization agency. Injuries are the fourth leading cause of death in the United States. Long-term exposure to toxic materials contributes to workers' sickness, absenteeism, and death. Both injury hazards and toxic substances exist during weatherization work. For information on WAP policy relevant to worker safety, consult [WPN 17-7](#).

The Occupational Safety and Health Administration (OSHA) establishes workplace safety standards. Weatherization staff and contractors must attend training on OSHA standards and observe these standards on the job. Safety always has priority over other factors affecting weatherization operations.

Some hazards deserve attention because of their statistical danger. Become aware of these most common workplace hazards.

- Vehicle accidents
- Falls
- Back injuries
- Exposure to hazardous materials
- Electrical hazards
- Repetitive stress injuries



**Video: Worker Safety Plan**— Develop a plan to avoid injuries and job related illnesses.

### 1.9.1 Commitment to Safety

Safety requires commitment, awareness, communication, and action. Workers may not remember safe work practices unless employers periodically review safe practices.

- ✓ Commit yourself to health and safety
- ✓ Develop awareness of health and safety hazards
- ✓ Communicate with coworkers about health and safety
- ✓ Take action to remove health and safety hazards from your workplace

## Safety Basics

**Safety education:** Safety meetings are an essential part of a successful safety program.



- ✓ Observe all state and federal standards relating to worker health and safety.
- ✓ Arrange regular health and safety training.
- ✓ Conduct monthly safety meetings at headquarters and weekly safety meetings on the current jobsite.
- ✓ Provide well-equipped first-aid kits in the work vehicles and in the warehouse.
- ✓ Provide and require personal protective equipment for workers appropriate for their job duties.
- ✓ Provide a fire extinguisher in the warehouse and each work vehicle.
- ✓ Keep equipment in good condition.



- ✓ Keep lists of emergency-contact phone numbers for both employees and emergency services in the warehouse and in the work vehicles.
- ✓ Keep Safety Data Sheets (SDSs) in a convenient location and tell workers where they are.

## 1.9.2 New Workers

New workers are several times more likely to injure themselves on the job compared to experienced workers. Before their first day on the job, new workers should learn about safety basics such as proper lifting, safe ladder usage, and safe operation of the power tools.



**New hire:** New hires are several times more likely to be injured than are experienced workers.

Be sure to inform new employees about hazardous materials they may encounter on the job. Show new hires the Safety Data Sheets (SDS) required by OSHA for each hazardous material they may use.

New employees should be required to use this common safety equipment.

- ✓ Proper clothing.
- ✓ Leather gloves with cuffs.
- ✓ Respirators.

- ✓ Safety glasses.
- ✓ Hearing protectors.

Ban alcohol and drugs from agency headquarters and the job. Encourage staff members to refrain from smoking and to stay physically fit.

### 1.9.3 Driving

According to the Bureau of Labor Statistics, one-third of all occupational fatalities in the United States occur in motor-vehicle accidents. Staff members should organize errands and commuting to the job site so as to minimize vehicle travel.

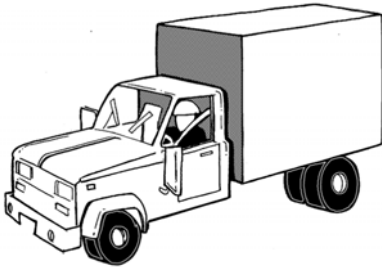

**Safe vehicles:** Maintain vehicles in good repair. Drivers and passengers should always wear seat belts.

Inspect vehicles regularly and repair them if necessary. Verify that these safety features are present and functioning.

- ✓ Brake system
- ✓ Steering system
- ✓ Horn
- ✓ Headlights
- ✓ Rear-view and side-view mirrors
- ✓ Directional signals
- ✓ Backup lights
- ✓ A fire extinguisher

Always wear seat belts. Before traveling to the job, secure tools and materials in the vehicle's cargo area to prevent shifting.

*See defensive driving by SafetyInfo.com.*

## 1.9.4 Lifting and Back Injuries

Back injuries account for one out of every five workplace injuries. Most of these injuries are to the lower back and result from improper lifting, crawling in tight spaces, and using heavy tools.

Workers often injure their backs by lifting heavy or awkward loads improperly or without help. Use proper lifting techniques such as lifting with your legs and keeping a straight back whenever possible.

To protect yourself from back injury do these things.

- ✓ Get help before trying to lift heavy or awkward loads,
- ✓ Stay in good physical condition,
- ✓ Control your weight through diet and exercise.



**Awkward loads:** Ask for help when moving heavy or awkward loads.

Workers with limited lifting abilities, because of weakness or prior injury, should avoid heavy lifting.

### Preventing Back Injury

These policies help prevent back injuries on the job.

- ✓ Redesign work activities — adapt equipment to minimize awkward movements.
- ✓ Perform strength-testing of workers, set lifting limits, and provide training for all workers on the causes and prevention of back injuries.
- ✓ Encourage breaks to prevent workers from being in straining positions for long time periods.
- ✓ Share the most difficult work among all capable crew members.

*For more information, see OSHA: Back Disorders and Injuries.*

## 1.9.5 Respiratory Health

Wear your respirator when working in a polluted environment. Common construction dust can contain toxins including lead, asbestos, and chemicals released by drilling, cutting, scraping. Liquid foam, caulking, and solvents release toxic organic vapors that require either organic vapor cartridges or a fresh-air supply.

### Fit-Test your Respirator

Test your respirators to be sure they have a good fit.

- ✓ Check the straps and face piece to be sure they are soft and free of cracks.
- ✓ Strap on the respirator and adjust the straps to be snug but comfortable.
- ✓ Close the exhalation valve with a hand.
- ✓ Exhale gently and check for leaks around the edges.
- ✓ If there are leaks, adjust or repair the respirator.

Workers with beards, facial scars, and thick temple bars on eyeglasses must use full-face respirators to achieve a good seal. OSHA requires a completed form documenting employees' fit tests each year.

For more information, see the [OSHA Respiratory Protection web pages](#).

## Special Respiratory Hazards

Consider and take action to protect yourself from these special respiratory hazards.

1. When spraying low-pressure polyurethane foam, use an organic vapor respirator cartridge with a P-100 particle filter. Also ventilate the area where you're spraying the foam.
2. When spraying high-pressure polyurethane foam, use a supplied-air, positive-pressure respirator, and ventilate the work area.
3. Learn how to recognize asbestos insulation that may be installed around older furnaces and boilers. Avoid disturbing asbestos in any way.
4. Control dust in your client's homes by erecting temporary barriers when you're doing work that may release dust.
5. Wear coveralls when entering attics or crawl spaces. Coveralls should be disposable or professionally laundered.



**Video: Respirators**— Proper use and care of fit tested respirators, along with other personal protective equipment.

### 1.9.6 Hazardous Materials

Hazardous materials threaten your health and safety on the job. Workers often fail to protect themselves from hazardous materials because they don't recognize the hazards. Breathing hazardous materials, absorbing them through the skin, and coming

into eye contact with hazardous materials are common ways dust and chemicals injure workers.

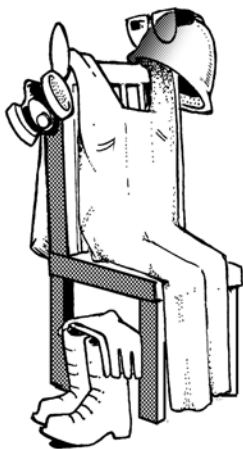

**Personal protective equipment:** Employees should own and maintain protective equipment to protect themselves from hazardous materials.

OSHA regulations require employers to notify and train employees about hazardous materials used on the job. Obtain copies of Safety Data Sheets (SDSs) from manufacturers or their distributors. Employers must make SDS for every workplace hazardous material readily available to workers.

Inspect the work site to identify hazardous materials and to plan how to avoid the hazard.

Learn how to handle hazardous materials used on the job. Use the personal protective equipment (PPE) that is recommended by the SDS.

For more information, see [OSHA's Hazard web pages](#).

### 1.9.7 Equipment for Personal and Crew Safety

Workers should have their own personal protective equipment.

- Respirators with dust and organic-vapor cannisters
- Clean cloth coveralls or disposable coveralls
- Gloves

- Safety glasses
- Hearing protection
- Hard hat for head-injury hazards

Crews should equip themselves with the safety equipment listed here.

- Ladder levelers and stabilizers
- Portable lights for work in dark areas
- A water jug
- Insect spray
- Safe, heavy electrical cords with GFCI or AFCI receptacles as required locally

### 1.9.8 Falls

Falls off ladders and stairs cause 13% of workplace injuries according to the National Safety Council. Other falls from the heights account for approximately 7% of workplace injuries.



**Ladders:** Ladders are the most dangerous tools workers use.

Broken ladders and unstable ladders are both major causes of on-the-job falls. Step ladders, for instance, are often used for

work that is too far off the ground, forcing workers to stand on the top step or to reach too far.

## Guidelines for Ladders

OSHA regulations include these important guidelines for ladder use.

- ✓ Avoid metal ladders.
- ✓ Maintain all ladders in good repair, and replace ladders if they have missing or damaged steps, cracked side-rails, or damaged feet.
- ✓ Extend extension ladders at least three feet above the area they access.
- ✓ Ladders shouldn't have a pitch steeper than four feet of rise for each foot that the ladder's feet are away from the building.
- ✓ Block or tie ladders firmly in place at the top and bottom if you install the ladder at a steeper angle than suggested above or on windy days.
- ✓ Don't use metal ladders where they may accidentally touch electrical conductors.
- ✓ Maintain ladders free of oil, grease, and other slipping hazards. Inspect your shoes for slipping hazard before climbing a ladder.
- ✓ Don't over-reach — instead move the ladder.
- ✓ Avoid carrying heavy loads up ladders and operating power tools from ladders.

## Scaffolds

Build scaffolds when working above-ground for sustained time periods. Stabilize each scaffold leg so that it supports an equal weight as other legs. Secure planks to the structure and provide handrails on the sides and ends of walkways.



## Housekeeping



**Good housekeeping:** Clear stairs and walkways are essential to protect workers and clients alike from falls.

Workers should inspect their workplaces regularly to notice and remove slipping and tripping hazards. Workers carrying loads should create and maintain debris-free walkways.

### 1.9.9 Tool Safety

The tools used in construction work are dangerous if used improperly. About 90,000 people hurt themselves with hand tools each year. The crew chief should conduct tool-safety training as frequently as necessary to insure safe tool use.

These basic safety rules can reduce the hazards of using hand and power tools.

- ✓ Use the right tool for the job.
- ✓ Keep all tools in good condition with regular maintenance.
- ✓ Inspect tools for damage before using them.
- ✓ Operate tools according to the manufacturer's instructions.
- ✓ Wear appropriate personal protective equipment.
- ✓ Use double insulated power tools or ground-fault-circuit-interrupter (GFCI) outlets or GFCI extension cords to prevent electric shock.



**Electrical safety:** Maintain cords in good condition. Use ground-fault-circuit interrupter (GFCI) cords for outlets in wet conditions.

- ✓ Use generators for electrical service on the jobsite and ground them. Exhaust gases must not enter indoor spaces or pollute the outdoor air near workers.
- ✓ Use three-wire electrical cords without worn or frayed jackets.
- ✓ Verify that generator exhaust is directed away from the building, the vehicle, and the crew.

### 1.9.10 Repetitive Stress Injuries

Repetitive stress injuries are caused by over-working certain parts of your body. Poor body posture, such as reaching above your head when operating a power drill, can encourage these injuries. Good work habits prevent this type of injury.

- ✓ Use a comfortable arm and hand posture when operating tools for a long period of time.
- ✓ Change the angle and location of your work surface frequently.
- ✓ Mix your difficult tasks with easier ones.
- ✓ Carry smaller loads.
- ✓ Take short rest breaks periodically, and stretch any tight muscles during this time.

When you purchase hand and power tools, look for models with ergonomic designs that place less stress on your body.

### 1.9.11 Safety for Crawl Spaces and Other Confined Areas

The Occupational Safety and Health Administration (OSHA) defines a confined space as a space that contains a hazard like confinement, limited access, or restricted airflow because of its small size.

#### Access to Confined Spaces

Employers must be aware of the hazards of confined spaces and have policies for protecting workers. Consider these steps when appropriate.

- ✓ Remove contaminants such as sewage, dead animals, rotting leaves, etc. before inspecting or working in the crawl space.
- ✓ The crawl space should have an access hatch or door that is sized adequately for a worker or a resident to enter and exit.
- ✓ Workers should identify access and egress points before entering a confined space.
- ✓ If a heating and cooling system is located in the crawl space, the crawl space must have an access hatch or door measuring 22 inches by 30 inches or big enough to remove the heating and cooling system, whichever is greater.

#### Chemicals in Confined Space

Observe these requirements when using chemicals in confined spaces.

- ✓ At minimum, workers using any type of chemical in a confined space must employ continuous powered ventilation

using adequately sized openings to facilitate airflow into and out of the confined space.

- ✓ If workers use chemicals in significant quantities, such as spraying of two-part polyurethane foam, the workers should wear respirators that supply fresh air.
- ✓ If a confined space contains a hazard like chemical vapors or the potential to collapse or trap a worker, the space is called a permit-required confined space (PRCS). A worker must have a permit to enter the space and workers without permits must not enter. The permitted workers must have special training and equipment to enter the confined space.

### 1.9.12 Safety in Extreme Weather

Extreme weather is a common cause of job-related sickness and injury. You can avoid sickness and injury by awareness and preventive measures.

#### Hot-Weather Safety

Know the signs of heat ailments, and take action if you or a co-worker experiences the beginning of symptoms. Observe these hot-weather suggestions for staying cool and preventing heat ailments.

- ✓ Drink plenty of water and take salt tablets.
- ✓ Ventilate attics with fans.
- ✓ Rotate workers in attics to prevent heat exhaustion.
- ✓ Use water or ice to cool your skin if you experience heat stress.
- ✓ Rest when you feel fatigued.

## Cold-Weather Safety

Workers and supervisors should know the temperature, wind speed, and precipitation forecast. Dress for extreme cold and plan work around storms and other extreme weather events.

- ✓ Dress in layers for comfort and changing temperatures.
- ✓ Wear insulated boots or heavy socks.
- ✓ Wear insulated gloves.
- ✓ Seek warm shelter if you experience numbness or uncomfortable chilling.

## Windy-Weather Safety

Be aware of the forecast for windy weather and take precautions before beginning work and before the wind blows.

- ✓ Tie ladders off high and anchor them low.
- ✓ Avoid carrying sheet goods that could act as a sail allowing the wind to blow you over.
- ✓ Store materials and tools where the wind can't move them.

## 1.10 SWS ALIGNMENT

<b>Field Guide Topic</b>	<b>SWS Detail</b>
1.3: Carbon Monoxide (CO) - Pg. 24	2.01 Safety Devices
1.4: Smoke and Carbon Monoxide (CO) Alarms - Pg. 27	2.0101 Smoke Alarms 2.0102 Carbon Monoxide (CO) Alarms
1.4.1: Occupant Education about Alarms - Pg. 28	2.0102.1 CO Detection and Warning Equipment 2.0101.1 Hardwired (interconnected) Smoke Alarms

<b>Field Guide Topic</b>	<b>SWS Detail</b>
1.4.2: Smoke Alarms - Pg. 28	2.0101.1 Hardwired (interconnected) Smoke Alarms
1.4.3: CO Alarms - Pg. 29	2.0102.1 CO Detection and Warning Equipment
1.5: Gas Range-and-Oven Safety - Pg. 30	6.0201.2 Kitchen Range Hoods
1.6: Reducing Moisture Problems - Pg. 33	2.02 Moisture 2.0201 Drainage 2.0202 Ground Vapor Retarders 2.0203 Space Conditioning
1.6.2: Moisture Reduction Priorities - Pg. 34	2.02 Moisture 2.0201 Drainage 2.0202 Ground Vapor Retarders 2.0203 Space Conditioning
1.6.4: Solutions for Moisture Problems - Pg. 36	2.02 Moisture 2.0201 Drainage; 2.0202 Ground Vapor Retarders; 2.0203 Space Conditioning 3.0104.1 Closed Crawlspace Air Sealing 6.0305 Dehumidification 6.0305.1 Ventilator Dehumidifiers
1.6.5: Ground-Water Drainage - Pg. 39	2.0201.1 Gutters 2.0201.2 Downspouts 2.0201.3 Grading 2.0201.4 Sump Pumps
1.6.6: Drying Buildings with Dehumidifiers - Pg. 42	2.0203.1 Stand-Alone Dehumidifier Installation 3.0104.1 Closed Crawlspace Air Sealing 6.0305 Dehumidification 6.0305.1 Ventilator Dehumidifiers

<b>Field Guide Topic</b>	<b>SWS Detail</b>
1.6.7: Ground-Moisture Barriers - Pg. 44	2.0202 Ground Vapor Retarders 2.0202.1 Un-Vented Subspaces - Ground Cover 2.0202.2 Vented Subspaces - Ground Cover 2.0202.3 Pier and Skirting Foundations - Ground Cover
1.8: Electrical Safety - Pg. 53	2.0301 High Voltage (50 volts or more) 2.0301.1 Junctions/Splices Enclosed
1.8.1: Decommissioning Knob-and-Tube Wiring - Pg. 55	2.0301.2 Knob and Tube Wiring - Isolation
1.8.2: Constructing Shielding for Knob-and-Tube Wiring - Pg. 56	2.0301.2 Knob and Tube Wiring - Isolation





## **CHAPTER 2: ENERGY AUDITS AND QUALITY CONTROL INSPECTIONS**

This chapter outlines the operational process of energy audits, work orders, and final inspections as practiced by non-profit agencies and contractors working in the Department of Energy's (DOE) Weatherization Assistance Program (WAP).

### WAP's Mission

The mission of DOE WAP is **“To reduce energy costs for low-income families, particularly for the elderly, people with disabilities, and children, by improving the energy efficiency of their homes while ensuring their health and safety.”**

This chapter also discusses ethics, client relations, and client education.

### Applicable DOE Policy

Comply with DOE Policy as expressed by Weatherization Program Notices (WPNs) and memorandums that DOE issues several times each program year. Also comply with the DOE's Standard Work Specifications (SWS) for each energy conservation measure that your weatherization service provider installs. This field guide links to the SWS through a data-base tool managed by the National Renewable Energy Lab (NREL). See [WPN 17-7: Weatherization Health and Safety Guidance](#).

### Why We Care about Health and Safety

The health and safety of clients must never be compromised by weatherization. Harm caused by our work would hurt our clients, ourselves, and our profession. Weatherization work can change the operation of heating and cooling systems, alter the moisture balance within the home, and reduce a home's natural

ventilation rate. Weatherization workers must take all necessary precautions to avoid harm from these changes.

## 2.1 PURPOSES OF AN ENERGY AUDIT

An energy audit evaluates a home's existing condition and outlines improvements to the energy efficiency, health, safety, and durability of the home.

Depending on the level of the audit, an energy audit may include some or all of the following tasks.

- Inspect the building and its mechanical systems to gather the information necessary for decision-making.
- Evaluate the current energy consumption along with the existing condition of the building.
- Diagnose areas of energy waste, health and safety, and durability problems related to energy conservation.
- Recommend energy conservation measures (ECMs).
- Diagnose health and safety problems, and how the proposed ECMs may affect these problems.
- Predict savings expected from ECMs.
- Estimate labor and material costs for ECMs.
- Educate residents about their energy usage and proposed energy retrofits.
- Encourage behavioral changes that reduce energy waste.
- Provide written documentation of the energy audit and the recommendations offered.

### 2.1.1 Energy-Auditing Judgment and Ethics

The auditor's good decisions are essential to the success of a weatherization program. Good decisions depend on judgment and ethics.

- ✓ Understand the policy of the DOE WAP program.
- ✓ Treat every client with the same high level of respect.
- ✓ Communicate honestly with clients, coworkers, contractors, and supervisors.
- ✓ Know the limits of your authority, and ask for guidance when you need it.
- ✓ Develop and maintain the inspection, diagnosis, and software skills necessary for WAP energy auditing.
- ✓ Choose ECMs according to their cost-effectiveness along with DOE and State policy, and not according to personal preference or client preference.
- ✓ Don't manipulate the energy-modeling software to either select or avoid particular ECMs.
- ✓ Avoid personal bias in your influence on purchasing, hiring, and contracting.

## 2.1.2 Health and Safety Considerations

Energy auditors and inspectors must know and understand the health and safety (H&S) policies of the State weatherization program. H&S measures impact the budget and the economic viability of most weatherization jobs. An auditor may justify a H&S measure as any of the following types according to WPN 17-7.

1. A required H&S measure funded by the State's H&S budget, which protects occupants or workers but isn't justified by the energy audit and isn't included in the average cost per unit (ACPU).
2. An incidental repair measure (IRM), with H&S benefits, funded to protect an ECM or to mitigate a relatively inexpensive hazard such as a roof leak, chimney repair, or electrical repair.

3. A H&S measure that serves as a precaution or a benefit of a cost-effective ECM, and in this case, the H&S measure adds costs to the SIR calculation.
4. A H&S benefit of an ECM that isn't itself cost-effective but justifiable by the H&S benefits combined with the ECM's energy savings.

When you consider whether a measure is an ECM or a H&S, evaluate its SIR, and if cost-effective, treat it as an ECM.

### 2.1.3 Energy-Auditing Record-keeping

The client file is the record of a weatherization job. The client file may contain all of the following items, depending on State WAP policy.

1. Client intake document
2. Income verification
3. Owner agreement form
4. Work plan
5. Client health-notification documents
6. Insulation identification and R-value
7. Energy-education documentation
8. Moisture and mold findings
9. Hold harmless statement
10. Solid fuel inspection report
11. Manufacturer's warranties
12. Photo documentation
13. Post-inspection report
14. EPA Lead-Safe Renovation, Repair and Painting (LSRRP) Rule, final-inspection report (if applicable)

## 2.2 CLIENT RELATIONS

Client satisfaction depends on the energy auditor's reputation, professional courtesy, and ability to communicate.

### 2.2.1 Communication Best Practices

Making a good first impression is important for client relations. Friendly, honest, and straightforward communication creates an atmosphere where the auditor and clients can discuss problems and solutions openly.

Setting priorities for client communication is important for the efficient use of your time. Auditors must communicate clearly and directly. Limit your communication with the client to the most important energy, health, safety, and durability issues.

- ✓ Introduce yourself, identify your agency, and explain the purpose of your visit.
- ✓ Make sure that the client understands the goals of the WAP program.
- ✓ Listen carefully to your client's reports, complaints, questions, and ideas about their home's energy efficiency.
- ✓ Ask questions to clarify your understanding of your client's concerns.
- ✓ Before you leave, give the client a quick summary of what you found.
- ✓ Avoid making promises until you have time to finish the audit, produce a work order, and schedule the work.
- ✓ Make arrangements for additional visits by crews and contractors as appropriate.

### 2.2.2 Client Interview

The client interview is an important part of the energy audit. Even if clients have little understanding of energy and buildings,

they can provide useful observations that can save you time and help you choose the right ECMs.

- ✓ Ask the client about comfort problems, including rooms that are too cold or too warm.
- ✓ Ask clients to see their energy bills if you haven't already evaluated them.
- ✓ Ask clients if there is anything relevant they notice about the performance of their mechanical equipment.
- ✓ Ask about family health, especially respiratory problems afflicting one or more family members.
- ✓ Discuss space heaters, fireplaces, attached garages, and other combustion hazards.
- ✓ Discuss drainage issues, wet basements or crawl spaces, leaky plumbing, and pest infestations.
- ✓ Discuss the home's existing condition and how the home may change after the proposed retrofits.
- ✓ Identify existing damage to finishes to insure that weatherization workers aren't blamed for existing damage. Document damage with digital photos.
- ✓ Ask the client to sign the necessary permissions.

### 2.2.3 Deferral of Weatherization Services

When you find major health, safety, or durability problems in a home, sometimes it's necessary to postpone weatherization services until those problems are solved. The problems that are cause for deferral of services include but aren't limited to the following.

- Major roof leakage.
- Major foundation damage.
- Major moisture problems including mold or insect infestation.

- Major plumbing problems.
- Human or animal waste in the home.
- Major electrical problems or fire hazards.
- The home is vacant or the client is moving.
- The home is for sale.

Behavioral problems may also be a reason to defer services to a client, including but not limited to the following.

- Illegal activity on the premises.
- Occupant's hoarding makes difficult or impossible to perform a complete audit.
- Lack of cooperation by the client.

### Matching Funds to Avoid Deferrals

Energy auditors should assist clients in obtaining repair funds from the following sources whenever possible.

- *HUD HOME Rehabilitation Funds for Homeowners*
- *HUD Home Repair Loans*
- *USDA Rural Development Housing Repair Funds*
- *Habitat for Humanity Home Preservation*
- State and local repair funds
- Church, charity, and foundation funds

## 2.3 PARTS OF AN ENERGY AUDIT

Visual inspection, diagnostic testing, and numerical analysis are three types of energy auditing procedures we discuss in this section. These procedures help energy auditors to evaluate all the possible ECMs that are cost-effective according to DOE-approved energy-modeling software: Weatherization Assistant

or approved equivalent. See “*Quantitative Analysis: Software*” on page 83.

To understand the features of Weatherization Assistant, consult the DOE *Weatherization Assistant training site*.

The energy audit must also propose solutions to health and safety problems related to the energy conservation measures.

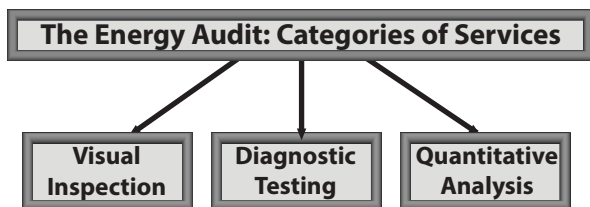

### 2.3.1 Visual Inspection

Visual inspection orients the energy auditor to the physical realities of the home and home site. Among the areas of inspection are these.

- Health and safety issues
- Building air leakage
- Building insulation and thermal resistance
- Heating and cooling systems
- Ventilation fans and operable windows
- Baseload energy uses
- The home’s physical dimensions: area and volume

### 2.3.2 Diagnostic Testing

Measurement instruments provide important information about a building’s unknowns, such as air leakage and combustion efficiency. Use these diagnostic tests as appropriate during the energy audit.



- Blower-door testing: A variety of procedures using a blower door to evaluate the airtightness of a home and parts of its air barrier.
- Duct leakage testing: A variety of tests using a blower door and pressure pan to locate duct leaks.
- Ventilation testing: Measure airflow through existing exhaust fans with an exhaust-fan flow meter.
- Combustion safety and efficiency testing: Sample combustion by-products and measure depressurization to evaluate safety and efficiency. Test for existing gas leaks. Test the home's ambient air for CO.
- Test for fuel leaks with a combustible gas detector.
- Infrared scanning: View building components through an infrared scanner to observe differences in the temperature of building components inside building cavities.
- Appliance consumption testing: Monitor refrigerators with a logging watt-hour meter to measure electricity consumption.



**Video: Measuring a home**— A summary of measuring a home identifying weatherization opportunities.

### 2.3.3 Quantitative Analysis: Software

Energy auditors currently use Weatherization Assistant (WA) or other DOE-approved energy monitoring software, to determine which ECMs have the highest Savings-to-Investment Ratio (SIR). The ECMs with the highest SIRs are at the top of the WA priority list for a particular home.

$$\text{SIR} = \text{LIFETIME SAVINGS} \div \text{INITIAL INVESTMENT}$$

DOE WAP and the State WAP program require that ECMs have an SIR greater than 1. Subgrantees must install ECMs with higher SIRs before or instead of ECMs with lower SIRs.

The auditor must collect information to inform decisions about which ECMs to choose.

- ✓ Measure the home's exterior horizontal dimensions, wall height, floor area, volume, and area of windows and doors.
- ✓ Measure the current insulation levels.
- ✓ Do a test to evaluate air leakage and duct leakage.
- ✓ Do a combustion efficiency test to evaluate the heating system's efficiency.
- ✓ Evaluate energy bills and adjust the job's budget within limits to reflect the potential energy savings.

## 2.4 WORK ORDERS

The work order is a list of materials and tasks that are recommended as a result of an energy audit. Consider these steps in developing the work order.

- ✓ Evaluate which ECMs have an acceptable savings-to-investment ratio (SIR) using the energy-modeling software.
- ✓ Select the most important health and safety problems to correct based on what problems are directly related to the cost-effective ECMs.
- ✓ Provide detailed ECM specifications so that crews or contractors clearly understand the materials and procedures necessary to complete the job.
- ✓ Estimate the cost of the materials and labor.
- ✓ Verify that the materials needed are in stock at the agency or a vendor.

- ✓ Inform crews or contractors of any hazards, pending repairs, and important procedures related to their part of the work order.
- ✓ Obtain required permits from the local building jurisdiction, if necessary.
- ✓ Specify interim testing during air sealing and heating-system maintenance to provide feedback for workers.
- ✓ Consider scheduling an in-progress inspection during an important retrofit.
- ✓ Consider scheduling a final inspection for the job's final day if possible to involve the workers in the inspection

## 2.5 QUALITY CONTROL INSPECTIONS

The quality-control inspector (QCI) is responsible for the quality control and quality assurance of the weatherization process. The Building Performance Institute (BPI) certifies QCIs to perform Subgrantee job inspections and Grantee (State) monitoring.

Grantees must follow DOE's QCI Policy or else submit their own QCI Policy for approval by DOE. Good inspections provide quality control for both work orders and energy audits. There are two common opportunities for inspections: in-progress inspections and final inspections.

### 2.5.1 In-Progress Inspections

DOE encourages QCIs to inspect jobs while the job is in progress. In-progress inspections evaluate worker safety, observe ongoing procedures, and provide training, technical assistance, and occupant education.

*See "Occupant Education about Alarms" on page 28.*

These measures are good candidates for in-progress inspections because of the difficulty of evaluating them after completion.

- Dense-pack wall insulation
- Attic air sealing
- Insulating closed roof cavities
- Furnace installation or tune-up
- Air-conditioning service
- Duct testing and sealing
- Lead-safe work practices

Rural in-progress inspections may require too much expensive travel and time, making in-progress inspections impractical except for the final inspections.

## 2.5.2 Subgrantee Final Inspections

The weatherization service provider or Subgrantee does final inspections on all of its weatherized homes for quality control. Quality control is a term for the in-house self-evaluation of weatherization jobs. A certified QCI completes a final inspection before the Subgrantee reports a weatherization job as a completion to the Grantee.

If the QCI is a different person from the energy auditor, the Grantee must perform independent reviews of 5% of DOE WAP units completed by the Subgrantee.

If the QCI is the same as from the energy auditor, the Grantee must perform independent reviews of 10% of DOE WAP units, completed by the Subgrantee. The Grantee must also develop a quality assurance plan that ensures that the individual who is functioning as both the auditor and the QCI is able to consistently perform both tasks.

Final inspections ensure that energy auditor identified the right ECMs, and that the crew and contractors installed the ECMs as specified in the work order.

## Energy-Audit Quality Control

While the work order is the more obvious priority of the inspection, quality control for the energy audit is nearly as important. Answer these questions during a final inspection.

- Did the auditor find all the ECM opportunities?
- Did the auditor identify all the health and safety concerns and worker safety hazards?
- Do the audit's ECMs comply with the computer analysis?

## Work-Order Quality Control

If you complete the final inspection with the crew or contractor on site, you can help workers to correct deficiencies without their returning to the home later. Ask these questions during your inspections.

- Did the energy audit find the best combination of ECMs for the home?
- Did the work order adequately specify the labor and materials required by the energy audit?
- Did the crew follow the work order?
- What changes did the crew leader make to the work order? Were these changes appropriate?
- Are the completed weatherization job, the energy audit, and the work order aligned with State policy, DOE policy, and the SWS?

Verify the following during the final QC inspection.

- ✓ Confirm that the crew installed the approved materials in a safe, effective, and neat way.
- ✓ Confirm that the crew matched existing finish materials for measure installation and necessary repairs.
- ✓ Review all completed work with the client. Confirm that the client is satisfied.

- ✓ Verify that combustion appliances operate safely. Do worst-case draft tests and CO tests as needed.
- ✓ Do a final blower-door test with simple pressure diagnostics if appropriate.
- ✓ Use an infrared scanner, if available, to inspect insulation and air-sealing effectiveness.
- ✓ Specify corrective actions whenever the work doesn't meet standards.
- ✓ Verify that the crew used the correct lead-safe procedures if these procedures were necessary in installing ECMs.
- ✓ Verify that all required paperwork, with required signatures is in the client file. *See “Energy-Auditing Record-keeping” on page 78.*

## 2.6 GRANTEE (STATE) MONITORING OF SUBGRANTEES

Quality control is an internal process of a weatherization service provider (Subgrantee) focusing on the final inspection. Quality assurance is a third-party inspection performed by a monitor employed by either the Grantee or a third party, working for the State.

Certified quality-control inspectors (QCIs) may perform quality-assurance inspections. The following are important elements of these inspections.

- Verify alignment among energy audit, work order, and final inspection.
- Report findings, concerns, and issues, and specify corrective action.
- Resolve any existing findings, concerns, and issues.
- Provide feedback on material quality and worker performance, both good and bad.
- Survey clients for level of satisfaction.

- Review the paperwork for completion and compliance.

## 2.6.1 DOE Monitoring of Grantees (States)

The DOE monitors the Grantees based on their State Plan and associated Health & Safety Plan, required for annual WAP funding application. The DOE Project Officer's (PO's) job is similar to the agency's QCI. However, the PO is a DOE employee and reports his or her monitoring results to the State Grantee and the DOE but not the Subgrantee. DOE monitoring is more administrative and less technical. The PO need not be a certified QCI.

POs interact with Grantees in these ways.

1. Advise Grantee how to continue to meet WAP program requirements.
2. Resolve outstanding findings, concerns, and issues.
3. Identify training and technical assistance needs.
4. Document strengths and weaknesses of the State program.
5. Document best practices for distribution to the WAP network, if appropriate.

The monitor issues a report and the Grantee must respond in writing. Major findings require the Grantee to tell the DOE how the Grantee plans to correct the problems and pay for the corrections.

## 2.7 UNDERSTANDING ENERGY USAGE

A major purpose of any energy audit is to determine where energy waste occurs. With this information in hand, the energy auditor then allocates resources according to the energy-savings potential of each energy-conservation measure. A solid understanding of how homes use energy should guide the decision-making process.

**Table 2-1: Top Six Energy Uses for U.S. households**

<b>Energy User</b>	<b>Annual kWh</b>	<b>Annual Therms</b>
<b>Heating</b>	2000–10,000	200–1100
<b>Cooling</b>	600–7000	n/a
<b>Water Heating</b>	2000–7000	150–450
<b>Refrigerator</b>	500–2500	n/a
<b>Lighting</b>	500–2000	n/a
<b>Clothes Dryer</b>	500–1500	n/a

Estimates by the authors from a variety of sources.

### 2.7.1 Baseload Versus Seasonal Use

We divide home energy usage into two categories: baseload and seasonal. Baseload includes water heating, lighting, refrigerator, and other appliances used year round. Seasonal energy use includes heating and cooling. You should understand which of the two is dominant as well as which types of baseloads and seasonal loads are the highest energy consumers.

Many homes are supplied with both electricity and at least one source of combustion fuel. Electricity can provide all seasonal and baseload energy, however most often there is a combination of electricity and natural gas, oil, or propane. The auditor must understand whether loads like the heating system, clothes dryer, water heater, and kitchen range are serviced by electricity or by fossil fuel.

Total energy use relates directly to potential energy savings. The greatest savings are possible in homes with highest initial consumption. Avoid getting too focused on a single energy-waste category. Consider all the individual energy users that offer measurable energy savings.



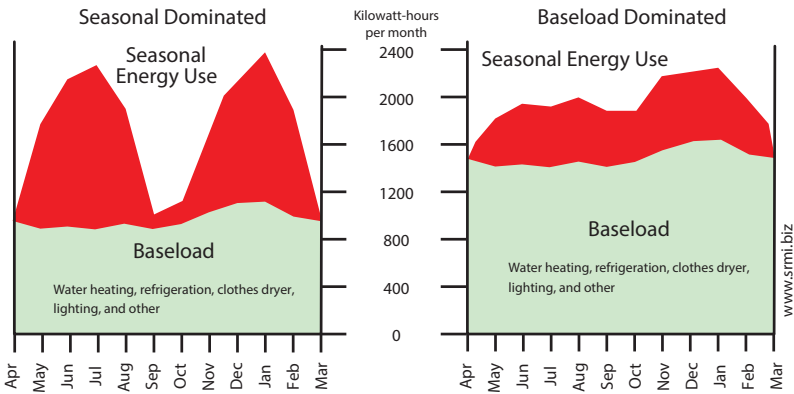

**Seasonal vs. Baseload Domination of Energy Use:** Homes with inefficient shells or in severe climates have large seasonal energy use and smaller baseload. More efficient homes and homes in mild climates are dominated by baseload energy uses.

## Separating Baseload and Seasonal Energy Uses

To separate baseload from seasonal energy consumption for a home with monthly gas and electric billing, do these steps.

1. Get the energy billing for one full year. If the client can't produce these bills, they can usually request a summary from their utility company.
2. Add the 3 lowest bills together.
3. Divide that total by 3.
4. Multiply this three-month low-bill average by 12. This is the approximate annual baseload energy cost.
5. Total all 12 monthly billings.
6. Subtract the annual baseload cost from the total billings. This remainder is the space heating and cooling cost.
7. Heating is separated from cooling by looking at the months where the energy is used — summer for cooling, winter for heating.

8. For cold climates, add 5 to 15 percent to the baseload energy before subtracting it from the total to account for more hot water and lighting being used during the winter months.

**Table 2-2: Separating Baseload from Seasonal Energy Use**

<b>Factor and Calculation</b>	<b>Result</b>
<b>Annual total gas usage from utility bills</b>	<b>1087 therms</b>
Monthly average gas usage for water heating Average of 3 low months gas usage $(21 + 21 + 22) \div 3 = 21.3$ therms per month	21.3 therms per month
<b>Annual gas usage for water heating</b> Monthly average usage multiplied by 12 $12 \times 21.3 = 256$ therms per year	<b>256 therms per year</b>
<b>Annual heating gas usage</b> Annual total minus annual water-heating usage $1087 - 256 = 831$ therms per year	<b>831 therms per year</b>
<b>Annual total electric use from utility bills</b>	<b>6944 kWh</b>
Monthly average usage for electric baseload Average of 3 low months electricity usage $(375 + 372 + 345) \div 3 = 364$ kWh per month	364 kWh per month
<b>Annual electric usage for baseload</b> Monthly average usage multiplied by 12 $12 \times 364 = 4368$ kWh per year	<b>4368 kWh per year</b>
<b>Annual heating and cooling electrical usage</b> Annual total minus annual baseload usage $6944 - 4368 = 2576$ kWh per year	<b>2576 kWh per year</b>

## 2.7.2 Energy Indexes

Energy indexes are useful for comparing homes and characterizing their energy efficiency. They are used to measure the

opportunity for application of weatherization or home performance work.

Most indexes are based on the square footage of conditioned floor space. The simplest indexes divide a home's energy use in either kilowatt-hours or British thermal units (BTUs) by the square footage of floor space.

A more complex index compares heating energy use with the climate's severity. BTUs of heating energy are divided by both square feet and heating degree days to calculate this index.

## 2.8 CLIENT EDUCATION

Client education is a potent energy conservation measure. A well-designed education program engages clients in household energy management and assures the success of installed energy conservation measures (ECMs).



# CHAPTER 3: WEATHERIZATION MATERIALS

This chapter focuses on materials for insulation and air sealing. Our first topics include introductory information on air sealing, air sealing materials, insulation building science, and insulation materials. This information supports the next four chapters on the major parts of the building shell.

**Note about fire testing:** The IRC requires certain fire tests for weatherization materials. The numbered fire tests used in this chapter refer to a building material's certification by virtue of passing that particular fire test. We present these references, such as ASTM E-84, for you to identify a certified building product. The product should display the number of the test on its label or in its specifications. For more information on the tests referenced in this chapter, see *"Fire Testing and Rating" on page 569*.

## 3.1 AIR-SEALING GOALS

Perform air leakage testing and evaluation before beginning air-sealing or duct-sealing work. Always evaluate ventilation and perform combustion-safety testing as a part of air sealing a building. However don't limit air sealing by ventilation requirements, but only by the cost effectiveness of air-sealing efforts. *See "ASHRAE Standard 62.2-2016 Ventilation" on page 414.*

Reducing air leakage accomplishes several goals.

- Saves energy by reducing unintentional air exchange with outdoors
- Reduces air leakage and convection around insulation, protecting its thermal resistance
- Enhances comfort by minimizing drafts
- Minimizes moisture migration into building cavities

- Reduces the pathways where fire can propagate through a building
- Reduces the infiltration of dust and small particulates from outdoors

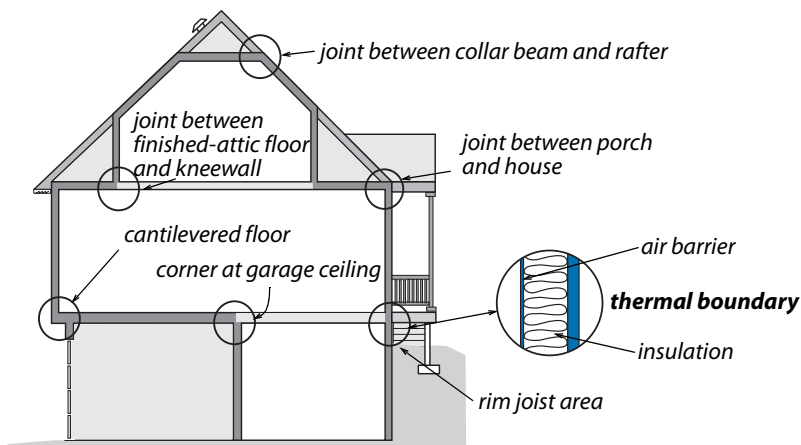

**Air leaks at the thermal boundary:** The air barrier and insulation, which should be adjacent to one another, are located at the thermal boundary. The insulation and the air barrier are often discontinuous at corners and transitions.

## 3.2 AIR SEALING SAFETY

### *SWS Detail: 3.0 Air Sealing*

Air sealing reduces the exchange of fresh air in the home, and can alter the pressures within the home. Before air sealing, survey the home to identify both air pollutants that may be concentrated by air sealing efforts and open combustion appliances that may be affected by changes in house pressure.

Don't do air sealing when there are obvious threats to the occupants' health, the installers' health, or the building's durability that are related to air sealing. If any of the following circumstances are present, either postpone air sealing until they're corrected or correct the problems as part of the air-sealing work.

- Measured carbon monoxide levels exceed the suggested action level. *“Carbon Monoxide (CO) Testing” on page 271*
- Combustion zone depressurization exceeds the limits shown in *“Maximum CAZ Depressurization” on page 570* during a worst-case test. *See “Worst-Case CAZ Depressurization Testing” on page 274.*
- Occupants will use unvented space heaters as a primary source of heat after weatherization is complete.
- The air-leakage area has moisture damage, indicated by staining, mold or rot.

### 3.2.1 Air Sealing and Fire Containment

*SWS Detail: 3.0101 General Air Sealing; 3.0102 Specific Air Sealing*

Fire, flame, and smoke spread through the paths of least resistance. Many building assemblies harbor concealed voids or cavities within walls, ceilings, and attics. During a fire, these pathways spread fire and make fire-fighting difficult.

In new buildings, the IRC requires builders to seal all shafts and hidden air leaks between living spaces and intermediate zones with fire-blocking materials.

The building codes define a fire-block as a material installed to “resist the free passage of flame through concealed spaces.” Fire-blocking materials need not be non-combustible.

We recommend rigid fire-blocking materials such as the following ones suggested in the IRC.

- Plywood, OSB or other wood sheeting ( $\frac{3}{4}$  inch thick)
- Drywall ( $\frac{1}{2}$  or  $\frac{5}{8}$  inch thick)
- Mortar, reinforcing material, and compatible non-combustible caulking to air seal masonry building assemblies.

## 3.3 AIR SEALING MATERIALS

*SWS Detail: 3.0101 General Air Sealing; 3.0102 Specific Air Sealing*

Air barriers must resist severe wind pressures. Use strong air-barrier materials like structural wood paneling, drywall, or sheet metal to seal large air leaks, especially if your region has powerful winds. Attach these strong materials with mechanical fasteners and seal them with caulk or adhesive. If a technician needs to access a shaft or penetration in the future, use a caulk that isn't a strong adhesive, such as acrylic latex.

Use caulk by itself for sealing small cracks. Use liquid foam for cracks larger than  $\frac{1}{4}$  inch.

### 3.3.1 Material and Sealant Specs

Select materials and sealants that meet these SWS specifications.

1. Be compatible with their intended surfaces.
2. Allow for differential expansion and contraction between dissimilar materials.
3. Remove any material from the sealing area that could prevent full adhesion of the selected sealant.
4. Comply with the requirements of the applicable fire-safety code.
5. For indoor application, select low volatile-organic-compound (VOC) sealants.
6. For small holes (less than  $\frac{1}{4}$  inch), install backing or infill material at least  $\frac{1}{8}$  inch below the surface where you install the sealant.
7. For medium holes ( $\frac{1}{4}$  inch to 3 inch), install backing or infill in or over all holes that you seal.



8. For large holes (greater than 3 inches), install rigid backing or infill in or over all holes that you seal.
9. Install support material for spans wider than 24 inches, except when air barrier material is rated to span more than 24 inches under load from wind or insulation.
10. Install only noncombustible materials and sealants with an ASTM E136 listing in contact with any device producing 200 degrees F or more — chimneys, vents, light fixtures, and flues, for example.



**Video: Air sealing a home**— Methods and materials for air sealing site-built homes.

### 3.3.2 Air-Barrier Materials

Air-barrier materials should themselves be air barriers and also rated as fire blocks. *See Table 12-1 on page 557.*

Plywood, OSB, etc.

Three-quarter-inch plywood, OSB, and particle board are IRC-approved fire-blocking materials, and they're strong enough to resist windstorms. Attach these structural sheets with screws or nails along with any sealant or adhesive that effectively air seals the joint.

Drywall

Half-inch drywall constitutes a 15 minute thermal barrier, and is also an ignition barrier. When air sealing a fire-rated assembly in a commercial or multi-family building, choose five-eighths - inch drywall and a fire-rated caulking. Fasten drywall with screws and construction adhesive. Don't use drywall in damp locations where it may get wet.

## Steel and Aluminum Sheet Metal

Installers use non-combustible sheet metal to seal around chimneys and other heat producing components. To seal around chimneys, cut the sheet metal accurately, with less than a  $\frac{1}{8}$ -inch gap, so that you can seal the gap with high temperature, non combustible caulk labeled ASTM E136.

## Foam Board

Foam board may be a desirable product for air sealing; however it has less structural strength and fire resistance than the other materials discussed previously.

## Cross-Linked Polyethylene House Wrap

House wrap and polyethylene sheeting are air barriers. These flexible materials aren't rated as fire-blocks, and they are structurally weak.

### 3.3.3 Stuffing Materials

Stuffing materials are used to insulate a cavity, to give the cavity a bottom, or to serve as supporting part of an air seal.

## Backer Rod

Backer rod and caulking are the most reliable and long-lasting air seals. Backer rod is closed-cell polyethylene foam that creates a bottom barrier in a gap before caulking. Backer rod doesn't bond to the caulking, and so prevents three-sided adhesion that could tear the caulking bead apart with the materials' expansion and contraction of temperature extremes.

## Fiberglass Batts

Fiberglass batts reduce air convection in cavities where they're installed. However, fiberglass batts are air permeable, even if compressed. Batts can support two-part foam sprayed over the opening of a cavity. Fiberglass batting is a good stuffing material

for use with non-combustible caulk for penetrations through fire-rated assemblies because of its low combustibility.

### Blown Cellulose or Fiberglass

Blown cellulose and fiberglass reduce air convection and air leakage through closed cavities. However neither material is an air barrier even when blown at high densities. Both are considered fire-blocks when installed in closed cavities because they block the passage of flames.

### 3.3.4 Caulking and Adhesives

The adhesion and durability of caulking and adhesives depends on their formulation and on the surfaces to which they're applied. Some caulks and adhesives are sensitive to dirt and only work well on particular surfaces, while others are versatile and dirt-tolerant. Remove debris and clean the joint to prepare the surfaces for caulking.

#### Water-Based Caulks

A wide variety of paintable caulks are sold under the description of acrylic latex and vinyl. These are the most commonly used caulks and the easiest to apply and clean up. Siliconized latex caulks are among the most adhesive and durable sealants in this group. Don't apply water-based caulks to building exteriors when rain is forecast since they aren't waterproof until cured, and they stain nearby materials if they are rained upon while curing. Don't apply water-based caulks during freezing weather.

#### Silicone Caulk

Silicone has great flexibility, but its adhesion varies among different surfaces. Silicone is easy to gun even in cold weather. Silicone isn't as easy to clean up as water based caulks, though it's easier than polyurethane or butyl. Silicone isn't paintable, so choose an appropriate color. High-temperature silicone may be

used with galvanized steel to air seal around chimneys if labeled ASTM E136, meaning that the caulk is non-combustible.

### Polyurethane Caulk

Polyurethane has the best adhesion and elasticity of any common caulk. It works well for cracks between different materials like brick and wood. Polyurethane resists abrasion and is used to seal critical joints in concrete slabs and walls. Polyurethane is also useful for sealing the fastening fins of windows to walls. Polyurethane is almost as sticky and adhesive as a construction adhesive. Cleaning it up is difficult so neat workmanship is essential. Polyurethane caulk doesn't gun easily, and should be room temperature or higher. Polyurethane caulk doesn't hold paint.

### Acoustical Sealant

This solvent-based or water-based adhesive is used to seal laps in polyethylene film and house wrap. Acoustical sealant is very sticky, adheres well to most construction materials, and remains flexible. Acoustical sealant is used to seal building assemblies for sound deadening. Acoustical sealant is also used to seal the seams of polyethylene vapor barriers and ground-moisture barriers.

### Water Soluble Duct Mastic

Duct mastic is the best material for sealing ducts, including cavities used for return ducts. A messy but highly effective sealant, duct mastic can be applied with a thickness of  $\frac{1}{8}$ -inch with a brush or rubber glove. Have a bucket of warm water handy to clean your gloved hands and a rag to dry the gloves. Spread the mastic and use fiberglass fabric web tape to reinforce cracks more than  $\frac{1}{8}$ -inch in diameter. Thorough cleaning of dust and loose material isn't necessary. Mastic bonds tenaciously to everything, including skin and clothing.

## Stove Cement

Stove cement is a material that can withstand temperatures up to 2000° F. Use stove cement to seal wood stove chimneys and to cement wood-stove door gaskets in place.

## Non-Combustible Caulk

Some elastomeric caulks are designed specifically for use in fire-rated assemblies. They are labeled ASTM E136, meaning that the caulk is non-combustible. Use this type of sealant when sealing penetrations through fire-rated assemblies in multifamily buildings.

## Fire-Rated Mortar

Used with other air-sealing materials to seal various sized holes and gaps in multifamily buildings with fire-rated masonry building assemblies. This mortar often covers a foam air sealant to create a non-combustible surface for a combustible air seal.

## Construction Adhesives

Construction adhesives are designed primarily to bond materials together. But they also create an air seal if applied continuously around the perimeter of a rigid material. They are often used with fasteners like screws or nails but can also be used by themselves. Some construction adhesives act like contact adhesives to bond lightweight materials without mechanical fasteners.

Use specially designed construction adhesives for polystyrene foam insulation because many general-purpose adhesives decompose the foam's surface.

### 3.3.5 Liquid Foam Air Sealant

Liquid closed-cell polyurethane foam is a versatile air sealing material in addition to an insulation material. Closed-cell foam is packaged in a one-part injectable variety and a two-part

spray-able variety. This SPF has a high R-value per inch and is ideal for insulating and air sealing in a single application.

Liquid-foam installation is easy compared to other materials to accomplish the same air sealing tasks. However, cleanup is difficult enough that you probably don't want to clean up multiple times on the same job. Instead identify all the spots needing foam application, make a list, and foam them one after another.

For all its convenience, liquid foam's durability as an air seal is questionable. Cracks in the foam tend to occur at cracks in the air-sealed material.

### One-Part Foam

This gap filler has tenacious adhesion. One-part foam is best applied with a foam gun rather than the disposable cans. Cleanup is difficult if you're careless. When applied skillfully into gaps, one-part foam reduces air leakage, thermal bridging, and air convection. One-part foam isn't effective or easy to apply to gaps over about one inch or to bottomless gaps. This product can leave small air leaks because it cracks when the materials around it move or shift.

### Two-Part Foam

Good for bridging gaps larger than one inch, this product is also known as low-density spray polyurethane foam (SPF). Two-part foam is popular for use with rigid patching materials to seal large openings. Cut foam board to as closely as possible around obstacles and fill the edges with the two-part foam. Two-part foam should be sprayed to at least an inch of thickness when it serves as an adhesive for foamboard patches over large holes for strength.

### Foam Construction Adhesive

Polyurethane foam dispensed from foam guns is an excellent adhesive for joining many kinds of building materials. Foam

adhesive works well for joining foam sheets together into thick slabs for vertical access doors and attic hatches.



**One-part foam:** A contractor uses an applicator gun to seal spaces between framing members and around windows.



**Two-part foam:** A contractor air-seals and insulates around an attic hatch dam with two-part spray foam.

### 3.4 INSULATION BUILDING SCIENCE

Insulation reduces heat transmission by resisting the conduction, convection, and radiation of heat through the building shell. Insulation combined with an air barrier creates the thermal envelope between the conditioned indoors and outdoors.

Installing insulation is one of the most effective energy-saving measures. You can ensure insulation's safety and effectiveness by following these guidelines.

- ✓ Install insulation in a way that enhances fire safety and doesn't degrade it. *See "Safety Preparations for Attic Insulation" on page 141.*
- ✓ Comply with lead-safe practices when disturbing paint in pre-1978 homes. *See "Additional Lead-Safe Work Practices" on page 52.*
- ✓ Prevent air movement through and around the insulation with an effective air barrier. Make sure that the air barrier and insulation are aligned (next to one another) using procedures outlined starting on *page 123.*
- ✓ Protect insulation from moisture by repairing roof and siding leaks, providing site drainage, and by controlling vapor sources within the home. *See "Solutions for Moisture Problems" on page 36.*
- ✓ Install insulation to meet or exceed the guidelines of the 2018 International Energy Conservation Code (IECC) and the DOE's Standard Work Specifications.

### 3.4.1 Insulation Receipt or Certificate

Provide each client receiving insulation products and services, a printed and signed receipt or certificate that includes the following information.

- Insulation type
- Coverage area
- Number of bags installed
- R-value
- Installed thickness and settled thickness
- Amount of insulation installed according to manufacturer's specifications



## 3.5 INSULATION MATERIAL CHARACTERISTICS

### SWS Detail: 4.0 Insulation

The purpose of insulation is to provide thermal resistance that reduces the rate of heat transmission through building assemblies. Characteristics such as R-value per inch, density, fire safety, vapor permeability, and airflow resistance help weatherization specialists choose the right insulation for the job.

### 3.5.1 Fibrous Insulation Materials

Fibrous insulation materials are the most economical insulations for buildings. If blown at a high density, fibrous insulations aren't air barriers themselves, but they may contribute to the airflow resistance of a building assembly that functions as an air barrier. The term *mineral wool* describes both fiberglass and *rock wool*. Rock wool is both a generic term and a trade name. We use rock wool in the generic sense as an insulating wool spun from rocks or slag. Fiberglass is wool spun from molten glass.

Cellulose was once made from virgin wood fiber under trade names like Balsam Wool. Now cellulose is manufactured primarily from recycled paper, treated with a fire retardant.

A vapor permeable air barrier should cover fibrous insulation installed vertically or horizontally in human-contact areas to limit exposure to fibers, which may cause respiratory distress.

#### Fiberglass Batts and Blankets

Most fiberglass batts are either 15 inches wide or 23 inches wide to fit 16-inch or 24-inch spacing for wood studs or joists. However, manufacturers also provide 16-inch or 24-inch widths for metal stud construction.

The advertised R-values of batts vary from 3.1 per inch to 4.2 per inch depending on density. Installed fiberglass R-values may

be 5% to 30% less than advertised depending on installation quality and the effectiveness of the assembly's air barrier.

**Evaluating batt performance:** The thermal performance of batts depends on density and installation.

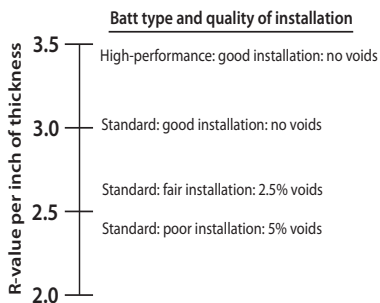

Installers must cut and fit batts very carefully. Batt s achieve their advertised R-value only when they are touching all six sides of the cavity it inhabits.

See *“Open-Cavity Wall Insulation”* on page 195.

Fiberglass blankets are typically three to six feet wide. Blankets come in a variety of thicknesses from 1 to 6 inches. Fiberglass blankets are used to insulate metal buildings, to insulate crawl spaces from the inside, and to insulate water heaters.

Although fiberglass doesn't absorb much moisture, the facings on blankets and batts can trap water in the batts, which can dampen building materials and provide a water source for pests.

### Facings for Fiberglass Batt s

Insulation manufacturers make batts and blankets with a number of facings, including the following.

- Unfaced: Vapor permeable and Class-A fire rating of  $\leq 25$  flame spread.
- Kraft paper: A Class II vapor retarder that is flammable (Class-C or Class 3) with a flame spread  $\geq 150$ .
- Foil-kraft: foil bonded to kraft paper. A vapor barrier with a flame spread of  $>75$  (Class-C or Class 3).

- Foil-skrim-kraft (FSK): Aluminum foil bonded to kraft paper with skim netting in-between as reinforcement. A vapor barrier available as a Class-A material with a flame spread of  $\leq 25$ .
- White poly-skrim-kraft (PSK): White polyvinylchloride bonded to kraft paper with skim netting in-between as reinforcement. A vapor barrier available as a Class A fire-rated material with a flame spread of  $\leq 25$ . The white surface maximizes light reflection.

## Blown Fiberglass

Loose fiberglass is blown in attics from 0.3 to 0.8 pcf and at that density range, the R-value is around 2.9 per inch. Expect around 5% settling within five years after installation.

Blown fiberglass is non-combustible as a virgin product. However, some blown fiberglass is made from chopped batt waste that contains a small amount of combustible binder.

Fiberglass manufacturers now provide two blowing products, one for standard densities of up to about 1.4 pcf, and another for dense-packing to more than 2.0 pcf.

In closed cavities, installers blow fiberglass from 1.2 to 2.2 pcf, with the R-value per inch varying from 3.6 to 4.2. Higher density achieves a higher R-value. The high-density fiberglass is typically reserved for walls where the superior resistance to settling, airflow, and convection has extra value over lesser density.

## Blown Cellulose

Cellulose is the most inexpensive insulation and among the easiest insulations to install. Loose cellulose is blown in attics from 0.6 to 1.2 pcf and at that density range, the R-value is around 3.7 per inch. Expect around 15% settling within five years after installation.

In wall cavities, cellulose is blown at a higher density of between 3.5 to 4.0 pcf, to prevent settling and to maximize its airflow

resistance. At that high density, cellulose's R-value per inch is around 3.4. Evaluate the strength of wall cladding before blowing a wall with cellulose to prevent damage during installation.

Cellulose absorbs up to 130% of its own weight in water. Before anyone discovers a moisture problem, the cellulose could be soaked, shrunken, double its dry weight, and far less thermally resistant. Avoid using cellulose in regions with an annual average precipitation of more than 50 inches or an annual average relative humidity of more than 70%. We believe that cellulose shouldn't be installed in the following places regardless of climate.

- Horizontal or sloped closed roof cavities
- Floor cavities above crawl spaces or unconditioned basements
- Crawl space walls or basement walls

## Rock Wool

Rock wool is a type of mineral wool like fiberglass. Rock wool has a small market share in North America. Rock wool batts have similar R-values per inch as fiberglass batts and contain flammable binders. Rock wool itself is non-combustible so blown rock wool doesn't burn.

Rock wool is also the most moisture-resistant insulation discussed here. In rainy and humid climates, rock wool is the least likely insulation to harbor moisture or support pests.

## Damp Spray Fibrous Insulation

Installers mix fibrous insulation with sprayed water and a small amount of adhesive in damp-spray applications either in open cavities or directly adhered to building surfaces. Sprayed cellulose contains a non-corrosive fire retardant to prevent metal corrosion when used in contact with metal building components.

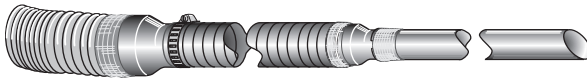

**Insulation hoses, fittings, and the fill tube:** Smooth, gradual transitions are important to the free flow of insulation.

## 3.6 INSULATION BLOWERS AND HOSES

The quality and ease of a wall dense packing job depends on the blowing equipment and the skills of the installers. Dense packing requires experienced installers and good equipment, kept in good working order.

### 3.6.1 Inexpensive Blowers

Manufacturers make a variety of inexpensive blowers for small contractors and for hardware dealers to rent to do-it-yourselfers. If these blowers are maintained, they can do an adequate job on easy insulation-blowing projects.

Some inexpensive insulation machines use a single control for both the feed and the air. This control strategy isn't as good as being able to control the feed in the air separately. Also, the agitator may merely stir the insulation, resulting in inefficient insulation flow.

### 3.6.2 Professional Blowers

For professionals who often insulate closed cavities, modern air-lock machines are essential. Either electricity or fuel engines power these professional blowing machines. You can stop insulation from entering the tube by shutting down the agitator. The blowing air continues to empty the hose. This independent control is an advantage in achieving the correct density and complete coverage in every closed building cavity, while minimizing spillage.

### 3.6.3 Main Parts of Insulation Blowers

Installers should be familiar with the main parts of insulation-blowing machines. Blowing machines require periodic maintenance, especially to the airlock's vane seals, which wear out with use.

#### Blower Motors

Blowers move air through the airlock, forcing insulation through the airlock into the blower hose. The blowing machine should match the power of the machine's blower or blowers to the typical jobs that the insulation contractor does. Wet spray fibrous insulation requires more blower power than dry applications. Long hose lengths also demand more blower power to maintain efficient installation rates (bags per hour).

#### Agitators or Augers

Agitators or augers break up the compressed insulation into small clumps and individual fibers. The agitators of some blowing machines actively force the insulation into the airlock. This feature has an advantage over agitators and hoppers that depend on gravity to fill the airlock.

X-FLOC

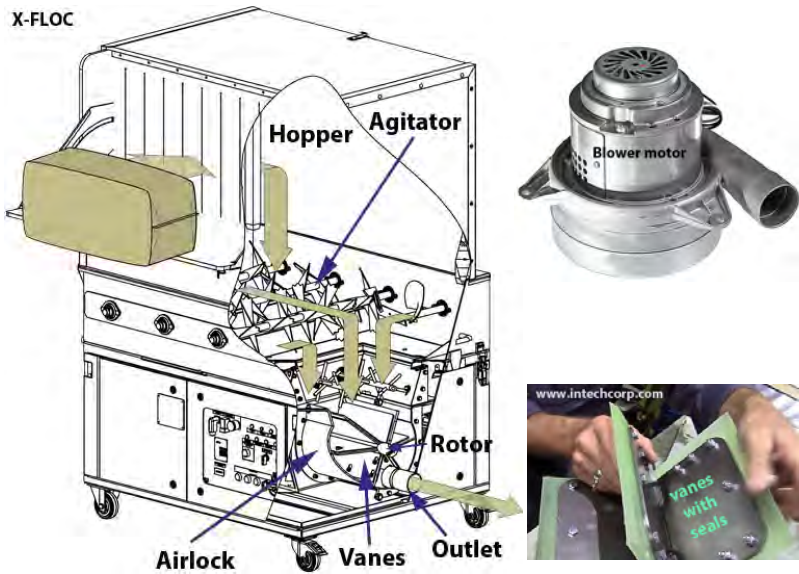

## Airlocks

The airlock is a cylinder with a rotor that drives a set of rotating vanes. The vanes seal tightly to the cylinder and lock the blower's air pressure away from the atmosphere outside the airlock. Insulation fills the triangular area between vanes and rotates until it reaches the outlet, where the blower forces it into the blower hose.

The airlock's size determines how many bags per hour that the machine blows. The agitator, along with gravity, must keep the airlock full of insulation for the machine to provide efficient operation.

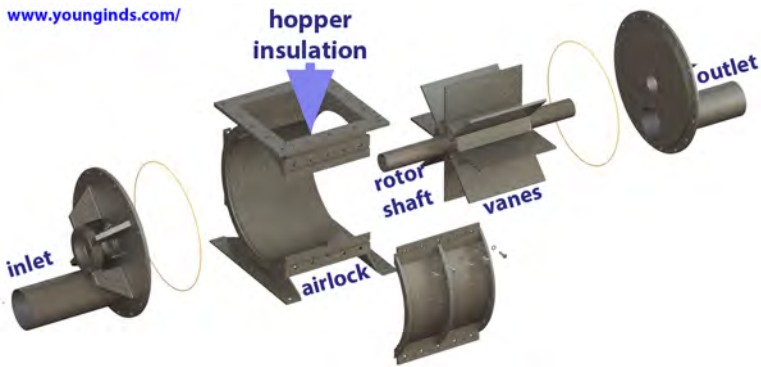

## Feed gates

Feed gates regulate the flow of the insulation into the airlock. They determine the amount of area that the insulation moves through to get inside the airlock. The area created by the feed gate varies, depending on the type of insulation and insulation job.

## Remotes

There are two types of remotes: remotes with cords and cordless remotes. Remotes control the blower and the agitator. The better machines allow the insulation installer to control the blower and the agitator independently by remote control.

## 3.6.4 Operating the Insulation Blowing Machines

Perform these important steps before and during insulation-blowing.

- ✓ Verify that the electrical source can provide the ampere draw of the insulation machine.
- ✓ Measure the pressure created by a blowing machine by connecting the hose to a fitting attached to a pressure gauge. Close the feed gate, and turn the air to the highest setting. For cellulose, the blowing machine should develop at least 2.9 pounds per square inch (psi) or 80 inches of



water (IWC) of pressure for dense-packed cellulose. Dense-packed fiberglass may require up to 4.0 psi or 110 IWC, depending on the type of fiberglass and the design of the blowing machine.

- ✓ Verify that you're blowing the correct density of fibrous insulation by using the bag's weight or the manufacturer's coverage tables.
- ✓ Control the agitator and the blower separately, if you can, to achieve adequate coverage and density, and also to minimize spillage.

**Important Note:** Dense-packed fibrous insulation can reduce air leakage and convection in closed building cavities. However, don't use dense-packed fibrous as a substitute for the air-sealing techniques described throughout this guide.

**Blower pressure gauge:** For blowing closed cavities, blower pressure should be at least 80 IWC or 2.9 psi. Measure the pressure with maximum air, feed gate closed, and agitator on.



### 3.6.5 Foam Board Insulation

Foam board is combustible and creates toxic smoke if it burns. Foam insulation usually requires covering with a thermal barrier or an ignition barrier.

Foam board, although not an insect food, is an insect-friendly material that can aid termites in establishing colonies in wood structures. Mitigate all sources of ground water before installing foam near a foundation. When foam is installed on the outside of foundations, the surrounding soil should be treated with a termiticide. Inside a crawl space, foam must never provide a

direct link from the ground to wood materials where termites or carpenter ants are common. The IRC forbids foam below grade in “very heavy” termite-colonized regions; the foam must be kept 6 inches above grade.

### Expanded Polystyrene (EPS) Foam Board

EPS foam board, sometimes called beadboard, is the most inexpensive of the foam insulations. EPS varies in density from 1 to 2 pcf with R-values per inch of 3.9 to 4.7, increasing with greater density. EPS is packaged in a wide variety of products by local manufacturers. Products include structural insulated panels (SIPS), tapered flat-roof insulation, EPS bonded to drywall, and EPS embedded with fastening strips.

EPS is flammable and produces toxic smoke when burned. EPS has a low maximum operating temperature (160 degrees F) — a concern for using EPS under dark-colored roofing or siding. EPS shrinks in some high-temperature installations.

EPS is very moisture resistant and its vapor permeability is similar to masonry materials, which makes EPS a good insulation for masonry walls.

Dense EPS (2 pcf) is appropriate for use on flat roofs and below grade. Dense EPS is also more dimensionally stable and less likely to shrink. Use weatherproof coverings to prevent degradation by ultraviolet light and freezing and thawing at ground level.

### Extruded Polystyrene (XPS) Foam Board

XPS is produced by only a few manufacturers and is popular for below-grade applications. XPS is more expensive than EPS and has an R-value of 5.0 per inch. XPS may be the most moisture-resistant of the foam boards.

XPS is flammable and produces toxic smoke when burned. XPS must be covered by a thermal barrier when installed in living spaces. XPS has a low maximum operating temperature (160

degrees F) that is a concern for using XPS under shingles or dark-colored siding. XPS has shrunken in some installations. Use weatherproof coverings to prevent degradation by ultraviolet light and freezing and thawing at ground level.

### Polyisocyanurate (PIC) Foam Board

PIC board has the highest R-value per inch (R-6 or a little more) of any common foam board. PIC is packaged with a vapor permeable facing or an aluminum-foil (vapor barrier) facing. PIC is expensive but worth the cost when the thickness of insulation is limited.

PIC is combustible and produces toxic smoke during a fire. However some products have fire retardants that allow installation in attics and crawl spaces without a thermal barrier or ignition barrier.

PIC has a low maximum operating temperature (<200 degrees F) that may be a concern for using PIC under dark-colored roofing or siding. Use the high-density (3 pcf) PIC board for low-sloping roof insulation.

### Polystyrene Beads

Polystyrene (EPS) beads can be poured or blown into cavities. The cavities must be airtight or the beads escape, making an annoying mess. EPS beads have an R-value between 2.2 and 2.5 per inch. Beads work well for filling hollow masonry walls.

### Vermiculite and Perlite

These expanded minerals are pour-able and used when a non-combustible insulation or high temperature insulation is needed. R-value per inch is between 2.0 and 2.7 per inch. These products are good for insulation around single-wall chimney liners to prevent condensation in the liner. Existing vermiculite may contain asbestos, and it must not be disturbed by anyone except a licensed asbestos abatement specialist.

## 3.7 INSULATION SAFETY AND DURABILITY

### SWS Detail: 4.0 Insulation

Insulation activities require awareness about safety. Reference the following safety-related sections of this guide if necessary.

- ✓ See “Asbestos Containing Materials (ACM)” on page 47.
- ✓ See “Decommissioning Knob-and-Tube Wiring” on page 55.
- ✓ See “Respiratory Health” on page 62.

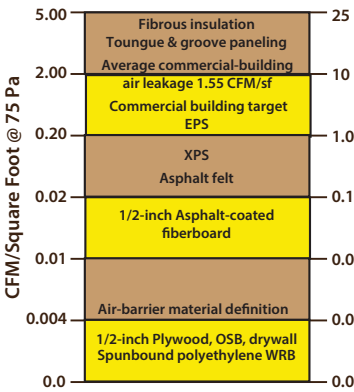

Air Permeability of Materials and Assemblies

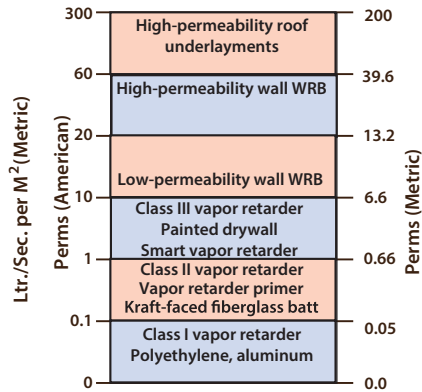

Vapor Permeability of Materials and Assemblies

### 3.7.1 Insulation Durability

Moisture is the most common and severe durability problem in insulated building assemblies. Moisture fosters rot by insects and microbes. Entrained moisture reduces the thermal resistance of many insulation materials. Moisture affects the chemistry of some building materials: metals for example.

Moisture prevention includes denying moisture access to building cavities, allowing condensed water to drain out, and allowing moisture to dry to the indoors, outdoors, or both.

Retrofitting insulation can affect the preventive measures listed here. Consider the function and relevance of these building components whenever you install insulation.

- **Air barrier:** Air can carry moisture into building cavities from indoors or outdoors where the moisture can condense and dampen insulation and other building materials. Air leakage is an energy problem too. The air barrier is any continuous material or building assembly that provides acceptable resistance to air leakage. *See “Air Permeability of Materials and Assemblies” on page 118.*
- **Vapor retarder:** Vapor diffusion can carry large amounts of water vapor into building cavities where it can condense and dampen insulation and other building materials. Vapor retarders resist water vapor diffusion from indoors into cavities where condensation can dampen insulation and other building materials. *See “Vapor Permeability of Materials and Assemblies” on page 118.*
- **Vapor barrier:** A very effective vapor retarder. A vapor retarder with a perm rating of less than 0.1 perms.
- **Ground-moisture barrier:** The ground under a building is the most potent source of moisture in many buildings, especially those built on crawl spaces. Most crawl spaces require ground-moisture barriers to prevent the ground from being a major cause of moisture problems.
- **Water-resistive barrier (WRB):** Asphalt paper or house wrap, under siding and roofing, serves as the home’s last defense to wind-driven rain, which can dampen sheathing and other building materials. This water resistive barrier must be protected during insulation and incorporated into window openings during window replacement.
- **Vapor permeable materials:** Most common building materials are permeable to water vapor, which allows the water vapor to follow a gradient from wet to dry. This process allows building assemblies to dry out to both indoors

and outdoors. Vapor permeable materials are essential for fail-safe building assemblies in most climates. *See “Vapor Permeability of Materials and Assemblies” on page 118.*

- **Flashings:** Seams and penetrations in building assemblies are protected by flashings, which prevent water from entering these vulnerable areas.
- **Drainage features:** Intentional or unintentional drainage features of buildings allow water to drain out of cavities. Examples: Masonry veneers have intentional drainage planes and weep openings near their bottoms. Cathedral ceilings drain water out through their soffit vents unintentionally.
- **Water storage:** Masonry veneers and structural masonry walls have the ability to store rainwater and dry out during dry weather.
- **Ventilation:** Roofs, attics, crawl spaces and even some walls have ventilation features that dry out wet building assemblies.
- **Termiticide:** When foam insulation is installed below grade in regions with termites, apply a termiticide to the soil in amounts determined by the labeling of the termiticide.

Consult with experts when necessary to preserve, protect, or install these moisture-prevention features, according to local climate and established best practices.

### 3.8 SHADING MATERIALS AND METHODS

*SWS Detail: 5.0401.1 Indigenous Shading; 5.0402.1 Reflective Roof Coatings*

Shading is the final envelope-material consideration of this chapter. A significant percent of buildings overheat during the

summer, and most of that excess heat comes from solar radiation.

Most solar radiation falling on a building affects the roof and the windows. Three shading approaches are appropriate for weatherization.

1. **Cool roofs:** roofs that reflect 60% or more of the solar radiation that impinges on them.
2. **Landscaping:** the most cost-effective shading approach when applied skillfully, but needs time to mature.
3. **Window treatments:** awnings, solar screens, and blinds can reduce the solar radiation reaching the indoors.

See the following sections for more information on shading.

- [“Cool Roofs” on page 164](#)
- [“Landscaping” on page 165](#)
- [“Solar Screens” on page 253](#)
- [“Solar Window Films” on page 253](#)
- [“Cool Roofs for Mobile Homes” on page 532](#)

### 3.9 SWS ALIGNMENT

Field Guide Topic	SWS Detail
3.2: Air Sealing Safety - Pg. 96	3.0 Air Sealing
3.3: Air Sealing Materials - Pg. 98	3.0101 General Air Sealing 3.0102 Specific Air Sealing
3.5: Insulation Material Characteristics - Pg. 107	4.0 Insulation
3.7: Insulation Safety and Durability - Pg. 118	4.0 Insulation

<b>Field Guide Topic</b>	<b>SWS Detail</b>
3.8: Shading Materials and Methods - Pg. 120	5.0401.1 Indigenous Shading 5.0402.1 Reflective Roof Coatings



## CHAPTER 4: ATTICS AND ROOFS

This chapter discusses air sealing and insulating attics and roofs. Whether the thermal boundary is at the attic floor or the roof, the air barrier and the insulation should be adjacent to one another and continuous at that location.

### 4.1 AIR-SEALING ATTICS AND ROOFS

*SWS Detail: 3.0101.1 Air Sealing Holes; 3.0102.2 Sealing High-Temperature Devices; 3.0102.1 Sealing Non-Insulation Contact (IC) Recessed Light; 3.0102.9 Sealing Dropped Soffits/Bulkheads; 3.0102.10 Sealing Dropped Ceilings*

Air sealing attics and roofs may be the most important and cost effective weatherization measure and one of the most challenging. The attic or roof is a prominent location for air-leakage and moisture damage. Building fires tend to spread through large air leaks in the attic. Air-sealing can prevent these problems.

*See “Material and Sealant Specs” on page 98.*

#### 4.1.1 Sealing Vertical Chases and Chimneys

*SWS Detail: 3.0101.1 Air Sealing Holes; 3.0102.2 Sealing High-Temperature Devices*

Observe the following specifications when sealing vertical chases.

- ✓ Inspect the chase for damage and pest infestation. Repair and disinfect as necessary.
- ✓ Span the entire opening with a rigid material.
- ✓ Use structural supports like 2-by-4s or stronger lumber for spans more than 24 inches where the assembly may bear a person’s weight.

- ✓ Seal joints and seams at the perimeter with a compatible sealant.
- ✓ Install only noncombustible materials and sealants with an ASTM E136 listing in contact with any device producing 200 degrees F or more: for example —chimneys, light fixtures, vents, and flues.

*See “Air-Barrier Materials” on page 99.*

## Sealing around Manufactured Chimneys

Several types of manufactured chimneys are common in residential buildings. We explain these in *“Manufactured Chimneys” on page 326*. Observe the required clearances listed in *“Clearances to Combustibles for Common Chimneys” on page 326*.

Install the chimney’s air seal with an insulation shield if you’ll retrofit insulation after air sealing.

- ✓ Remove existing insulation from around the manufactured chimney.
- ✓ Cut light gauge aluminum or galvanized steel in two pieces with half-circle holes for the chimney that create small caulk-able cracks.
- ✓ Bed the metal in sealant and staple, nail, or screw the metal in place.
- ✓ Caulk around the junction of the chimney and the metal and air seal with non-combustible caulk labeled ASTM E136.
- ✓ Cut and assemble a metal insulation shield that creates a 3-inch space between the shield and chimney and extends above the planned level of the retrofit insulation.
- ✓ Move the existing insulation that you removed back into place around the insulation shield before installing the retrofit insulation.

*See also “Air Sealing and Fire Containment” on page 97.*



**Sealing manufactured chimneys:** When installing retrofit insulation in addition to air sealing, install a shield on top of the air seal that extends above the level of the new insulation.



**Video: Air sealing and shielding metal chimneys—** Method and materials used to safely shield and air seal a metal chimney.

## Sealing around Masonry Chimneys

Leaks around fireplace chimneys are often severe air leaks. Use this procedure to seal air leaks through the chimney chase.

- ✓ Cut sheet metal to fit the gap that borders the chimney with overlaps connecting to nearby attic framing lumber.
- ✓ Bed the sheet metal air seal in sealant, and then fasten the sheet metal to the attic framing with staples, nails, or screws.

- ✓ Seal the metal patch to chimney or flue with a non-combustible sealant labeled ASTM E136.
- ✓ Seal other gaps between the attic and the chimney chase.
- ✓ For large chimney chases, cover the chase opening with structural material such as plywood. Maintain clearances between the structural seal and the metal or masonry chimney as listed in *“Clearances to Combustibles for Common Chimneys”* on page 326.

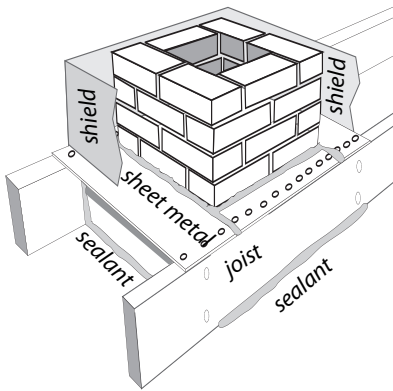

**Sealing around chimneys:** Chimneys require both an air seal and a shield if retrofit insulation is installed with air sealing.

## 4.1.2 Air Sealing Recessed Lights

*SWS Details: 3.0102.1 Sealing Non-Insulation Contact (IC) Recessed Light; 3.0102.2 Sealing High-Temperature Devices*

The most common type of recessed light fixture is the round can. However all recessed light fixtures are potential air leaks and air-leakage conduits. Many recessed light fixtures have safety switches that turn them off at around 150° F. Too much insulation covering the fixture or foam insulation could cause the safety switch to cycle.

## Types of Recessed Can Lights

There are three kinds of recessed can lights found in buildings with regard to their need for insulation shielding. (IC means insulation contact. AT means airtight.)

1. Older cans that aren't rated for contact with insulation, known as non-IC-rated cans.
2. IC-rated cans that may be covered with fibrous insulation but not foam insulation.
3. ICAT-rated cans that are airtight in addition to being rated for insulation contact. The tightest ICAT fixtures have pin-based CFLs or LEDs.

## Options for Sealing Non-IC-Rated Fixtures

Consider these three options for air sealing recessed can lights. You can enclose the existing fixture, replace it with an ICAT recessed fixture, or retrofit it with an LED retrofit kit.

1. Build a Class I fire-resistant enclosure over the non-IC-rated fixture leaving at least 3 inches clearance from insulation on all sides and to the lid of the enclosure. Seal this enclosure to surrounding materials with foam to create an airtight assembly. The top of this fire-resistant enclosure must have an R-value of 0.5 or less. Don't cover the top of the enclosure with insulation.
2. Replace the recessed fixture with a new ICAT fixture, and carefully seal around this airtight fixture.
3. Install an airtight LED-retrofit assembly in the existing can. This option assures that the light is energy-efficient and low heat because you replace the existing incandescent lamp holder with a cooler LED retrofit assembly.

If the non-IC rated fixture remains, replace the incandescent lamp with a compact fluorescent lamp (CFLs) or LED lamp,

which operates cool and minimizes the fire hazard associated with these fixtures.

**Caution:** Don't cover IC-rated or airtight IC-rated fixtures with spray foam. The foam's high R-value and continuous contact could overheat the fixture.

*See also "Safety Preparations for Attic Insulation" on page 141.*

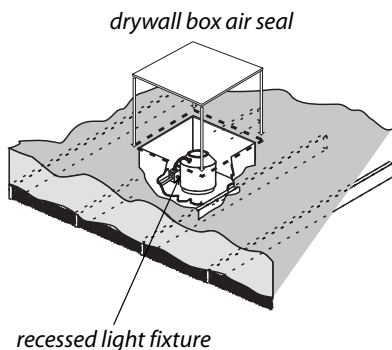

**Air seal and shield for non-IC can:** This drywall box is an insulation shield and air seal, but allows the fixture some air circulation for cooling.



**Low-air-leakage trim retrofit:** These kits employ a standard Edison base. Install a CFL or an LED in the base for maximum energy savings.

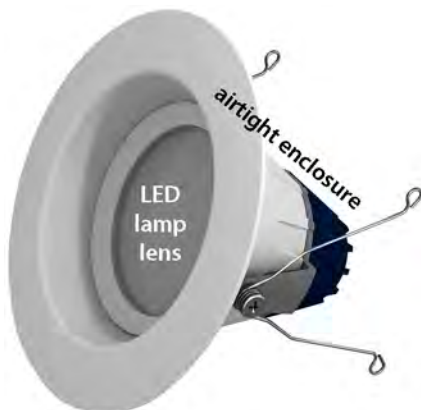

**Airtight LED retrofit for can lights:** These retrofit fixtures provide a low-wattage LED with a low-air-leakage enclosure that inserts into the existing can light.

### 4.1.3 Sealing Stairways and Access Doors

*SWS Details: 3.0102.11 Sealing Roof/Wall Connections; 3.0103.2 Exterior Roof Access Panels and Hatches; 3.0103.1 Access Doors and Hatches*

There are a variety of stairways, hatches, and access doors that provide access from buildings to an unconditioned attics.

The following components of these locations may need air sealing and insulation depending on whether they are at the thermal boundary.

- The risers and treads of the stairways
- The surrounding triangular walls
- Vertical or horizontal doors or hatches
- The framing and sheeting surrounding the doors or hatches
- Sloping ceilings above the stairways

Consider the following air-sealing procedures.

- ✓ Study the geometry of the stairway and decide where to establish the air barrier and install the insulation.
- ✓ Weatherstrip around doors and hatches if the door or hatch is at the thermal boundary.
- ✓ Air seal and densepack the walls and underneath stair-stringers if the stairs define the thermal boundary.
- ✓ Seal gaps between the door frame and the framing with one-part foam, two-part foam, or caulking.
- ✓ If attic insulation is or will be above the level of the attic-access hole, build a dam that extends above the top of the insulation around attic access hatch. Build the dam strong enough to support the weight of anyone entering the attic. Air seal this dam to the surrounding structure of the attic access hatch.

- ✓ With existing insulation dams, clear existing fibrous insulation from around dam around the hatch framing. Spray two-part foam around the perimeter to reduce heat loss through the hatch framing.

See also "Walk-Up Stairways and Doors" on page 161.

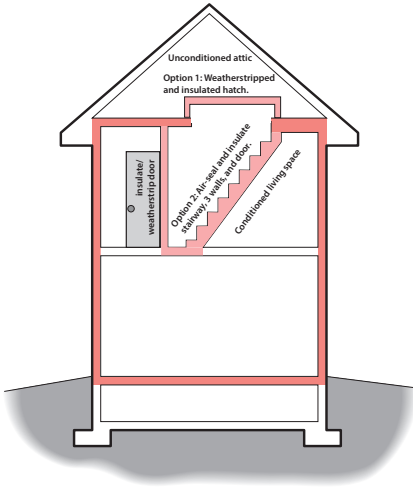

#### Stairways at the thermal

**boundary:** The stairway may be within the thermal boundary or outside it. Only walls, ceilings, doors, and hatches at the thermal boundary require thorough air sealing. The door as shown is open.

### 4.1.4 Sealing Porch Roof Structures

Porch roofs on older homes were often built at the framing stage or before the water resistive barrier (WRB) and siding were installed. The porch's roof sheathing, roofing, and tongue-and-groove ceiling aren't air barriers. The loosely fitting wall sheathing or unsheathed wall allows air into the wall cavities where it migrates into the conditioned space or convects heat into or out of the building.

Consider these options for air sealing leaks through a porch roof.

- Remove part of the porch ceiling and install a rigid air barrier or cover the area with closed-cell spray foam.
- Dense-pack the porch-roof cavity to reduce the airflow through the porch roof and wall cavities.



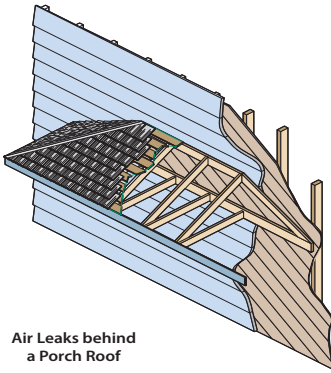

Air Leaks behind  
a Porch Roof

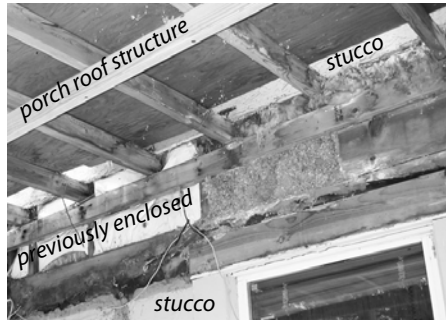

**Porch air leakage:** Porch roof cavities often allow substantial air leakage because of numerous joints, and because there may be no siding or sheathing installed in the wall behind the roof and ceiling.

## 4.1.5 Removing Insulation for Attic Air Sealing

### *SWS Detail: 3.0101.1 Air Sealing Holes*

Attic air sealing is essential for successful air sealing jobs. Removing insulation from an attic for the purpose of air sealing may be worth the cost and effort. Batts and blankets can be rolled up, moved out of the way, and re-used. Loose fill insulation can be vacuumed with commercial vacuum machines available from the same suppliers that sell insulation-blowing machines. Many insulation companies own large vacuums for loose-fill insulation.



**Removing attic insulation:** Technicians vacuum and collect existing attic insulation for re-use or disposal because of moisture damage or to allow effective air sealing.

## 4.1.6 Sealing Joist Cavities Under Knee Walls

### *SWS Detail: 3.0101.1 Air Sealing Holes*

Floor joist cavities beneath knee walls allow air from a ventilated attic space to enter the floor cavity between stories. This is a problem of homes with a finished attic, also known as story-and-a-half homes.

Create an air seal between the knee wall and the ceiling of the space below using one of these methods.

- From the attic, install a combination of rigid foam with one-part or two-part foam sealing the perimeter.
- From the attic, stuff a fiberglass batt into the joist space and seal it with spray two-part foam from the attic.
- From the attic, install foam board on the attic side of the knee wall and continue it down to cover the joist space by cutting slots in the foam board for the joists. Seal around the joists and at the ceiling of the space below with spray foam.
- From indoors, cut the flooring back from the wall at the indoors and install the air seal and insulation under the knee wall.

## 4.1.7 Sealing Kitchen or Bathroom Interior Soffits

*SWS Detail: 3.0102.9 Sealing Dropped Soffits/Bulkheads;  
3.0102.11 Sealing Roof/Wall Connections*

Many modern homes have soffits above kitchen cabinets and in bathrooms. Large rectangular passages link the attic with the soffit cavity. At best, the air convects heat into or out of the conditioned space. At worst, attic air infiltrates the conditioned space through openings in the soffit or associated framing.

- ✓ Seal the soffit with plywood or drywall, bedded in sealant and fastened to ceiling joists and soffit framing with screws, nails or staples.
- ✓ Seal the patch's perimeter thoroughly with two-part foam or caulking.

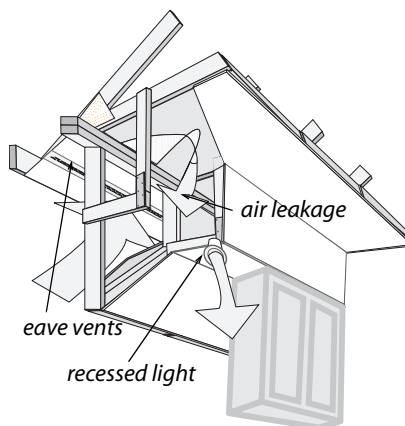

**Kitchen soffits:** The ventilated attic is connected to the soffit and the wall cavity through framing flaws. Any hole in the soffit creates a direct connection between the kitchen and attic. Block off the soffit from the attic with drywall or plywood sealed with two-part spray foam as shown in the photo.

## 4.1.8 Sealing Two-Level Attics

*SWS Detail: 3.0102.11 Sealing Roof/Wall Connections; 4.0201 Accessible Walls*

Split-level and tri-level homes have a particular air leakage problem related to the walls and stairways dividing the homes' levels.

- ✓ Seal wall cavities below the ceiling joists from the attic with a rigid material fastened to studs and wall material.
- ✓ Or insert folded fiberglass batt into the wall cavity and spray with at least one inch of two-part foam to create a rigid air seal.
- ✓ Dense-pack the transitional wall or insulate it with fiberglass batts. Either way install an air barrier on the attic side of the wall.
- ✓ Seal all penetrations between both attics and conditioned areas.

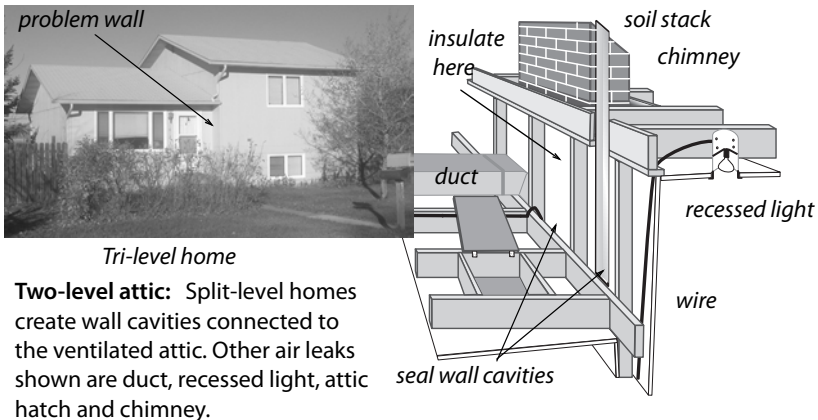

**Two-level attic:** Split-level homes create wall cavities connected to the ventilated attic. Other air leaks shown are duct, recessed light, attic hatch and chimney.

## 4.1.9 Sealing Dropped Ceilings

*SWS Detail: 3.0102.10 Sealing Dropped Ceilings*

## Suspended T-bar Ceilings

Suspended ceilings are seldom airtight, especially the T-bar variety. T-bar ceilings and other non-structural suspended ceilings aren't usually a good location for an air barrier.

- The suspended-ceiling panels aren't air barriers.
- Installers hung the ceiling room by room.
- Technicians may need access to the crawl space above the suspended ceiling in multiple locations to work on utilities installed above the ceiling.

Take down some panels of a suspended ceiling to inspect the suspended ceiling or gain access from above. If there is a plaster ceiling above a non-structural suspended ceiling, and it is weak and failing, consider these options.

- ✓ If you install insulation on top of existing insulation above the failing ceiling, make the original ceiling the air barrier.
- ✓ Reinforce the existing plaster with screws and plaster washers.
- ✓ Screw drywall over areas of missing plaster.
- ✓ Seal the ceiling's joints and perimeter with liquid foam or other sealant.

An insulated roof deck (steel/concrete) above a non-structural suspended ceiling may be the only practical place to establish an air barrier. The perimeter walls and the wall-roof junction may be leaky and uninsulated.

- ✓ Air seal the roof-wall junction with SPF or other liquid-applied air sealant.
- ✓ Air seal the perimeter walls above the suspended ceiling and insulate them if they are exterior walls.
- ✓ Insulate the walls if necessary to complete the insulation and air barrier at the thermal boundary.

## Strong Dropped Ceilings

Ceilings suspended using lumber or steel studs, on the other hand, may be structural enough for a lightweight person to walk on (very carefully).

- ✓ Seal and insulate the walls between the dropped ceiling and upper ceiling.
- ✓ Seal the ceiling joints, penetrations, and perimeter with spray foam or other sealant.
- ✓ Either insulate above the dropped ceiling or above the original ceiling.

If you decide to insulate above the original ceiling, consider making the original ceiling the air barrier unless there is too much damage or that task is too difficult.

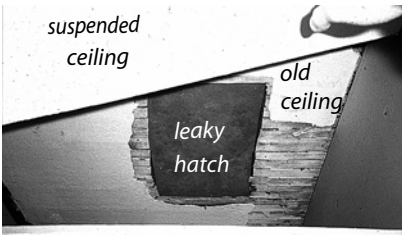

**Sealing existing upper ceilings:** With a non-structural suspended ceiling and a damaged plaster ceiling above, seal the plaster ceiling above if it's impractical to air seal the suspended ceiling.

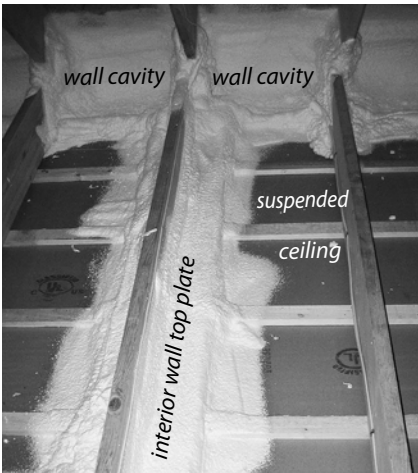

**Sealing structural suspended ceilings:** Two-part foam air seals and insulates an interior wall top plate and the wall cavity between the ceiling and roof deck.



**Sealing the roof deck:** Seal the roof wall junction with spray foam. Insulate the walls above the suspended ceiling. Insulate the roof deck if there's no insulation on top of the roof deck.

## 4.2 INSULATING ATTICS AND ROOFS

*SWS Detail: 4.0101 Exterior Roof Insulation; 4.0102 Interior Roof Insulation; 4.0103 Attic Floors - Unconditioned Attics; 4.0188.2 Unconditioned Attic Ventilation*

Attic and roof insulation are two of the most cost-effective energy-conservation measures.

An attic is a space under a roof where a person can walk or crawl. Buildings with flat ceilings and sloping roofs are usually insulated above the ceiling and this is attic insulation.

Buildings with sloping ceilings and flat roofs are usually insulated inside the roof cavity. Roof cavities may not be accessible for walking or crawling.

A majority of buildings have fibrous insulation in their attics or roof cavities. Fibrous insulation is the most economical insulation for attics and roof cavities. Attics and roof cavities need ventilation for drying, cooling, and to prevent ice dams. *See “Fibrous Insulation Materials” on page 107.*

#### General Insulation Specifications: **Important**

- ✓ Select fibrous insulation with a flame-spread/smoke developed of 25/450.
- ✓ Select foam insulation with a flame-spread/smoke-developed of 75/450.
- ✓ Separate all fibrous and foam insulation from living spaces or storage spaces with a thermal barrier or an ignition barrier as specified by applicable building code and the authority having jurisdiction (AHJ).
- ✓ Post an insulation certificate, with insulation type and number of bags installed, installed thickness, coverage area, and insulation R-value at the attic entrance. *See “Insulation Receipt or Certificate” on page 106.*



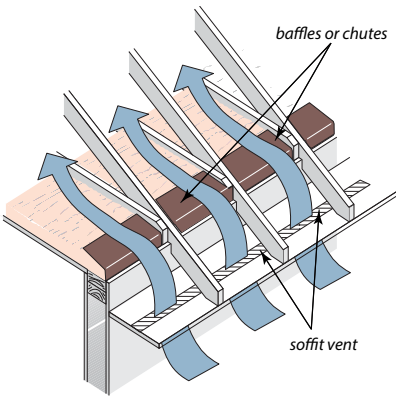

**Ventilation pathways:** Install baffles or chutes in every rafter bay where soffit or eave venting exists.

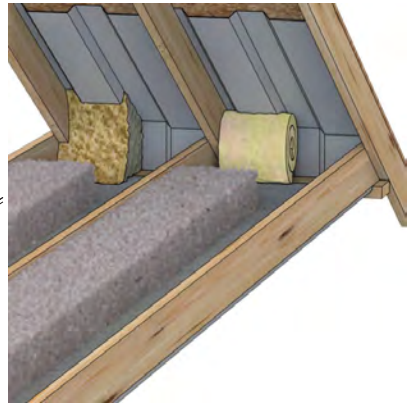

**Insulation at the eaves:** Stuff fibrous insulation into the eave area to maximize R-value. Use spray foam to air seal this area.

## 4.2.1 Preparing for Attic Insulation

*SWS Detail: 4.0103 Attic Floors - Unconditioned Attics; 3.0103.1 Access Doors and Hatches*

Take these preparatory steps before insulating the attic.

- ✓ Repair roof leaks, remove other moisture sources, and repair other attic-related moisture problems before insulating attic.
- ✓ Remove hazardous materials, contaminated insulation, and debris from the attic, employing hazmat professionals if necessary.
- ✓ Shield or replace unshielded high-temperature devices — non-IC rated recessed lights, chimneys, flues, vents, for example — unless they are zero clearance devices. *See “Safety Preparations for Attic Insulation” on page 141.*

- ✓ Vent all kitchen and bath fans outdoors through appropriate roof fittings or side wall fittings. See *“Fan and Duct Specifications”* on page 419.
- ✓ Seal the perimeter of the eave area, install baffles or chutes using mechanical fasteners such as staples or screws, and install insulation against the baffle maximize the R-value at the attic’s perimeter. Evaluate attic ventilation.
- ✓ Before insulating the attic, seal air leaks and bypasses as described in *“Air-Sealing Attics and Roofs”* on page 123
- ✓ Verify attic air-tightness as described in *“Simple Zone Pressure Testing”* on page 560.
- ✓ Install an attic access hatch if none is present, preferably at a large gable vent on the home’s exterior. An interior attic hatch should be at least 22 inches square if possible. Insulate the hatch with rigid foam board to the maximum practical R-value. The roof’s height above the hatch may limit the thickness of insulation that you can attach to the back of the hatch door.
- ✓ Build an insulation dam around the attic access hatch two inches above the height of the insulation. Build the dam with rigid materials like plywood or oriented-strand board so that the dam supports the weight of a person entering or leaving the attic.



**Video: Attic Insulation Preparation**— All of the steps necessary to inspect and prepare an attic for insulation.

**Insulated attic hatch:** Building a dam prevents loose-fill insulation from falling down the hatchway. Foam insulation prevents the access hatch from being a thermal weakness. Install foam to achieve attic-insulation R-value of R-38. Foam can be glued together in layers.

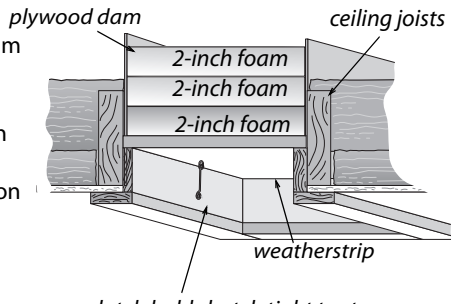

## 4.2.2 Safety Preparations for Attic Insulation

*SWS Detail: Section 4 Insulation; 4.0103 Attic Floors - Unconditioned Attics; 2.0301.1 Junctions/Splices Enclosed; 2.0301.2 Knob and Tube Wiring - Isolation*

Before insulating the attic, remove electrical hazards and protect heat-producing fixtures, such as recessed light fixtures and chimneys, by installing shields. Without shields, the light fixture or chimney might ignite the insulation. Or, the insulation might cause a light fixture or chimney to become hot enough to ignite something else.

The shielding enclosure must often serve as the air seal for the chimney or light fixture.

### Protecting Electrical Wires and Enclosures

Verify that all wire splices are enclosed in UL-listed electrical enclosures with UL listed covers. All enclosures must have UL-listed covers.

See [“Electrical Safety” on page 53](#) and [“Constructing Shielding for Knob-and-Tube Wiring” on page 56](#).

### Protecting Recessed Light Fixtures

There are three different types of recessed light fixtures and light-fan fixtures. (IC = insulation contact)

1. Non-IC-rated fixtures that must not touch insulation.

2. Type IC-rated fixtures that may be covered with fibrous insulation.
3. Type IC-AT, which are reasonably airtight (AT) and safe for contact by fibrous insulation.

Consider these options when preparing recessed light fixtures for attic insulation.

- Remove the recessed light fixture and replace it with a surface-mount fixture.
- Replace non-IC-rated fixtures with airtight IC-rated fixtures (IC-AT). You can cover these IC-AT fixtures with fibrous insulation after sealing the gap between the fixture and the surrounding materials.
- If the existing fixture is rated IC, you can seal the fixture's enclosure to the ceiling with caulk and cover the fixture with fibrous insulation. Or you can shield the fixture with an enclosure, seal the enclosure to the ceiling with foam, and then cover the enclosure with insulation.
- Shield all existing non-IC-rated fixtures with airtight enclosures that provide 3-inch clearance above the level of the retrofitted insulation. Seal the enclosure to the ceiling with foam, and then surround the enclosure with insulation, but don't insulate over its top.
- In cavities that are sheathed on both sides, either shield non-IC recessed lights or replace them before dense-packing the cavities.

**Caution:** Spray foam air sealant must not cover or surround recessed light fixtures or any other heat-producing devices.

### Enclosing the Non-IC Fixture that Remains

If an existing older recessed fixture that isn't labeled IC must remain in place, do these steps.

### Recessed light fixtures:

Cover recessed light fixtures with fire-resistant drywall or sheet-metal enclosures to reduce air leakage to allow installers to safely insulate around the box.

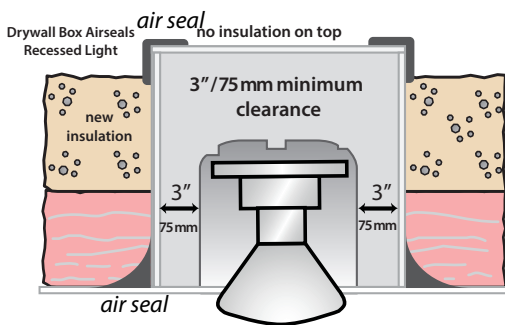

- ✓ Build a Class I fire-resistant enclosure over the non-IC-rated fixture leaving at least 3 inches clearance from insulation on all sides and to the lid of the enclosure. The top of this fire-resistant enclosure must have an R-value of 0.5 or less and extend 4 inches above the level of the new insulation.
- ✓ Notch the shields around wires.
- ✓ Seal the enclosure to the ceiling with foam or caulk.
- ✓ Don't cover the top of the enclosure with insulation.

### Protecting Chimneys

The requirements for protecting chimneys from contact with insulation vary widely from one building department to another. We know of three common approaches to insulating around chimneys, which are listed here beginning with the most restrictive.

1. air seal around the chimney using non-combustible material like 26 gauge galvanized steel. Seal the steel to the chimney with a high-temperature sealant.
2. After air sealing gaps, install non-combustible insulation shields around masonry chimneys and manufactured metal chimneys to keep insulation at least 3 inches away from these chimneys.

3. A clearance smaller than 3 inches may be allowed if the attic insulation is non-combustible or if the specifications of the vent material allow a clearance less than 3 inches. For example: type B gas vent has a typical minimum clearance of 1 inch and all-fuel chimneys have a typical minimum clearance of 2 inches.
4. If the insulation is non-combustible, such as blown fiberglass or rock wool, no clearance between insulation and manufactured or masonry chimneys is necessary if this option is permitted by local building officials.

**Air-sealed chimney with metal shield:**  
Metal flashing bridges the gap between the chimney and the framing. A metal shield keeps the insulation 3 inches away from the chimney.

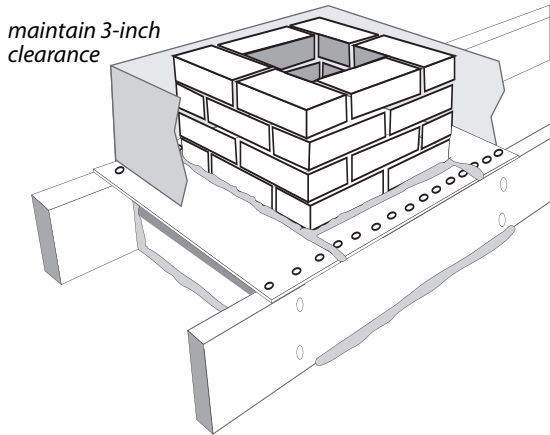

## Electrical Junction Boxes

Observe these specifications during attic-insulation preparation.

1. Install covers on all electrical junction boxes that lack covers.
2. Use caulk or two-part foam to air seal electrical boxes that penetrate the ceiling (for light fixtures and fans), before blowing fibrous insulation over the boxes.
3. Flag the electrical boxes so that an electrician can find the boxes for future electrical work.

## Knob-and-Tube Wiring

If knob-and-tube wiring is present in the attic, consider decommissioning knob-and-tube wiring prior to installing insulation or shielding it. Alternatively, maintain a minimum of 3" clearance between the attic insulation and the knob-and-tube wiring. See [“Decommissioning Knob-and-Tube Wiring” on page 55](#) or [“Constructing Shielding for Knob-and-Tube Wiring” on page 56](#)

## Isolating Fibrous Insulation from Occupants

If you install fibrous insulation in open cavities within living spaces, cover the insulation to protect occupants from breathing fibers. A thermal barrier, like drywall, may be necessary to establish or maintain an acceptable fire rating of the assembly.

### 4.2.3 Blowing Attic Insulation

*SWS Detail: 4.0103.2 Accessible Attic - Loose Fill Installation; 4.0103.4 Accessible Attic - Loose Fill Over Existing Insulation; 4.0103.6 Accessible Attic - Dense Pack Insulation; 4.0103.8 Loose Fill to Capacity; 4.0188.2 Unconditioned Attic Ventilation*

Install attic insulation to a cost-effective R-value, depending upon existing insulation level and climatic region. Air seal attics before installing attic insulation. Air sealing may require removing existing insulation and debris that obstruct air sealing. See [“Removing Insulation for Attic Air Sealing” on page 131](#).

Blown insulation is usually better than batt insulation because blown insulation forms a seamless blanket. Blown fibrous attic insulation settles: cellulose settles 10% to 20% and fiberglass settles 3% to 10%. Blowing attic insulation at the highest achievable density helps minimize both settling and air circulation within the blown insulation.

Observe these specifications when blowing loose-fill attic insulation.

- ✓ Calculate how many bags of insulation are needed to achieve the R-value specified on the work order from the table on the bag's label.
- ✓ Install insulation depth rulers: one for every 300 square feet.
- ✓ Maintain a high density by moving as much insulation as possible through the hose with the available air pressure. The more the insulation is packed together in the blowing hose, the greater is the insulation's installed density.
- ✓ Fill the edges of the attic first, near the eaves or gable end, then fill the center.
- ✓ When filling a tight eaves space, push the hose out to the edge of the ceiling. Allow the insulation to fill and pack against the chute or baffle.
- ✓ Install insulation to a consistent depth. Level the insulation with a stick if necessary.
- ✓ See *"Insulation Receipt or Certificate"* on page 106.

**Blown-in attic insulation:** Blown insulation is more continuous than batts and produces better coverage. Insulation should be blown at a high density to minimize settling and air convection.

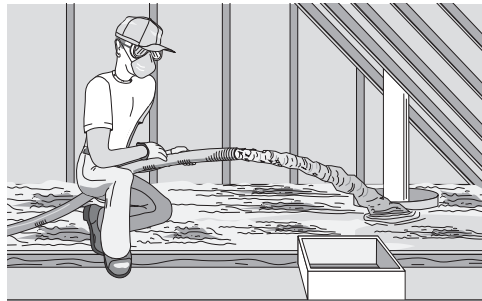

#### 4.2.4 Closed-Cavity Attic Floors

*SWS Detail: 4.0103.8 Loose Fill to Capacity; 4.0103.6 Accessible Attic - Dense Pack Insulation*



The ceiling joists in the attic are often covered by a wood floor for storage. You may have to remove some floor boards or drill the floor sheathing to install dense-packed insulation.



**Finished attic floor:** Find the large air leaks underneath the flooring and seal them before insulating the space between the joists.

- ✓ Check for live knob-and-tube wiring in the cavity, and act to decommission it or protect it from burial in insulation. *See “Knob-and-Tube Wiring” on page 145.*
- ✓ Protect recessed light fixtures and other heat-producing devices in the floor cavity. *See “Protecting Recessed Light Fixtures” on page 141.*
- ✓ Thoroughly seal the floor cavity’s air leaks before blowing insulation.
- ✓ Then dense-pack fiberglass or cellulose insulation into the spaces between the ceiling joists.
- ✓ *See “Insulation Receipt or Certificate” on page 106.*

## 4.2.5 Insulating Closed Roof Cavities

*SWS Detail: 4.0103.7 Accessible Pitched/Vaulted/Cathedralized Ceilings - Loose Fill Over; 4.0103.6 Accessible Attic - Dense Pack Insulation; 4.0102.3 Inaccessible Ceilings - Dense Pack*

Many existing homes have cathedral ceilings or flat roofs that are partially filled with fibrous insulation. These roofs are often unventilated or ineffectively ventilated. The insulation job may

include repair of the roof deck and installation of foam insulation over the roof deck. The IRC building code requires one of these two approaches to insulate a roof cavity.

1. Verify or provide a continuous ventilated space of at least one inch between the roof insulation and the roof sheathing by providing both soffit and ridge ventilation.
2. If no roof ventilation, then install foam roof insulation in addition to filling the cavity with insulation. Foam-insulation R-value must be between R-5 and R-35 depending on climate as specified by the IRC.

### Ventilated Closed Roof Cavities

To prepare for roof-cavity insulation, without existing baffles and with a ventilated space above the insulation, use this procedure.

- ✓ Remove either the roofing and sheathing or the interior ceiling to gain full access to the cavity.
- ✓ Remove recessed light fixtures and replace them with surface-mounted light fixtures. Carefully patch and air seal the openings.
- ✓ Install fiberglass or foam insulation to meet the IECC regional minimum roof-assembly R-value requirements.
- ✓ Install openings into the ventilation channel above the insulation totaling  $\frac{1}{150}$  of the roof area. If the ceiling has a Class I or II vapor retarder, the requirement is reduced to  $\frac{1}{300}$  of the roof area.
- ✓ In cold climates, install a Class I or II vapor retarder at the ceiling. One option is to paint an oil-based primer over the interior drywall or plaster.
- ✓ Repair roof leaks or install a new water-tight roof. Replace moisture-damaged sheathing as part of the roof replacement.

- ✓ Install an air-barrier ceiling (drywall) if the existing ceiling isn't an adequate air barrier, for example tongue-and-groove paneling.
- ✓ Seal other air leaks with great care, especially at the perimeter and around ridge beams.

## Un-Ventilated Closed Roof Cavities: Decisions

Many homes have cathedral ceilings, vaulted ceilings, or flat roofs that are partially or completely filled with insulation and would require major building surgery to install code-compliant roof ventilation or rooftop foam board during retrofit cavity insulation.

Dense-packing the cavities prevents most convection and moist-air infiltration, which are leading causes of moisture problems in roof cavities.

Insulators have dense-packed many cathedral roof cavities with fiberglass insulation without ventilation or foam rooftop insulation. Some experts believe that this method is acceptable. However, this method isn't a code-compliant one, and it usually requires special approval by the building department when and if the department issues a building permit.

**Important Note:** Dense-packing roof cavities with fiberglass insulation and without ventilation is controversial. The colder the climate, the higher the risk of problems, such as ice damming. However, dense-packing the cavities prevents most convection and moist-air infiltration, which are leading causes of moisture problems in roof cavities. Consult a knowledgeable local engineer before deciding to dense-pack a roof cavity with fiberglass. Don't dense-pack roof cavities with cellulose because of its moisture absorption and its susceptibility to moisture damage.

## Closed Roof Cavities: Preparation

To prepare for dense-packing the roof-cavity, consider the following steps.

- ✓ Reduce or eliminate sources of moisture in the home. [See "Solutions for Moisture Problems" on page 36.](#)
- ✓ Verify that the ceiling has a Class I or II vapor retarder and air barrier on the interior. If not, install a vapor retarder and air barrier.
- ✓ Remove recessed light fixtures and replace them with IC-AT fixtures or surface-mounted fixtures. Carefully patch and air seal the openings if you replace the recessed fixtures with surface-mounted ones.
- ✓ Seal other ceiling air leaks, large and small, with great care.
- ✓ When replacing the roof during roof-cavity insulation, install 1-to-8 inches of rigid high-density foam insulation on top of the roof deck, as required by the IRC. If you replace the roof, dense-pack the existing roof cavity as part of the process.

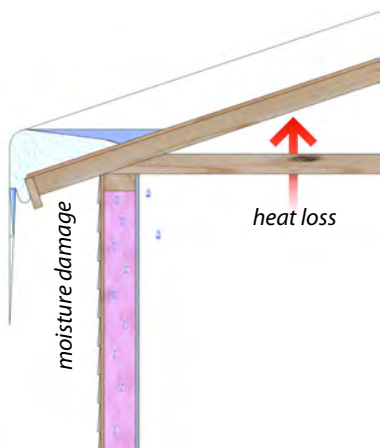

**Ice damming:** When a roof is unventilated, the home's heat loss warms the roof deck melting snow. The water re-freezes at the eaves and causes moisture damage.

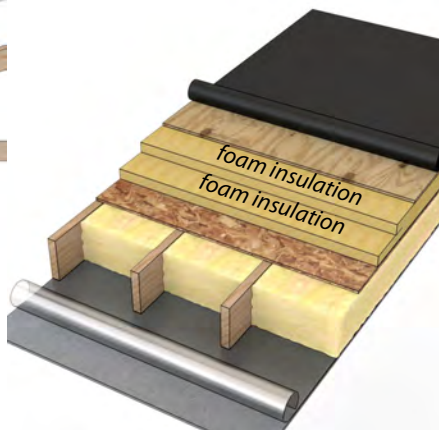

**Rooftop foam insulation:** The IRC code requires foam insulation over the structural sheathing when the roof is unventilated.

## Blowing Insulation into the Closed Roof Cavity

Always use a fill tube when blowing closed roof cavities. Insert the tube into the cavity to within a foot of the end of the cavity. Access the cavity through the eaves, the roof ridge, the roof deck, or the ceiling. Consider one of these procedures.

- Drill holes in the roof deck after removing shingles or ridge roofing.
- Remove the soffit and blow insulation from the eaves. Drill and blow through a drywall ceiling.
- Carefully remove a tongue-and-groove ceiling plank and blow insulation into cavities through this slot.

*See also "Insulating Mobile-Home Roof Cavities" on page 514.*



**Blowing from the eaves:** Some vaulted ceilings can be blown from the eaves and/or the ridge.



**Blowing from the roof deck:** Technicians remove a row of shingles, drill, and blow fiberglass into this vaulted roof cavity.

## 4.2.6 Exterior Rooftop Foam Insulation

*SWS Detail: 4.0101.1 Roof Deck Insulation*

Only install rooftop foam insulation over dense-packed roof cavities. A ventilation space between existing insulation and the new rooftop insulation reduces the roof assembly's R-value. Roofers install exterior foam roof insulation when re-roofing low-sloping roofs after filling the cavities with fibrous insulation.

- ✓ Use high density foam board: 2 pcf for polystyrene or 3 pcf for polyisocyanurate if the roof is flat or low sloping.
- ✓ Flash all external penetrations according to the roofing manufacturer's specifications.
- ✓ Use a cool roofing material such as white rubber or white metal to limit the foam's temperature during intense summer sun and to minimize cooling costs.
- ✓ Contact a design professional to ensure that the roof drains properly after you install foam installation.
- ✓ Provide an insulation certificate, with insulation type and number of bags installed, installed thickness, coverage area, and insulation R-value at the attic entrance. *See "Insulation Receipt or Certificate" on page 106.*

Many foam manufacturers can taper expanded polystyrene foam, providing wedge-shaped pieces to create slope for drainage. *See "Expanded Polystyrene (EPS) Foam Board" on page 116. See "Polyisocyanurate (PIC) Foam Board" on page 117.*

## 4.2.7 Installing Fiberglass Batts in Attics

*SWS Detail: 4.0103.3 Accessible Attic - Batt Insulation Over Existing Insulation; 4.0103.1 Accessible Attic - Batt Installation*

Follow these specifications when installing fiberglass batts in an attic. Fiberglass batts aren't the best insulation for attics because of all their seams.

- ✓ When layering batts, install new layers at right angles to underlying layers if the top of the existing batts are level with or above the ceiling joist or truss bottom chord.
- ✓ Install un-faced fiberglass insulation whenever possible.
- ✓ If you must install faced batts, install them with the facing toward the heated space. Never install faced insulation over existing insulation.
- ✓ Cut batts carefully to ensure a tight fit against the ceiling joists and other framing.

## 4.2.8 Roof Deck Underside /Cathedralized Attics

### *SWS Details: 4.0103.6 Accessible Attic - Dense Pack Insulation*

A cathedralized attic has insulation attached to the bottom of the roof deck and is also called a hot roof if it isn't ventilated. Choose to insulate the bottom of the roof deck instead of insulating the ceiling when the building owner wants to use the attic or to enclose an attic air handler and leaky ducts within the building's thermal boundary.

### Avoiding Moisture Problems

Insulating the underside of the roof deck presents a risk of moisture problems in the structural sheathing from roof leaks or condensation.

To avoid moisture condensation within the insulation or within the structural sheathing during cold weather.

- For additional protection against moisture, install a low-high roof-vent chute to provide ventilating air directly to the roof deck above the insulation.
- If the insulation job requires a permit, see the IRC and the AHJ for guidance on roof insulation, to prevent condensation and optimize the assembly's thermal resistance.

Provide the client an insulation certificate, with insulation type and number of bags installed, installed thickness, coverage area, and insulation R-value. See *“Insulation Receipt or Certificate” on page 106.*

## Fiberglass Roof-Deck Insulation

Insulating the rafter space with an air-permeable insulation requires an air barrier, vapor retarder, and Class I (or A) fire-rated material at the roof cavity’s lower boundary. Consider these two alternatives.

1. Install the rafter’s depth of fiberglass batts and then a material or combination of materials that constitutes an air barrier, vapor retarder, and Class I fire barrier.
2. Blow dense-packed fiberglass insulation between the roof deck using a rigid or flexible insulation restraint.

### 4.2.9 Vaulted Attics

*SWS Detail: 4.0102.3 Inaccessible Ceilings - Dense Pack; 4.0103.1 Accessible Attic - Batt Installation; 4.0103.2 Accessible Attic - Loose Fill Installation; 4.0103.3 Accessible Attic - Batt Insulation Over Existing Insulation; 4.0103.8 Loose Fill to Capacity*

A vaulted attic is framed with a special truss that creates a sloping roof and a sloping ceiling. Access to the cavity varies from difficult to impossible.

Install insulation from either the top of the roof deck or through the ceiling. Insulation, installed at the ceiling, must have some stability to prevent gravity from pulling it downhill or wind from piling it, leaving some areas under-insulated. Damp spray fibrous insulation may serve this purpose.

Consider the following options to insulating uninsulated or partially insulated vaulted attics.



1. Insulate the ceiling with fiberglass batts. Install the batts parallel to the framing if the top of existing insulation is below the framing. Install the batts perpendicular to the framing if the top of the existing insulation is above the framing.
2. Insulate the bottom of the roof deck, as described previously for a cathedralized attic, if you remove the ceiling.
3. Insulate the ceiling with sprayed foam, damp-spray fibrous insulation, or batts from the roof with the roof sheathing removed.
4. Fill the cavity to approximately 100% with loosely blown fiberglass from indoors or through the roof. Maintain the existing vents and hope that settling or under-filling provides room for ventilation.
5. Preserve or install openings into the ventilation space above the insulation totaling  $\frac{1}{150}$  of the roof area. If the ceiling has a vapor retarder the requirement is  $\frac{1}{300}$  of the roof area.
6. Post a dated receipt as described in *“Insulation Receipt or Certificate” on page 106*.

#### 4.2.10 Finished Knee-Wall Attics

*SWS Detail: 4.0104 Attic Knee Walls; 4.0104.1 Knee Wall - Dense Packing; 4.0104.2 Knee Wall - Batt Insulation; 4.0104.3 Knee Wall - Existing Batt Insulation Repair; 4.0104.4 Knee Wall - Rigid Insulation*

The finished attics of story-and-a-half homes or Cape-Cod homes require special procedures when installing insulation. They often include five separate sections that require different air-sealing and insulating methods. Seal air leaks in all these assemblies before insulating them. If necessary, remove the planking and insulation from the side-attic floor to expose the air leaks.

Use these specifications to prepare for insulating finished attics.

- ✓ Seal large air leaks between conditioned and non-conditioned spaces.
- ✓ Inspect the structure to confirm that it has the strength to support the weight of the insulation.
- ✓ Insulate access hatches to the approximate R-value of the assembly through which it is located.
- ✓ Select fibrous insulation with a flame-spread/smoke developed of 25/450. Select foam insulation with a flame-spread/smoke developed of 75/450.

**Attic floor and knee wall:**  
Establish an air barrier at the attic floor and knee wall if you insulate these assemblies.

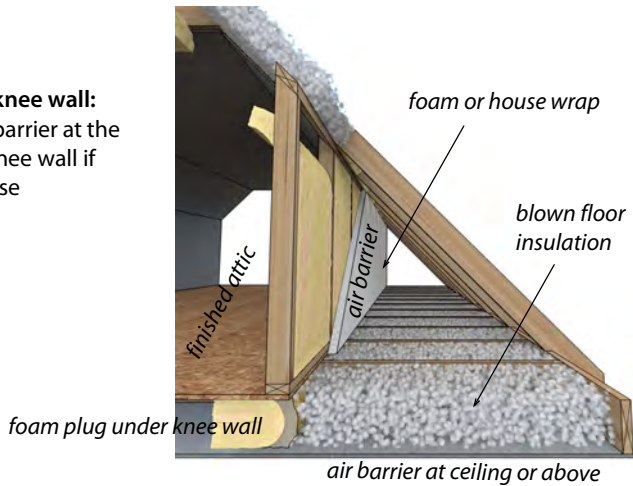

## Attic Floor

There are a number of options for insulating the attic floor of a finished attic with knee walls. By attic floor, we mean the ceiling of the living space below with its ceiling joists and any floor sheeting installed over the joists for a storage platform.

Choose among these options.

- Install blown fibrous insulation over the ceiling, which should be an air barrier.
- Install blown fibrous insulation over existing insulation.

- Install fiberglass batts over the ceiling, which should be an air barrier.
- Install fiberglass batts over the existing insulation.

Whichever of these options that you choose, do the necessary air sealing to the attic floor before installing insulation. Also observe the preparations and safety precautions discussed in [“Preparing for Attic Insulation” on page 139](#) and [“Safety Preparations for Attic Insulation” on page 141](#).

### Exterior Walls of Finished Attic

Insulate these walls as described in [“Retrofit Closed-Cavity Wall Insulation” on page 183](#) or [“Open-Cavity Wall Insulation” on page 195](#).

### Collar-Beam Attic

Insulate this type of half-story attic as described in [“Blowing Attic Insulation” on page 145](#).

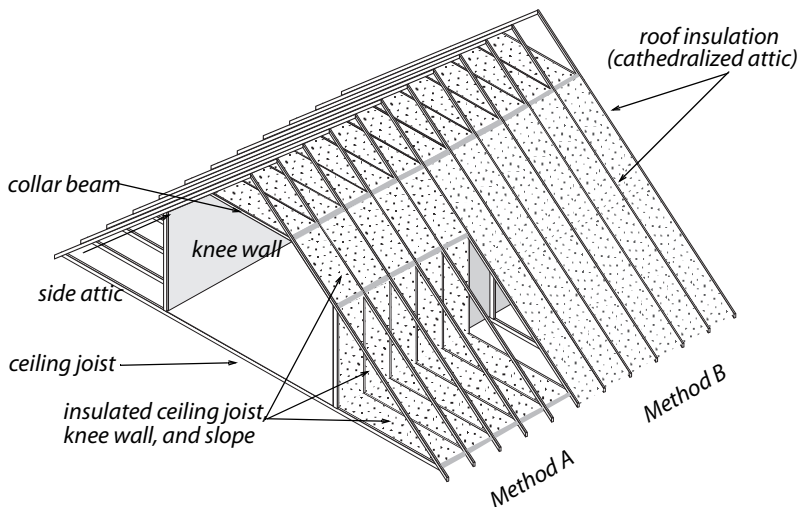

**Finished attic:** This illustration depicts two approaches to insulating a finished attic. Either A) insulate the knee wall and side attic floor, or B) insulate the roof deck.

## Sloped Roof

Insulate sloped roof with densepack fiberglass insulation. Install plugs of fiberglass batt, or other vapor permeable material, at the ends of this cavity to contain the blown insulation while allowing it to breathe.

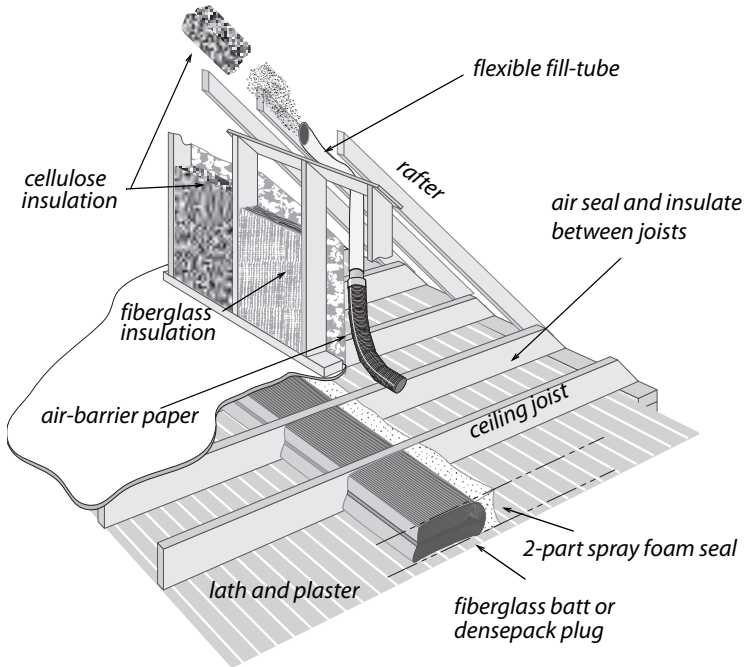

**Finished attic best practices:** Air sealing and insulation combine to dramatically reduce heat transmission and air leakage in homes with finished attics.

### 4.2.11 Knee-Wall Insulation

*SWS Detail: 4.0104 Attic Knee Walls; 4.0104.1 Knee Wall - Dense Packing; 4.0104.2 Knee Wall - Batt Insulation; 4.0104.3 Knee Wall - Existing Batt Insulation Repair; 4.0104.4 Knee Wall - Rigid Insulation*

Insulate knee walls using any of these methods.

- Install un-faced fiberglass batts and cover the insulation with house wrap or rigid foam on the attic side. Prefer R-13 or R-15, 3.5-inch fiberglass batts.
- Install the house wrap, rigid foam, or another insulation restrainer first and reinforce it with wood lath. Then blow dense-packed fibrous insulation into the cavity through the insulation restrainer and patch the insulation restrainer with an airtight patch. (Cellulose: 3.5 pcf; fiberglass 2.2 pcf)
- For knee walls without framing, mechanically fasten rigid insulation to the wall's surface and seal the seams.
- Post a dated receipt as described in *“Insulation Receipt or Certificate” on page 106.*

### Preparation for Knee-Wall Insulation

Make whatever repairs and seal air leaks before installing the knee-wall insulation.

- ✓ Seal all large air leaks with structural materials.
- ✓ Seal all joints, penetrations, and other potential air leaks in the cavities with caulk or foam.
- ✓ Before installing caulk or spray foam, clean dust and any other material that might interfere with the spray foam's adhesion.

### Air Sealing and Insulating under the Knee Wall

To seal and insulate under the knee wall, create an airtight and structurally strong seal in the joist spaces under the knee wall. Consider these options.

- Install sealed wood blocking between the floor joists covered with spray foam.
- Insert 2-inch-thick foam sheets and foam their perimeters with one-part or two-part foam.

- Insert a fiberglass batt into the cavity and foam its face with an inch of two-part closed-cell spray foam.

## 4.2.12 Access Doors in Vertical Walls

### *SWS Detail: 3.0103.1 Access Doors and Hatches*

For knee-wall access doors, observe the following.

- ✓ Insulate knee-wall access hatches and collar-beam access hatch to the approximate R-value of the assembly that surrounds them.
- ✓ Weatherstrip the hatch and install a latch or other method to hold the access door closed against the weatherstrip.

**Insulated access door in knee wall:** Achieve an R-value as close to the wall as practical. Weatherstrip the door and install some type of latch.

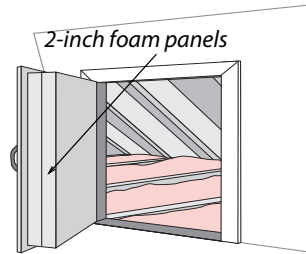

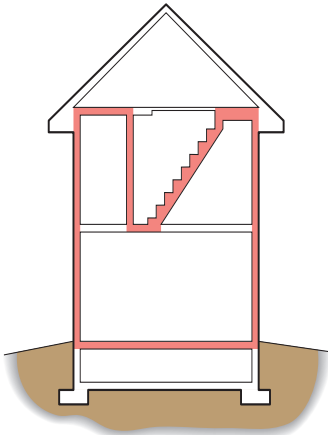

**Insulating and sealing attic stair walls, doors, and stairs:** Insulating and air sealing these is one way of establishing the thermal boundary.

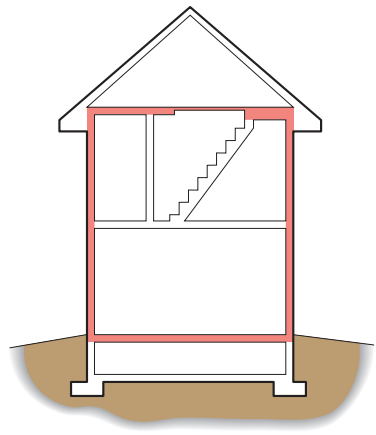

**Insulating and weatherstripping the attic hatch:** Air sealing around the hatch and insulating the hatch is an alternative method.

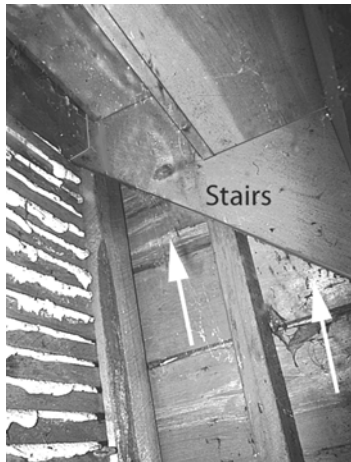

## 4.2.13 Walk-Up Stairways and Doors

*SWS Detail: 3.0103.1 Access Doors and Hatches; 4.0201 Accessible Walls; 3.0202.1 Door Air Sealing*

Think carefully about how to install a continuous insulation blanket and air barrier around or over the top of an attic stair-

way. If you enter the attic by a stairwell and standard vertical door, use these instructions.

- ✓ Blow dense-pack fibrous insulation into walls of the stairwell.
- ✓ Install a threshold or door sweep, and weatherstrip the door.
- ✓ Insulate or replace the door with an insulated door if cost effective.
- ✓ Blow dense-packed insulation into the sloping cavity beneath the stair treads and risers.

You can also establish the thermal boundary at the ceiling level, but this requires a horizontal hatch at the top of the stairs.

When planning to insulate stairwells, investigate barriers such as fire blocking that might prevent insulation from filling cavities you want to fill. Also consider what passageways may lead to areas you don't want to fill, such as closets.

## 4.2.14 Insulating & Sealing Pull-Down Attic Stairways

### *SWS Detail: 3.0103.1 Access Doors and Hatches*

Pull-down attic stairways are sometimes installed above the access hatch. Building a foam-insulated box or buying a manufactured stair-and-hatchway cover are good solutions to insulating and sealing this weak point in the ceiling insulation. Install weatherstripping around the insulated box.

Educate the client on the purpose and operation of stair-and-hatchway cover, and ask them to carefully replace it when they access the attic.



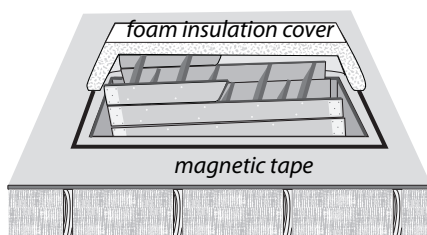

**Manufactured pull-down-stair covers:** Manufacturers provide insulated stair covers for use with walkable attic floors or with dams to be surrounded by fibrous insulation.

## 4.2.15 Parapet Walls

Parapet walls are a continuation of exterior walls that rise above the roof. Parapet walls are often an air-leakage and thermal bridging problem because the insulation and air barrier aren't continuous between the exterior wall and roof.

Inspect the parapet area from both indoors and outdoors and decide how to connect the wall insulation and air barrier with the roof insulation and air barrier. Consider these two alternatives.

1. Install an air barrier and dense-pack the wall cavity of the parapet.
2. Spray foam the parapet to connect the air barrier of the exterior wall with attic or roof's air barrier.

## 4.2.16 Skylights

Skylights are places where the insulation and air barrier may not be continuous. Inspect the insulation and air barrier of the skylight shaft. Install insulation and air seals as necessary to make a continuous insulated and air-sealed assembly as shown in the illustration.

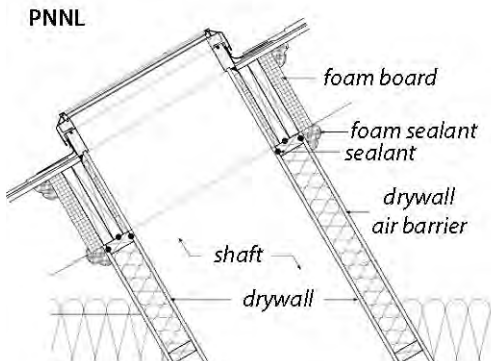

**Insulated and air sealed skylight:** The skylight shaft must be insulated and air sealed from the ceiling to the roof.

## 4.3 COOL ROOFS

### *SWS Detail: 5.0402 Reflective Roofs*

Homes with reflective roof coatings, along with at least R-19 insulation and good attic ventilation, may show two-thirds less solar heat gain than those buildings with darker roofs, little insulation, and poor ventilation.

The best cool roofs must both reflect solar heat and also effectively emit or release solar heat that accumulates in the roof assembly. The concept of emittance informs us that some materials reflect heat well but don't release heat effectively. Their emittance prevents shiny metal materials from being efficient cool-roof materials.

Scientists at Lawrence Berkeley Laboratory created an index for comparing the coolness of roofing materials that combines both reflectance and emittance into a rating more predictive of air-conditioning energy savings. The solar reflectance index (SRI) ranges from a little less than 0 to a little more than 100. High SRI numbers are better than low numbers.

Standard white asphalt shingles have an SRI of only 20 to 25 when new, and that degrades over time due to loss of white granules and dirt deposits. Darker asphalt roofs have SRIs as low

as 1.0 (they absorb almost all the solar heat that strikes them). White metal roofs have good SRIs from 70 to 82.

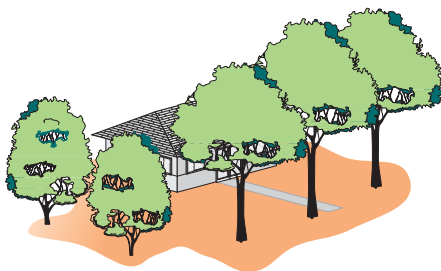

**Roof and window shading:** Tall trees near the south facing walls and broad trees near the east- and west-facing walls are a good shading strategy.

**Reflective roof coatings:** Coatings must be compatible with the existing roof surface and this may require a primer.



Bare galvanized steel and aluminum aren't nearly as cool as white roofing. Those shiny metals reflect solar heat well, but they don't emit heat effectively so they tend to heat up, resulting in SRIs in the 40s for bare galvanized steel and in the 70s for bare aluminum.

Compared to poorly ventilated roofs, good roof ventilation helps to keep attic temperatures lower. But expect less savings from improving attic ventilation compared to cool roofs and other sun-blocking measures, because radiant heat transfer — not air convection — dominates attic heat gain.

*See also "Coating the Roof" on page 533.*

## 4.4 LANDSCAPING

### *SWS Detail: 5.0401.1 Indigenous Shading*

Well-planned landscaping can reduce an unshaded building's summer air-conditioning costs by 15% to 50%. However, poor

tree siting or careless tree selection is common, so consult with landscaping experts during planning and planting.

Studies by the Lawrence Berkeley Laboratory found summer daytime air temperatures 3°F to 6°F lower in neighborhoods with mature tree canopies compared to newly developed areas with no trees.

A tree can produce daily cooling effects similar to five average-sized air conditioners running 20 hours per day. Shading and *evapotranspiration* — the process by which a tree releases water vapor — can reduce air temperatures as much as 9°F compared to unshaded areas.

**Table 4-1: Effectiveness of Cool Roofing Materials**

Roofing type	Reflectance	SRI index
White elastomeric coating (low slope)	.70 to .85	87 to 107
White EPDM rubber membrane (low slope)	.70 to .80	80 to 105
White clay tile	.70	90
White rubber membrane	.70	84
White metal	.60 to .70	82
New aluminum metal	.60	71
New galvanized steel	.60	46
Colored clay tile	.20 to .50	20 to 60
White asphalt shingles	.20 to .30	21 to 40
Colored asphalt shingles	.20	-2 to 22
Black EPDM rubber membrane (low slope)	.06	-1

Higher numbers are better: a high reflectance or high SRI yields low cooling costs. An ENERGY STAR rating (in 2008) requires an SRI of 25 or higher for steep-sloped roofs, and an SRI of 65 or higher for low-slope roofs.

## 4.5 SWS ALIGNMENT

Field Guide Topic	SWS Detail
4.1: Air-Sealing Attics and Roofs - Pg. 123	3.0101.1 Air Sealing Holes 3.0102.2 Sealing High-Temperature Devices 3.0102.1 Sealing Non-Insulation Contact (IC) Recessed Light 3.0102.9 Sealing Dropped Soffits/Bulkheads 3.0102.10 Sealing Dropped Ceilings
4.1.1: Sealing Vertical Chases and Chimneys - Pg. 123	3.0101.1 Air Sealing Holes 3.0102.2 Sealing High-Temperature Devices
4.1.2: Air Sealing Recessed Lights - Pg. 126	3.0102.1 Sealing Non-Insulation Contact (IC) Recessed Light 3.0102.2 Sealing High-Temperature Devices
4.1.3: Sealing Stairways and Access Doors - Pg. 129	3.0102.11 Sealing Roof/Wall Connections 3.0103.2 Exterior Roof Access Panels and Hatches 3.0103.1 Access Doors and Hatches
4.1.5: Removing Insulation for Attic Air Sealing - Pg. 131	3.0101.1 Air Sealing Holes
4.1.6: Sealing Joist Cavities Under Knee Walls - Pg. 132	3.0101.1 Air Sealing Holes
4.1.7: Sealing Kitchen or Bathroom Interior Soffits - Pg. 133	3.0102.9 Sealing Dropped Soffits/Bulkheads 3.0102.11 Sealing Roof/Wall Connections

<b>Field Guide Topic</b>	<b>SWS Detail</b>
4.1.8: Sealing Two-Level Attics - Pg. 134	3.0102.11 Sealing Roof/Wall Connections 4.0201 Accessible Walls
4.1.9: Sealing Dropped Ceilings - Pg. 134	3.0102.10 Sealing Dropped Ceilings
4.2: Insulating Attics and Roofs - Pg. 137	4.0101 Exterior Roof Insulation 4.0102 Interior Roof Insulation 4.0103 Attic Floors - Unconditioned Attics 4.0188.2 Unconditioned Attic Ventilation
4.2.1: Preparing for Attic Insulation - Pg. 139	4.0103 Attic Floors - Unconditioned Attics
4.2.2: Safety Preparations for Attic Insulation - Pg. 141	Section 4 Insulation 4.0103 Attic Floors - Unconditioned Attics 2.0301.1 Junctions/Splices Enclosed 2.0301.2 Knob and Tube Wiring - Isolation
4.2.3: Blowing Attic Insulation - Pg. 145	4.0103.2 Accessible Attic - Loose Fill Installation 4.0103.4 Accessible Attic - Loose Fill Over Existing Insulation 4.0103.6 Accessible Attic - Dense Pack Insulation 4.0103.8 Loose Fill to Capacity 4.0188.2 Unconditioned Attic Ventilation
4.2.4: Closed-Cavity Attic Floors - Pg. 146	4.0103.8 Loose Fill to Capacity
4.2.5: Insulating Closed Roof Cavities - Pg. 147	4.0103.7 Accessible Pitched/Vaulted/Cathedralized Ceilings - Loose Fill Over;

<b>Field Guide Topic</b>	<b>SWS Detail</b>
4.2.7: Installing Fiberglass Batts in Attics - Pg. 152	4.0103.3 Accessible Attic - Batt Insulation Over Existing Insulation 4.0103.1 Accessible Attic - Batt Installation
4.2.9: Vaulted Attics - Pg. 154	4.0102.3 Inaccessible Ceilings - Dense Pack
4.2.10: Finished Knee-Wall Attics - Pg. 155	4.0104 Attic Knee Walls 4.0104.1 Knee Wall - Dense Packing 4.0104.2 Knee Wall - Batt Insulation 4.0104.3 Knee Wall - Existing Batt Insulation Repair 4.0104.4 Knee Wall - Rigid Insulation
4.2.11: Knee-Wall Insulation - Pg. 158	4.0104 Attic Knee Walls 4.0104.1 Knee Wall - Dense Packing 4.0104.2 Knee Wall - Batt Insulation 4.0104.3 Knee Wall - Existing Batt Insulation Repair 4.0104.4 Knee Wall - Rigid Insulation
4.3: Cool Roofs - Pg. 164	5.0402 Reflective Roofs
4.4: Landscaping - Pg. 165	5.0401.1 Indigenous Shading



## CHAPTER 5: WALLS

This chapter discusses air sealing and insulation for walls in existing buildings. Air sealing begins by inspecting the discontinuities in walls, such as the following.

- Inside and outside corners of walls.
- Openings for windows and doors.
- Protrusions and indentations in walls.

Insulation begins by evaluating the existing wall insulation and deciding on the feasibility and cost-effectiveness of installing additional wall insulation. Other wall-insulation issues may include the following.

- Whether you can install wall insulation at all, such as in walls already partially insulated.
- Whether to insulate from interior or exterior of the home.
- How to open a wall cavity and restore it after insulating the wall cavity.
- How to install insulation to the wall's surface.

### 5.1 AIR SEALING WALLS

*SWS Detail: 3.0101.1 Air Sealing Holes;*

Most wall air leakage involves the wall's discontinuities, joints, and irregularities.

*See “Material and Sealant Specs” on page 98.*

#### 5.1.1 Multifamily Firewalls

*SWS Detail:3.0102.4 Sealing Firewalls*

Firewalls are structural walls between buildings or dwelling units that prevent the spread of fire from one unit to another. If a firewall isn't monolithic on all sides because of balloon framing, open-cavity CMU, open chases, attic bypasses, or other discontinuity, restore the firewall to code-compliance. Access attic and floor penetrations, basement penetrations, and the vertical-edge penetrations throughout the firewall assembly and seal them.

- ✓ When air sealing, preserve existing fire ratings of materials and assemblies along with existing-material compatibility and comparable durability.
- ✓ Verify that non-monolithic fire walls, such as balloon-framed walls, are airtight assemblies both to air flowing horizontally and vertically.
- ✓ Seal air channels, created by furring strips or wall framing, against a monolithic firewall. At a minimum seal the top and bottom of each channel, and/or densepack the channels with fibrous insulation.
- ✓ Seal gaps and cracks with air-sealing materials and backing materials that are compatible with and similar to existing materials with fire-containment functionality.

*See “Air Sealing and Fire Containment” on page 97. See “Balloon Framed Walls” on page 175. See “Fire Testing and Rating” on page 569. See “Fire Safety” on page 23.*

### 5.1.2 Built-In Cabinets/Shelves

Built-in cabinets and shelves are a feature of older homes and present challenges for air sealing. Sealing these areas from inside the cabinet requires care and attention to appearances.

- ✓ If possible, establish both an air barrier and insulation behind the cabinet, out of sight of the occupants.
- ✓ Install drywall or wood wherever the cabinet is open to a wall cavity after insulating the cavity.

- ✓ Use caulking that is compatible with the colors of the surrounding wood if you seal its interior-facing side.

**Built-ins and other connected air leaks:** Built-in cabinets, a chimney chase, and recessed lights create a major air leakage problem in this living room.



### 5.1.3 Wall Framing Around Fireplaces and Chimneys

*SWS Detail: 3.0102.11 Sealing Roof/Wall Connections; 3.0102.2 Sealing High-Temperature Devices*

Leaks around fireplace chimneys are often severe air leaks. Use this procedure to seal air leaks through the chimney chase.

- ✓ Cut sheet metal to fit the gap that borders the chimney with overlaps connecting to nearby framing lumber.
- ✓ Bed the sheet metal air seal in sealant (ASTM E136), and then fasten the sheet metal to the framing with staples, nails, or screws.
- ✓ Seal the metal patch to chimney or flue with an ASTM 136 compliant, non-combustible sealant.
- ✓ For large chimney chases, cover the chase opening with structural material such as plywood. Maintain clearances between the structural seal and the metal or masonry chimney as listed in *“Clearances to Combustibles for Common Chimneys” on page 326.*

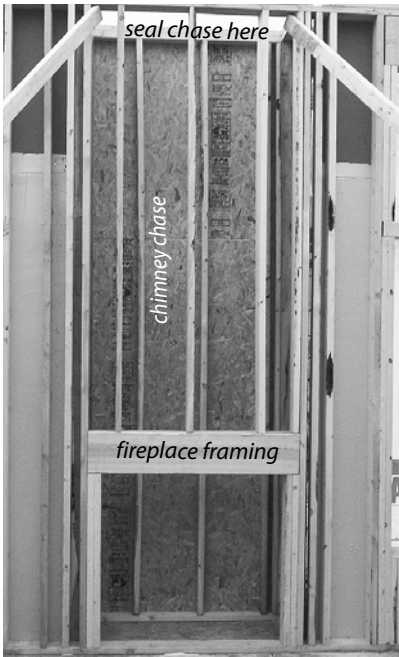

**Chimney chase:** Chimney chases can be multistory air-leak conduits if they're not sealed at floors and ceilings.

### 5.1.4 Pocket Door Cavities

When located on the second floor, cap the top of the entire wall cavity in the attic with rigid board, caulked and mechanically fastened.

Pocket doors connected to the exterior walls present difficult air sealing and insulating challenges. You may need to address these framing situations from the exterior in order to install a durable and efficient repair that provides a good air seal and allows you to install insulation into the exterior wall cavity

## 5.1.5 Cooling Appliances Installed through Walls or Windows

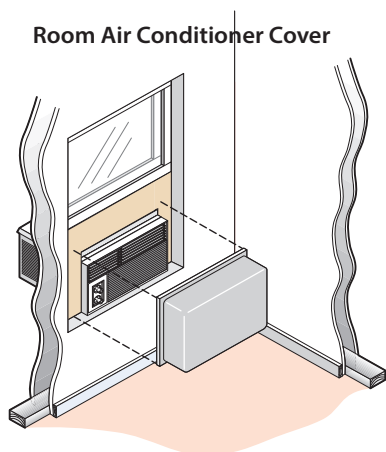

**Room-air-conditioner cover:** If you can't take the unit out for the winter, cover it with a room-air-conditioner cover.

- Remove window units in the fall and re-install in the spring.
- If the client doesn't want to remove the unit seasonally, cover the unit with a room-air-conditioner cover as shown here.
- Units installed through walls should have a sheet-metal sleeve that seals well to the surrounding framing and finish. This metal sleeve provides a smooth surface to seal to the room air conditioner or heat pump.
- Seal the unit's perimeter with one-part foam or caulking, depending on the width of the joint.

## 5.1.6 Balloon Framed Walls

Balloon framed two-story walls are common in older homes. Some modern homes have balloon framed gable walls, where the studs rise above the level of the ceiling joists and are cut at an angle to frame the gable. Even when these balloon framed gable walls are full of insulation, air can convect through the insula-

tion. On occasion, windstorms have blown the insulation out of the wall cavity into the attic.

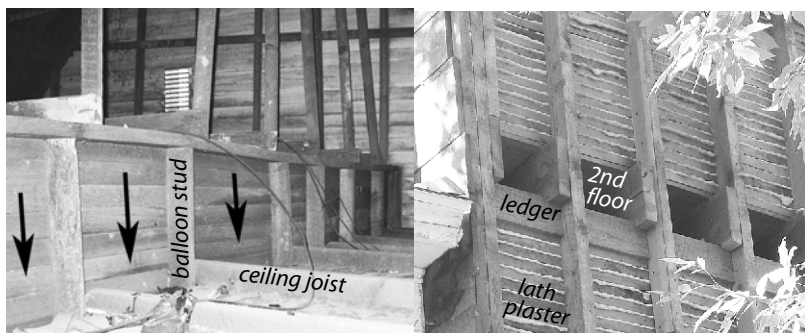

**Balloon framed walls:** Wall cavities, shown from outdoors at right and from the attic at left, are open to the floor cavity, the attic, and the crawl space.

- ✓ Dense-pack insulation into the wall cavities to reduce air leakage and convection.
- ✓ Dense-pack insulation into an air-permeable bag inserted with the fill tube into the balloon-wall floor cavity.
- ✓ Seal stud cavities from the attic, basement, or crawl space with an insulation plug, covered with a 2-part-foam air seal.
- ✓ Or seal the tops and bottoms of cavities with a rigid barrier, such as drywall or plywood, sealed and bonded to surrounding materials with 2-part foam.

*See also "Wall Insulation" on page 180.*

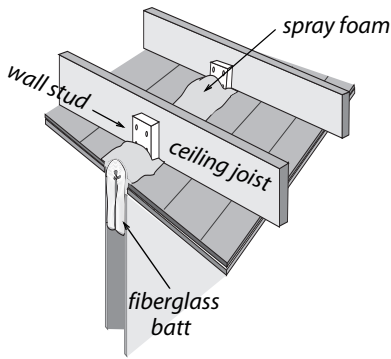

**interior wall**  
**Balloon framed interior walls:**  
 Fiberglass insulation covered by a 1-inch layer of two-part foam seals wall cavities.

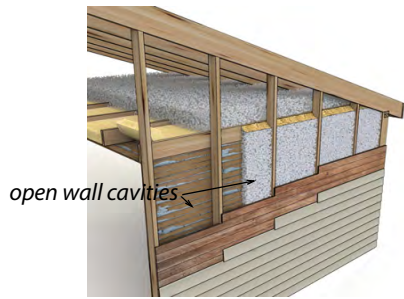

**Balloon framed gable:** Studs extend above the ceiling allowing convection from the attic.

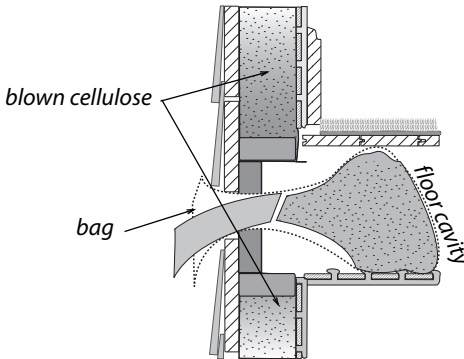

**Sealing wall-floor junction:**  
 Blown insulation reduces convection through walls and floors. A bag helps contain and pack the blown insulation that extends into the floor cavity.

## 5.2 AIR-SEALING SMALL OPENINGS

*SWS Detail: 3.0201 Windows; 3.0202 Doors; 3.0102.3 Sealing Tongue and Groove Surfaces; 3.0103.1 Access Doors and Hatches*

Minor air sealing includes sealing small openings with such materials as caulk or weather stripping. *See “Material and Sealant Specs” on page 98.*

## 5.2.1 Window and Door Frames

*SWS Detail: 3.0202.1 Door Air Sealing; 3.0201.1 Window Air Sealing*

Sealing from the exterior serves to keep bulk water out and protect the building. If the crack is deeper than  $\frac{5}{16}$ -inch, it should be backed with a material such as backer rod and then sealed with caulk. Any existing loose or brittle material should be removed before the crack is re-caulked. *See also "Windows and Doors" on page 233.*

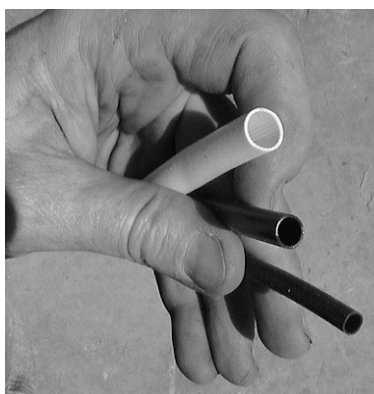

**Silicone bulb weatherstrip:** Silicone bulb has its own adhesive or is adhered to surfaces with silicone caulking.

## 5.2.2 Rim Joist Area

*SWS Detail: 3.0104.1 Closed Crawlspace Air Sealing*

The rim joist area is composed of several joints. They can be sealed from the basement or crawl space with caulk or foam. Remove dust before applying sealant. *See also "Rim-Joist Insulation and Air-Sealing" on page 215.*

## 5.2.3 Masonry Surfaces

Brick and various types of masonry block aren't air barriers. Seal masonry surfaces with a masonry-patching compound, mortar mix, or polyurethane caulking. For cement-based patches, buy a



mix designed for patching. Prime the damaged areas with a masonry primer/adhesive. Liquid water resistant barriers (WRB) are often excellent air barriers.



**Stucco over brick:** This retrofit serves two purposes: air sealing and structural reinforcement.



**Liquid water-resistant barrier:** This retrofit serves two purposes: water proofing and air sealing.

## 5.2.4 Interior Wall Top Plates

Workers install drywall on ceilings after they build interior walls. Thus the top plates of interior walls are open to the attic. Top plates shrink, opening cracks that run the entire length of the interior wall. Move insulation and seal the cracks with caulking or two-part foam.

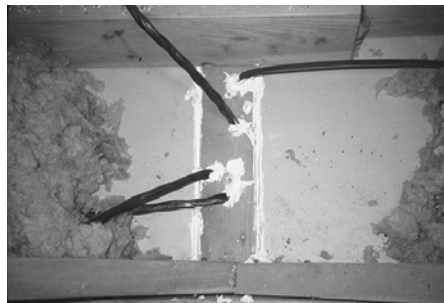
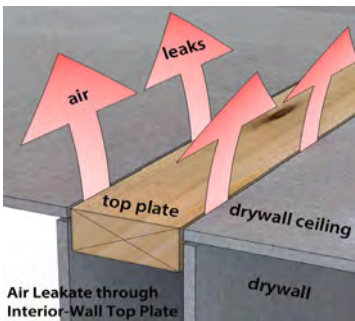

**Leaky top plates:** The cracks along top plates are from lumber shrinkage. They are small cracks but there are long lengths of them.

## 5.3 WALL INSULATION

*SWS Detail: 4.0201 Accessible Walls; 4.0202 Enclosed Walls*

Install wall-cavity insulation with a uniform coverage and density. Wall cavities encourage airflow like chimneys do. Convection currents or air leakage can significantly reduce wall insulation's thermal resistance if channels remain for air to migrate or convect.

**Important:** Provide the client with an insulation receipt or certificate, with the insulation type and number of bags installed, installed thickness, coverage area, and insulation R-value. *See "Insulation Receipt or Certificate" on page 106.*

### Blown Wall-Insulation Types

Cellulose, fiberglass, and open-cell polyurethane foam are the leading insulation products for retrofit-installation into walls.

**Table 5-1: Wall Insulation Density and R-Value per Inch**

Insulation Material	Density	R-Value/in.
Fiberglass (virgin fiber)	2.2 pcf	4.1
Cellulose	3.5 pcf	3.4
Open-cell urethane foam	0.5 pcf	3.8

pcf = pounds per cubic foot

### 5.3.1 Wall Insulation: Preparation and Follow-up

*SWS Detail: 4.0201 Accessible Walls; 4.0202 Enclosed Walls*

Inspect and repair walls thoroughly to avoid damaging the walls, blowing insulation into unwanted areas, or creating a dust hazard.

## Preparing for Wall Insulation

Before starting to blow insulation into walls, take the following preparatory steps.

- ✓ Calculate how many bags of insulation are needed to achieve the R-value specified on the bag's label.
- ✓ Inspect walls for evidence of moisture damage. If an inspection of the siding, sheathing, or interior wall finish shows a moisture problem, don't install sidewall insulation until the moisture problem is identified and solved.
- ✓ Inspect indoor surfaces of exterior walls to assure that they are strong enough to withstand the force of insulation blowing. Reinforce interior sheeting as necessary.
- ✓ Inspect for interior openings or cavities through which insulation may escape. Examples include balloon-framing openings in the attic or crawl space, pocket doors, unbacked cabinets, interior soffits, and openings around pipes under sinks and closets. Seal these openings with airtight, rigid, blocking material to prevent insulation from escaping the wall cavity.
- ✓ Verify that exterior wall cavities aren't used as return or supply ducts. Either avoid insulating these cavities, or remove the ducts and reinstall them somewhere else.
- ✓ Verify that electrical circuits inside the walls aren't overloaded. Maximum ampacity for 14-gauge copper wire is 15 amps and for 12-gauge copper wire is 20 amps.
- ✓ Perform a voltage-drop test to evaluate the size and condition of hidden wiring on older homes. Use a "Sure Test Branch Circuit Analyzer", or similar device that measures the voltage drop at full load (15 amps). Voltage drop may not exceed 5%.
- ✓ Install S-type fuses to prevent circuit overloading if necessary.

- ✓ Don't insulate cavities containing unshielded high-temperature devices — chimneys, flues, vents, wall heaters — unless they are zero clearance devices or unless you can maintain the required clearance.
- ✓ Don't insulate cavities containing knob-and-tube wiring. See *“Electrical Safety”* on page 53.

**Balloon-framed gable wall insulation:** Spray foam plug or other rigid dam prevents insulation from escaping the wall cavity. The dam also prevents air circulation or wind washing through wall insulation.

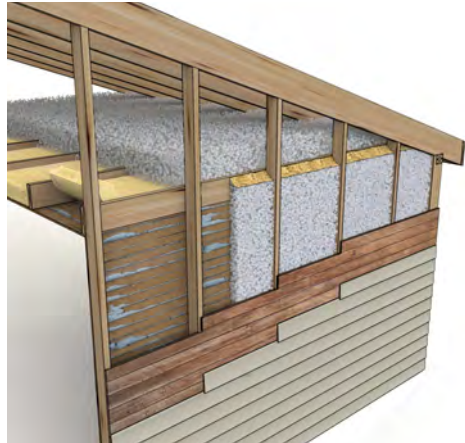

## Patching and Finish after Insulating

The insulators, the home owner, and others should agree about the patching method and the final appearance of the wall finish. The insulators are usually responsible for patching holes and returning the interior or exterior finish to its previous condition or some pre-agreed level of finish. See upcoming sections on various wall finishes for instruction on re-installation and patching.

## Wall Insulation Quality Control

Retrofit wall insulation has more risk of incomplete application than insulation that you can visually inspect. Consider these quality control options to verify the proper coverage and density of retrofit wall insulation.

- Viewing the wall through an infrared camera.

- Looking through an electrical outlet or other access hole for insulation.
- Calculation of installed weight of installed insulation compared to wall-cavity volume and required density.

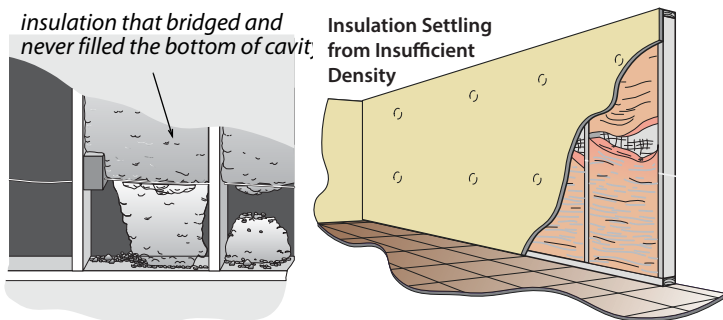

**Problems with low density insulation:** Blowing insulation through one or two small holes usually creates voids inside the wall cavity. This is because insulation won't reliably blow at an adequate density more than about one foot from the nozzle. Use tube-filling methods whenever possible, using a 1.5-inch hose inserted through a 2-inch or larger hole.

### 5.3.2 Retrofit Closed-Cavity Wall Insulation

*SWS Detail:4.0202.1 Dense Pack Insulation; 4.0201.3 Dense Pack Insulation*

This section describes two ways of installing wall insulation.

1. Blowing walls with fibrous insulation using a fill tube from indoors or outdoors.
2. Injecting liquid foam into a closed wall cavity.

### 5.3.3 Accessing Wall Cavities

Mistakes are most common at the beginning of any job. For the sake of appearances, start on the least important part of the house — facing the backyard or another nearby building.

For frame walls with lap siding, remove a row that is between one and 2 feet above the bottom plate for both convenience and to avoid blowing both up and down. Be prepared to patch or replace siding if necessary, depending on your evaluation of its current condition and its difficulty to remove.

## Lath and Plaster or Drywall

If you drill indoors through lath and plaster, use a carbide tip hole saw at least 2 ½ inches in diameter. Assume lead paint if you're not testing, and follow lead-safe precautions carefully.

A butterfly patch, also known as a California patch is probably the best type of patch. The butterfly patch is a piece of drywall with the same size plug as the hole you drilled, surrounded by a larger piece of drywall paper.

Or, patch the hole with a stiff joint compound as a base and standard joint compound as finish. The stiff joint compounds are very difficult to sand, if their surface rises even  $\frac{1}{32}$  inch above the surface of the finished wall, so keep the first layer well below the surface and top the patch off with standard sand-able joint compound.

You can also install a primed and painted trim board horizontally to cover all the holes.

### **The butterfly patch:**

Drywall paper surrounds the circular drywall plug. The paper makes finishing the patch easier and faster. Make a supply of these before starting a job.



## Wood Lap Siding

Wood siding can be difficult to remove and replace without damage, especially if it has several coats of intact paint. Old painted wood can be very brittle and its paint very fragile.

- ✓ Consider the possibility that you may break or split pieces of siding and may need some new siding to replace damaged pieces.
- ✓ Choose a piece of lap siding a comfortable height one or two feet above the bottom plate. To begin, cut your chosen piece of lap siding vertically at the vertical corner trim so that you can remove it after pulling the nails.
- ✓ Use a utility knife or a sharpened putty knife to cut completely through the paint at the bottom of your chosen piece of siding.
- ✓ Pull the nails on the bottom edge of your chosen piece. A ram type nail puller creates less damage to the wood compared to a bar-type nail puller. Or you can lift the siding slightly directly under each nail with a flat bar, and remove the nail.
- ✓ Use a nail punch to drive nails through the siding if you can't pull the nails.
- ✓ After blowing, line up the siding in its original position. Nail the siding back in place using a new hole close to the old one, in order to catch the stud. Don't use the old hole because it may be too large to hold the new nail. Drill holes if you must to avoid splitting the wood.
- ✓ Use galvanized nails, and fill the damage at the nail holes with exterior caulking. Afterwards prime and paint as necessary.



**The last resort:** When you can't find an easier way, cut horizontally the piece you want to remove. Re-install it after you insulate, and face-nail it in place.

## Wood Shingle Siding

First, identify the stud layout in the wall so you know which shingles to remove.

- ✓ Cut the paint on each vertical side of the shingle.
- ✓ Pry the single loose, and pull it down to remove it.
- ✓ Or score the shingle and break it to drill a hole, then face-nail it back in place.
- ✓ Replace the single by pushing it up to the shingle above it, and face nail it with a galvanized box nail.

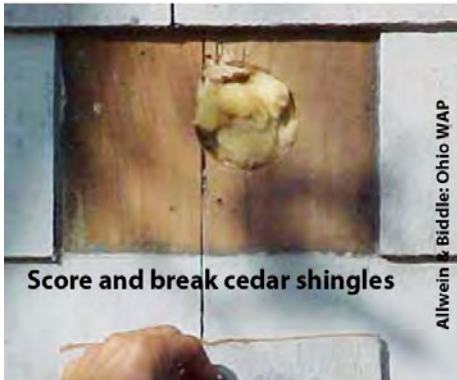

**Score and break a shingle:** If the shingles are flexible, you may be able to remove nails. However, usually you must score and break the shingle, and then later face-nail it back in place.

## Asbestos-Slate Siding

The individual slates of asbestos siding can be easy or difficult to remove depending on whether they are single-nailed or double-nailed. If the slate is only nailed at the bottom, you can pull the



nails and slide them out. You may have to cut the paint around the slate with utility knife.

The standard slate size is 12 by 24 inches and you can buy them in 18-slate bundles online, if you can't find them locally. The slates come in several designs. Ideally, you should have a supply of asbestos slates, in case you break a slate.

- ✓ Open a pair of end nippers a little wider than the head of the nail. Center the nail between the jaws of the nipper and press. Hopefully, pressing the slate moves the slate inward allowing the Nipper blades to squeeze under the nail head. Pull on the nail, but don't use the slate for leverage. Try turning the nail clockwise and counterclockwise with the end nippers. Don't move the nail back-and-forth because it might break the fragile slate. If the nail won't come out, try cutting the head off with the end nippers.
- ✓ Never cut asbestos siding with the saw. Dampen the area of the piece that you'll cut. While the slate sits on a solid surface, score the slate with a scoring knife on both sides. Then line up the scored line even with the straight edge of the supporting surface, and carefully break the slate along the scored line.

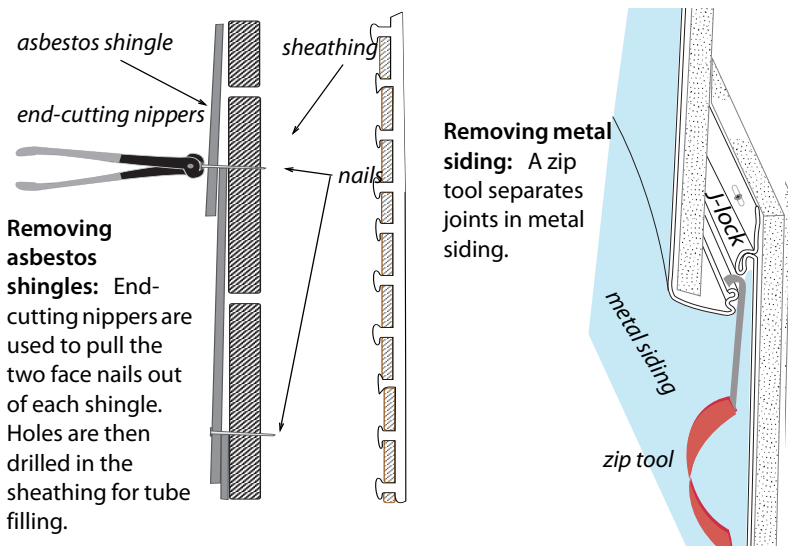

## Metal Lap Siding

Metal siding can be easy or difficult to remove. Steel siding is typically more difficult than aluminum siding. Sometimes you're lucky and a zip tool separates the upper piece of siding from the J lock of the siding piece below it.

- ✓ Start at a corner or a joint, and pry the end of the J lock apart. Start there to unzip the two pieces of siding with the zip tool.
- ✓ Failing that, some installers use a piece of vinyl clothesline with a knot in the end. They insert the clothesline in the space between the siding and the J-lock at one end, and pull the clothesline toward the other end to unzip the joint.
- ✓ Still other installers, use a putty knife and a small flat bar to separate the joint. Others use a hook to separate the J-lock joint at an end or where two pieces of siding join one another.
- ✓ If you can't separate the joint through any of these methods, you can cut the lower piece of siding horizontally and

remove it or bend it downward to drill your holes for the fill tube.

**Pop the corner loose:**

Use a homemade tool, like this one, or a zip tool.



**Lift the upper piece:**

Remove the nails that you expose from the piece below the one you unzipped.



**Remove the lower piece:** Then drill holes for the insulation.

## Vinyl Lap Siding

Vinyl siding is usually the easiest type of siding to remove. On most jobs, an installer simply unzips the joint with a zip tool. Start unzipping at a corner or a joint between two pieces.

## Stucco Siding

First, identify the stud layout in the wall accurately so you know where to cut a hole in the stucco.

- ✓ Cut a 4-inch by 8-inch rectangular hole centered on a stud. This hole gives you access to two stud cavities and leaves you with half as many holes to patch.
- ✓ Pry wire lath open with side nippers or pliers, and remove it.
- ✓ After blowing the wall, stuff the hole with the tuft of fiberglass batt.
- ✓ Place tar-paper patches over the holes you drilled. Then install a rectangular piece of new lath.
- ✓ Apply two coats of stucco. Match the texture with the brush or sponge.

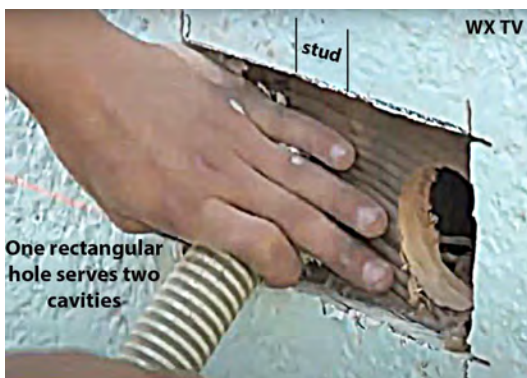

**One hole fills two cavities:** Use a pattern to mark the rectangular hole.

## Masonite Lap Siding

Masonite lap siding is fragile and difficult to pry off its nails.

1. Instead just drive nail heads through the siding with the nail punch to remove it.
2. Fill the nail holes with a paintable caulk or spackle after you insulate.

### 5.3.4 Blowing Walls with a Fill-Tube

Install dense-pack wall insulation using a blower equipped with separate controls for air and material feed.

Select insulation that has a flame spread and smoke development index of 25/450 or less.

#### About Fill Tubes

Use a clear vinyl with  $\frac{1}{8}$  inch wall thickness, 1  $\frac{1}{4}$  inch ID with a 2-inch x 1  $\frac{1}{4}$ -inch reducer.

Cut a 45° angle at the tip to steer the tube around obstacles. The angle of the tip should align with the natural curvature of the tube.

Insulation suppliers provide tubes for summer blowing and winter blowing. The summer blowing tubes are stiffer, and the winter blowing tubes are more flexible. The ideal is flexible enough to avoid obstacles and stiff enough so you can push the tube up to the top of the wall.

Straighten the tube with a heat gun if it's too curvy.



**Accessories for dense-packing walls:** Includes blower hose, 2 types of fill tubes, reducers, and clamps.

Use at least 50 feet of hose between the blowing machine and the fill tube. For example, connect 25 feet of 3-inch hose then a 3-to-2  $\frac{1}{2}$ -inch reducer. Next connect 15 feet of 2  $\frac{1}{2}$ -inch hose and a 2  $\frac{1}{2}$ -to-2-inch reducer. Next attach 10 feet of 2-inch hose and a 2-inch to 1  $\frac{1}{4}$ -inch reducer to attach the fill tube. This type of

stepped-down hose assembly conditions the insulation into a fast flowing aerated stream that distributes and packs the insulation but isn't likely to plug the hose.

Mark the tube with electricians tape or a black permanent marker, 12 inches from the tip of the angle and 8 feet from the tip of the angle. Those two marks tell you when the tube reaches the top of the cavity and when it approaches the bottom. You may be able to feel the tube hit the top plate, when you push it all the way in.

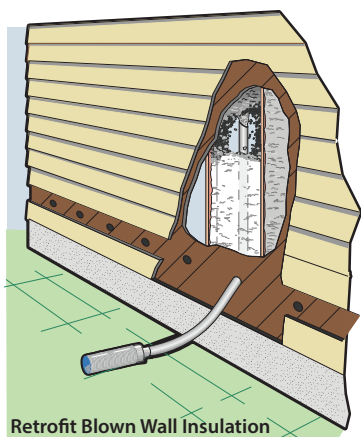

**Tube-filling walls:** perform this method indoors or outdoors. Tube-filling is the preferred wall-insulation method because it achieves a uniform coverage and density.

To prevent settling, blow dry cellulose insulation to 100% coverage and a density of at least 3.5 pounds per cubic foot (pcf). The fiberglass material must be designed for dense-pack installation and must reach at least 2.2 pcf.

Insulate walls using this procedure.

1. Drill 2-to-3-inch diameter holes to access the stud cavities.
2. Probe all wall cavities through these holes, before you begin insulating, to identify fire blocking, diagonal bracing, and other obstacles.

3. Start with several full-height, unobstructed wall cavities so you can measure the insulation density and adjust the blower. An 8-foot cavity (2-by-4 on 16-inch centers) should consume a minimum of 10 pounds of cellulose or 6 pounds of fiberglass.
4. Insert the hose all the way to the top of the cavity. Start the machine, and back the tube out slowly as the cavity fills.
5. Then fill the bottom of the cavity in the same way.
6. After probing and filling, drill whatever additional holes are necessary for complete coverage. For example: above windows or missed areas with fire blocking.
7. Use the blower's remote to control air and feed separately in order to achieve a dense pack near the hole while limiting spillage.
8. Plug the holes with tufts of fiberglass batt, repair the weather barrier at each hole, and re-install the siding.

### Insulating the Wall-Floor Junction of Two-Story Walls

When insulating the perimeter of walls between the first and second floors, blow an insulation plug into the perimeter floor cavities for both thermal resistance and airflow resistance.

This method is effective for both balloon-framed and platform-framed walls. With platform-framed walls, the wall insulation is discontinuous at the floor cavity unless you drill and blow through the rim joist there. With balloon-framed walls, there is a gapping hole at the second floor and no rim joist

This dense-packed plug prevents the second-floor cavity from acting as a thermal bridge and an air-leakage pathway. Using a fill tube, blow the insulation into a air-permeable bag that expands inside the cavity. The bag limits the amount of insulation necessary to insulate the joist cavities at the floor perimeter.

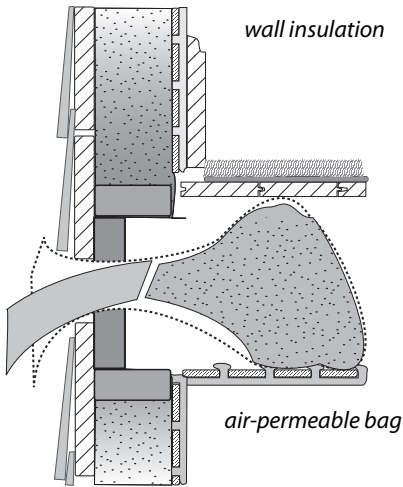

**Floor cavities:** Floor cavities are difficult to fill in platform-framed homes. Blow a plug of insulation into the floor cavity to insulate this uninsulated area.

## Injecting Liquid Foam

Select insulation that has a flame spread and smoke development index of 75/450 or less.

Injecting liquid foam is more expensive than blowing fibrous insulation, but liquid foam provides better performance when existing walls are partially filled by batts. The batts are often 1-to-2 inches thick and fit flush to the interior or exterior wall surface. Try injecting the foam from outdoors to fill the cavity and compress the batt slightly. From indoors, the foam may just stretch the batt facing and fail to create a fully insulated wall cavity.

Open-cell polyurethane foam, formulated to expand less than the sprayed variety, is the leading wall-retrofit foam. Technicians install the foam through holes (<1 inch) spaced about two feet apart using a simple nozzle that barely enters the cavity. Technicians use drinking straws or other indicators to judge the level that the foam has filled during installation. Technicians don't normally use fill tubes to inject open-cell foam because the tube would be too difficult to clean.





**Video: Denspack retrofit insulation tools and procedures**— Hoses, area prep, dense-packing from indoors and outdoors, area cleanup.

### 5.3.5 Open-Cavity Wall Insulation

*SWS Details: 4.0201.2 Batt Insulation; 4.0201.3 Dense Pack Insulation*

Fiberglass batts are the most common open-cavity wall insulation, but rock wool may have a quality advantage over fiberglass. Batts achieve their rated R-value only when installed carefully.

A variety of sprayed insulation products may out-perform batts with expert installation. However, these products are more expensive and have their own installation challenges.

This section describes ways of installing wall insulation.

1. Installing batts in an open wall cavity.
2. Spraying wet-spray fiberglass or cellulose into an open wall cavity.
3. Spray open-cell or closed-cell foam into an open wall cavity.
4. Blowing fibrous insulation behind netting.

**R-15 fiberglass batts:** install unfaced batts as shown on the right. Cut the batts accurately and install them carefully.



### Open-Cavity Batt

- ✓ Use unfaced friction-fit batt insulation where possible. Fluff the batts during installation to fill the depth of the wall cavity.
- ✓ Choose medium- or high-density fiberglass batts: R-13 or R-15 rather than R-11, and R-21 rather than R-19. Or, consider rock-wool batts.
- ✓ Seal all significant cracks and gaps in the wall structure before you install the insulation.
- ✓ Insulate behind and around obstacles with scrap pieces of batt before installing batts.
- ✓ Staple faced insulation to outside face of studs on the warm side of the cavity. Don't staple the facing to the side of the studs because this method leaves an air space that allows convection currents.
- ✓ Cut batt insulation to the exact length of the cavity. A too-short batt creates air spaces above and beneath the batt, allowing convection. A too-long batt bunches and folds, creating air pockets.
- ✓ Split batt around wiring, rather than letting the wiring compress the batt to one side of the cavity.

- ✓ Fiberglass insulation, exposed to the interior living space, must be covered with a thermal barrier or at least half-inch drywall or other material with a flame-spread rating of 25 or less.
- ✓ Fiberglass batts exposed to unoccupied spaces like attics must be covered with an air barrier such as house wrap or foam sheeting to prevent R-value degradation by convection and human exposure to fibers.

See “Fiberglass Batt and Blankets” on page 107.

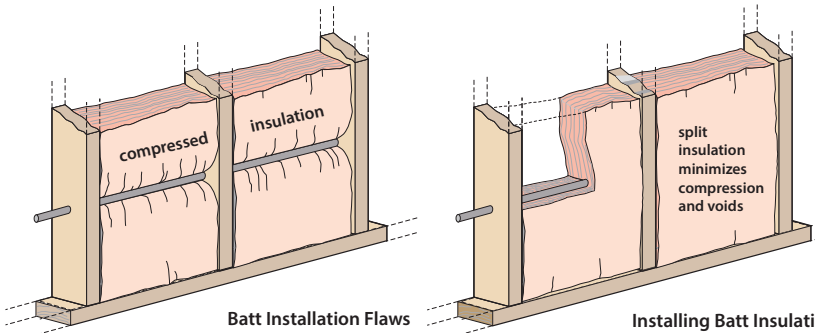

**Fiberglass batts, compressed by a cable:**  
This reduces the wall’s R-value by creating a void between the insulation and interior wallboard.

**Batt, split around a cable:** The batt attains its rated R-value.

## Sprayed Open-Cavity Wall Insulation

Both fibrous and foam insulation can be sprayed into open wall cavities. Varieties include the following.

- Fiberglass or cellulose mixed with water and glue at a special nozzle sprayed into the open wall cavity with the excess shaved off (fibrous damp-spray insulation)
- Open-cell or closed-cell polyurethane foam sprayed into an open wall cavity. Installers either spray the foam short of filling the whole cavity or shave off the excess foam after it cures.

- Select insulation that has a flame-spread /smoke-developed index of 75/450 or less.

**Spray fibrous insulation:** Installers blow wet-spray fibrous insulation into cavities and shave off the excess.



### Blowing Open Wall Cavities behind Netting or Fabric

Blowing dry fibrous insulation behind netting or fabric is a common way of insulating open walls before drywall application, especially with cellulose. However, you must install the insulation to a sufficient density to resist settling.

- ✓ Select insulation that has a flame spread and smoke development index of 75/450 or less.
- ✓ Select a restrainer netting or fabric that supports the above densities without bulging excessively.
- ✓ Fasten the netting or fabric with power-driven staples, 1.5 inches apart.
- ✓ Verify density of at least 3.5 pcf for cellulose or 2.2 pcf for fiberglass.
- ✓ Roll bulging insulation with a roller to facilitate drywall installation.



### **Video: Using 2-part and 1-part spray foam**

— Hands-on demonstration of using these two insulation materials.

## 5.3.6 Insulated Wall Sheathing

### *SWS Detail: 4.0202.2 Exterior Rigid Insulation*

Insulated sheathing is an excellent retrofit, when you replace the siding and windows. Insulated wall sheathing covers an interior or exterior wall surface with insulation, reducing thermal bridging through structural framing.

Always fill the wall cavity with insulation before installing insulated sheathing. Insulating wall sheathing is usually foam board, such as polystyrene or polyisocyanurate. Comply with these specifications.

1. Seal all holes, gaps, and penetrations in existing sheathing.
2. Some multifamily siding-replacement jobs require a “thermal barrier” like drywall as exterior sheathing for fire containment.
3. Verify that the existing exterior wall has a functional water-resistive barrier (WRB). House wrap, perforated tar paper, or the foam insulation itself may function as the WRB. However, consult with your building department to verify.
4. Fasteners should penetrate wood structure at least 1.5 inches.
5. Seal all insulation seams, joints and connections in each foamboard layer with compatible sealant — caulk, tape, or mastic, for example.

*See also "Foundation Wall Insulation" on page 222.*



**Rigid-foam fasteners for masonry:** Installers use power drivers to fasten rigid foam to masonry materials.

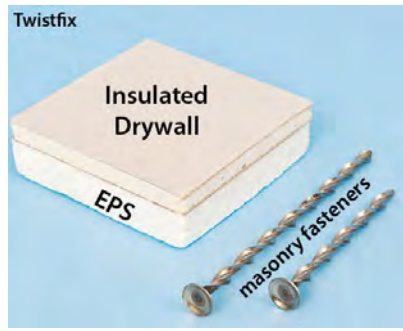

**Insulated drywall:** This specialty product works well for masonry and plaster interior walls.

## Fasteners for Insulated Sheathing

Fastening the insulating sheathing requires one of the following to secure the insulation to the wood sheathing or masonry under it.

- A batten board
- An embedded strip
- A broad staple
- A long wood or masonry screw with a large washer
- A special adhesive (masonry)

Use appropriate fasteners for bonding foam to wood or masonry materials. Wood battens or embedded strips allow attachment of a variety of siding materials. The embedded strips work best with steel, aluminum, or vinyl sidings, which are lightweight and which drain rain water through weep holes in every piece of siding.

If you plan to use a heavy siding, such as fiber cement or traditional stucco, consult a structural engineer to verify that the fasteners can adequately support the heavy siding.



**Foam sheathing with battens:** One-by-four battens are applied to 4 inches of foam board on the exterior to provide a fastening strip for siding and trim.

**Foam with embedded strips:** Strips of plywood or OSB are spaced on 16 or 24 inch centers at the factory. Wide corner pieces can be added on the job with foam cutting and grooving tools.



### 5.3.7 Wall Insulation in a Retrofitted Frame Wall

Retrofitters, seeking superior energy performance, sometimes build a wood-frame wall attached to the interior or exterior of the existing wall. Common insulation choices include all the wall-insulation choices discussed previously.

Select insulation that has a flame spread and smoke development index of 75/450 or less.

Workers must install vapor retarders, and air barriers into the new wall assembly as appropriate for the climate and existing wall characteristics. The exterior side of a retrofitted insulated frame should have sheathing and a water resistive barrier like house wrap.



**Frame wall for insulation:**

Technicians fastened a frame wall with brackets that place the wall away from the existing exterior wall by a half inch so that the sprayed foam can flow behind the studs and plates to reduce thermal bridging.



**Open-cell polyurethane foam:** The foam was sprayed into the cavities and the excess shaved off. New sheathing, house wrap, siding, and windows follow later.

### 5.3.8 Insulating Unreinforced Brick Walls

Unreinforced means that the builders used no steel or other metal reinforcement. There are three types of unreinforced brick walls.

1. Traditional brick walls with header bricks that hold two layers of stretcher bricks together. Larger buildings may have three or more brick layers instead of two.
2. Various types of cavity brick walls with usually one layer of brick on either side of a cavity.
3. Wood-frame brick veneer walls with a single layer of brick veneer that attaches to a typical wood frame wall with a cavity between the brick and the wood-frame wall up to 2 inches.

All three of these brick assemblies may have structural problems depending on the condition of the bricks and mortar joints. Mortar can turn to dust over many decades; cavity brick walls can be frighteningly fragile; and small movements can topple 100-year-old brick veneer. **Consult a structural engineer**



**before making any modification to an unreinforced brick building.**

*See also "Basement Wall Insulation" on page 225.*



**Cavity brick wall:** Two separate single brick walls are held together by wood lath embedded in the mortar joint.

**Injectable foam:** Installers inject low-density foam into a cavity behind a single brick wall.

## 5.4 SWS ALIGNMENT

<b>Field Guide Topic</b>	<b>SWS Detail</b>
5.1: Air Sealing Walls - Pg. 171	3.0101.1 Air Sealing Holes;
5.1.1: Multifamily Firewalls - Pg. 171	3.0102.4 Sealing Firewalls
5.1.3: Wall Framing Around Fireplaces and Chimneys - Pg. 173	3.0102.11 Sealing Roof/Wall Connections
5.2: Air-Sealing Small Openings - Pg. 177	3.0201 Windows
	3.0202 Doors
	3.0102.3 Sealing Tongue and Groove Surfaces
5.2.1: Window and Door Frames - Pg. 178	3.0202.1 Door Air Sealing
	3.0201.1 Window Air Sealing
5.3: Wall Insulation - Pg. 180	4.0201 Accessible Walls
	4.0202 Enclosed Walls

<b>Field Guide Topic</b>	<b>SWS Detail</b>
5.3.1: Wall Insulation: Preparation and Follow-up - Pg. 180	4.0201 Accessible Walls 4.0202 Enclosed Walls
5.3.5: Open-Cavity Wall Insulation - Pg. 195	4.0201.2 Batt Insulation 4.0201.3 Dense Pack Insulation
5.3.6: Insulated Wall Sheathing - Pg. 199	4.0202.2 Exterior Rigid Insulation

## CHAPTER 6: FLOORS AND FOUNDATIONS

*SWS Detail: 3.0104 Foundation Spaces; 4.03 Floors*

The importance of defining the thermal boundary at the building's lower reaches depends on how much of the building's heat loss is moving through the foundation or floor. The building's thermal boundary may not be obvious because of the lack of insulation at both the floor and the foundation. The building owner and energy auditor must choose where to insulate and air seal if these ECMs are cost-effective.

Either the first floor or the foundation wall is the thermal boundary. After choosing, air seal and insulate the chosen thermal boundary.

*See “Material and Sealant Specs” on page 98.*

### 6.1 THERMAL-BOUNDARY DECISIONS: FLOOR OR FOUNDATION

*SWS Detail: 4.03 Floors; 3 Air Sealing; 3.0101 General Air Sealing; 3.0102 Specific Air Sealing; 3.0104 Foundation Spaces*

The results of air-barrier tests can help in selecting the thermal boundary's location. *See “Air Leakage Diagnostics” on page 539.*

Before you can confidently air seal a building assembly, you must often decide which of two assemblies — the foundation walls or the floor for example — to air seal and insulate.

Moisture problems, the location of heating and cooling equipment, and the necessity of crawl-space venting are other important considerations.

**House-to-crawl-space pressure:**

Many homes with crawl spaces have an ambiguous thermal boundary at the foundation. Is the air barrier at the floor or foundation wall? Answer: in this case, each forms an equal part of the home's air barrier.

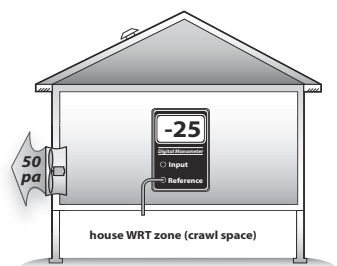

The tables presented next summarize the decision factors for choosing between the floor and the foundation wall as the air barrier. You may also encounter situations that aren't addressed here.

When a home has a basement and crawl space connected, both [Table 6-1 shown next](#) and [Table 6-2 on page 208](#) are relevant to the decision-making process of selecting the air barrier and site for insulation, if insulation is cost-effective. A basement may even be divided from its adjoining crawl space to enclose the basement within the thermal boundary and to place the crawl space outside the thermal boundary.

**Table 6-1: Crawl Space: Where Is the Thermal boundary?**

<b>Factors favoring foundation walls</b>	<b>Factors favoring floors</b>
ground-moisture barrier and good perimeter drainage present or planned	Dry crawl space with ground-moisture barrier installed during weatherization
Foundation walls test tighter than floor	Floor air-sealing and insulation are reasonable options, considering access and obstacles
Vents can be closed off	Floor tests tighter than foundation walls
Furnace, ducts, and water pipes located in crawl space	No furnace or ducts present
Concrete or concrete block walls are easily insulated	Building code or code official forbids closing vents
Floor air-sealing and insulation would be more difficult than sealing and insulating the foundation	Rubble masonry foundation wall
Foundation wall is insulated	Floor is already insulated
Warm, damp homesite + climate	Cooler, drier homesite + climate

**Table 6-2: Unoccupied Basement: Where Is the Thermal Boundary?**

<b>Favors foundation wall</b>	<b>Favors floor</b>
Ground drainage and no existing moisture problems	Damp basement with no solution during weatherization
Interior stairway between house and basement	Floor air-sealing and insulation is a reasonable option, considering access and obstacles
Ducts and furnace in basement	No furnace or ducts present
Foundation walls test tighter than the floor	Floor tests tighter than foundation walls
Basement may be occupied some day	Exterior entrance and stairway only
Laundry in basement	Rubble masonry foundation walls
Floor air-sealing and insulation would be very difficult	Dirt floor or deteriorating concrete floor
Concrete floor	Cracked foundation walls

## 6.2 AIR SEALING FOUNDATIONS AND FLOORS

*SWS Detail: 3 Air Sealing; 3.0101 General Air Sealing; 3.0102 Specific Air Sealing; 3.0104 Foundation Spaces*

The floor and foundation are complex structures that can be difficult to air seal. This section describes the most problematic air leakage locations in the floor and foundation, and how to seal them.

*See “Material and Sealant Specs” on page 98.*

## 6.2.1 Garages Underneath Living Areas

*SWS Detail: 3.0105.1 Isolating Garage From Living Space; 3.0102.3 Sealing Tongue and Groove Surfaces; 3.0102.2 Sealing High-Temperature Devices; 3.0102.1 Sealing Non-Insulation Contact (IC) Recessed Light*

Whenever a garage is in a subspace below living areas, the effectiveness of air sealing is essential for three objectives.

1. Block air pollutants,
2. Create a fire barrier,
3. Save energy by separating the unconditioned garage from the building's conditioned zones.

Air-sealing a garage area is straightforward although this task can consume a lot of materials.

- For wood-frame structures, use fire-taped drywall throughout the surface area of the garage after sealing leaks in the floor above and the in the top plate of the walls.
- For concrete and masonry structures, carefully seal cracks and penetrations with compatible materials such as mortar and caulk designed for masonry joints.

## 6.2.2 Plumbing Penetrations

*SWS Detail: 3.0101.1 Air Sealing Holes; 3.0104.1 Closed Crawlspace Air Sealing; 3.0104.3 Slab Foundation Sealing; 3.0104.4 Covers for Intentional Slab Penetrations*

Seal gaps with expanding foam or caulk. If the gap is too large, stuff it with fiberglass insulation, and spray foam over the top to seal the surface of the plug.

- ✓ Fit large openings with a rigid patch bedded in a sealant like latex caulk or foam tape, which isn't an adhesive.

- ✓ Screw the patch in place, so that a plumber can remove the screws if necessary for access.
- ✓ Seal holes and gaps around pipes with expanding foam or caulk.

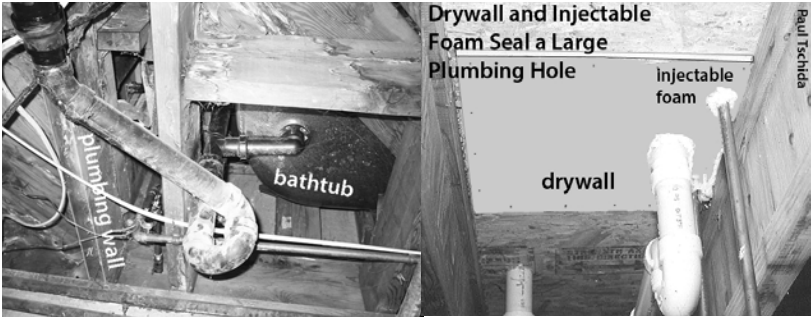

**Sealing large plumbing penetrations:** Bed drywall or wood sheathing in sealant and fasten with nails or screws. Fill gaps around the penetrations with one-part foam to complete this airtight seal.

### 6.2.3 Stairways to Unconditioned Areas

#### *SWS Detail: 3.0101.1 Air Sealing Holes*

A variety of stairways and hatchways provide access from the building to an unconditioned basement.

The following components of these stairways may need air sealing and insulation depending on whether they are at the thermal boundary.

- The risers and treads of the stairways
- The surrounding triangular walls
- Vertical or horizontal doors or hatches
- The framing and sheeting surrounding the doors or hatches
- Sloping ceilings above the stairways

Consider the following air-sealing measures.



- ✓ Study the geometry of the stairway and decide where to establish the air barrier and install the insulation.
- ✓ Weatherstrip around doors and hatches if the door or hatch is at the thermal boundary.
- ✓ Seal the walls, stair-stringer space, and ceiling if they are at the thermal boundary.
- ✓ Seal gaps around door frame or hatch frame perimeters with one-part foam, two-part foam, or caulking.

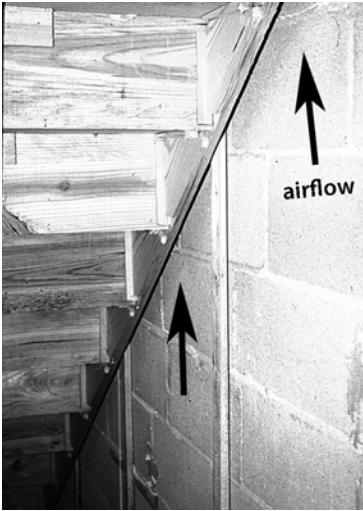

**Unfinished stairways:** Unfinished spaces underneath stairs create major air leakage pathways between floors and between the attic and crawl space or basement.

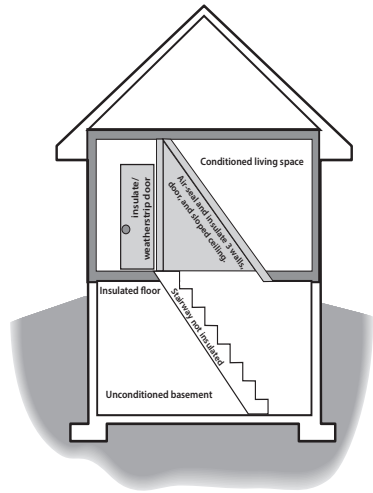

**Stairways at the thermal boundary:** The stairway may be within the thermal boundary or outside it. Only walls, ceilings, doors, and hatches at the thermal boundary require thorough air sealing. The door as shown is open.



**Stairway wall within the thermal boundary:** Double wall forming the stairwell connects an unfinished area under the basement stairs with the living spaces, attic, and the space behind the finished basement walls.

## 6.2.4 Incomplete Finished Basements

*SWS Detail: 3.0101.1 Air Sealing Holes; 4.0402.4 Basements - Without Groundwater Leakage; 4.0402.5 Basements - With Groundwater Leakage*

Discontinuous wall segments can allow heated basement air to circumvent the finished and insulated wall, carrying heat with it. Complete the finished walls or at least install air barriers between finished living area and unconditioned area between the insulated wall and the foundation wall. Here are two suggestions.

- ✓ Bridge the gap with wood sheeting, bedded in sealant, and caulk the crack around four sides of this long narrow patch.
- ✓ Stuff the gap with pieces of fiberglass batt and spray two-part foam over the gap, at least an inch thick.

*See also "Basement Wall Insulation" on page 225.*

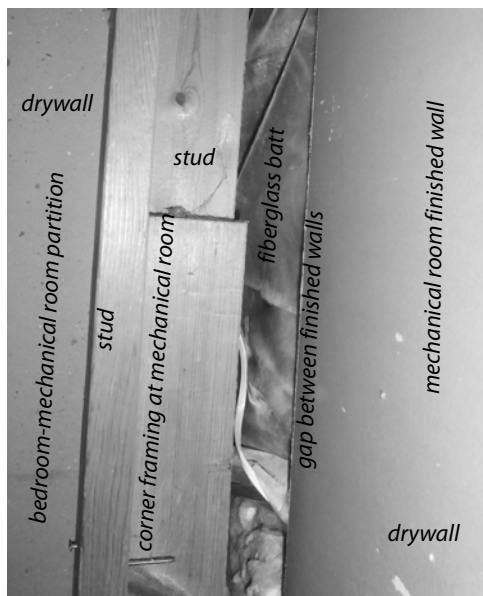

**Large air leak in finished basement walls:** Two finished basement walls meet inside a mechanical room and form a 2-inch gap from floor to ceiling connecting the finished basement with the space behind its finished walls.

## 6.2.5 Cantilevered Floors

*SWS Detail: 4.0301.6 Cantilever Floor Joisted Cavities Batt Insulation; 3.0101.1 Air Sealing Holes; 3.0102.3 Sealing Tongue and Groove Surfaces; 4.0302 Exposed Floors; 4.0302.1 Batt Insulation With Rigid Barrier; 4.0302.3 Dense Pack with Rigid Barrier*

Floors that hang over their lower story are called cantilevered floors. The underside of the overhanging floor can leak considerably. Many balconies and bay windows have cantilevered floors that leak air into a building's floor cavity.

**Cantilevered floors under construction:** Cantilevered floors allow air leakage into floor cavities because of the lack of sealant and dense-packed insulation.

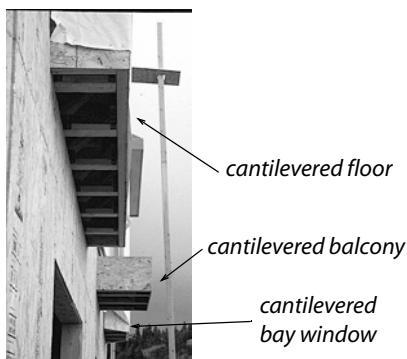

### Fill Cavities with Fibrous Batts

- ✓ Remove a piece of soffit under the overhanging floor to determine the condition of insulation and air barrier.
- ✓ Stuff the overhanging floor with fiberglass or rock wool batts.
- ✓ Bed the sheeting underneath the overhanging floor in sealant where possible. Caulk joints and seams where the sheeting isn't bedded in sealant.
- ✓ Seal any ducts you find in the cantilevered floor sections.

### Dense-Pack Cavities from a Drilled Hole

- ✓ Drill a hole at least 1.5 inch in diameter.

- ✓ Dense-pack fibrous insulation into the cavity.
- ✓ Seal all holes and cracks with an appropriate sealant.

*See also "Installing Floor Insulation" on page 216.*

## 6.3 PREPARING FOR FOUNDATION OR FLOOR INSULATION

*SWS Detail: 3 Air Sealing; 4.0401 Rim/Band Joist*

Floor and foundation insulation can increase the likelihood of moisture problems. Installers should take all necessary steps to prevent moisture problems from ground moisture before installing insulation. *See also "Reducing Moisture Problems" on page 33.*

### 6.3.1 Rim-Joist Insulation and Air-Sealing

*SWS Detail:4.0401.2 Batt Insulation; 4.0401.3 Rigid Insulation*

The rim-joint spaces at the perimeter of the floor are a major weak point in the air barrier and insulation. Insulating and air sealing both the rim joist and longitudinal box joist are appropriate either as individual procedures or as part of floor or foundation insulation.

Air seal stud cavities in balloon-framed homes as a part of insulating the rim joist. Air seal other penetrations through the rim before insulating. Two-part spray foam is the most versatile air sealing and insulation system for the rim joist because spray foam air seals and insulates in one step.

Polystyrene or polyurethane rigid board insulation are also good for insulating and air sealing the rim joist area. When the rim joist runs parallel to the foundation wall, the cavity may be air sealed and insulated with methods similar to those as shown here.

If you leave the spray foam exposed, it should have a flame spread of 25 or less and be no more than 3.25 inches thick according to the IRC. In habitable spaces, cover all foam with a thermal barrier such as drywall or use an insulation product that doesn't require a thermal barrier like mineral wool boards and foil-faced PIC.

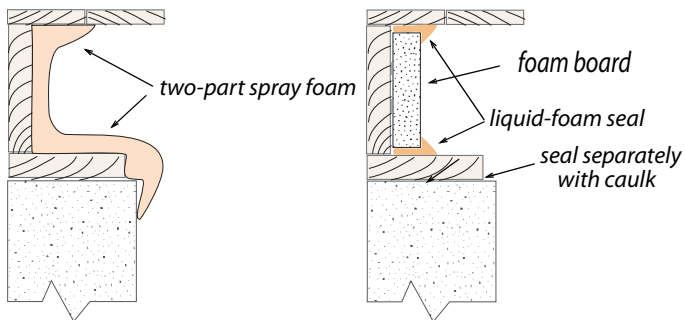

**Foam-insulated rim joists:** Installing foam insulation is the best way to insulate and air seal the rim joist.

**Foam-insulated rim joists:** Here 4 inches of EPS foam is sealed around its perimeter with one-part foam.



Don't use fiberglass batts to insulate between rim joists because air can move around the fiberglass, causing condensation and encouraging mold on the cold rim joist. If you use foam to insulate between the rim joists, use liquid foam sealant to seal around the edges of the rigid foam.

## 6.4 INSTALLING FLOOR INSULATION

*SWS Detail: 4.03 Floors; 4.0301 Accessible Floors; 4.0302 Exposed Floors; 3.0102.2 Sealing High-Temperature Devices*

Before installing floor insulation, make the following preparations.

- ✓ Seal air leaks in the floor from the living space, the crawl space, or the basement, as opportunity allows.
- ✓ Seal and insulate ducts remaining in the crawl space or unconditioned basement.
- ✓ Identify electrical junction boxes, plumbing valves, and drains before insulating, and provide access to them.
- ✓ Insulate water lines in cold climates if they protrude below the insulation.
- ✓ Treat high-temperature devices — non-IC rated recessed lights, chimneys, flues, vents — unless they are zero clearance devices as shown in [“Sealing Vertical Chases and Chimneys” on page 123](#).
- ✓ Install flags that are visible below the floor joists at utility junctions for future identification and verify that utility junctions remain accessible.
- ✓ Post a dated receipt signed by the installer that includes: installed insulation type, coverage area, installed thickness, and installed R-value.

## 6.4.1 Blowing Floor Insulation

*SWS Detail: 4.0301.2 Loose Fill With Netting/Fabric in Joisted Cavities; 4.0301.3 Loose Fill in Joisted Cavities With Rigid Barrier; 4.0301.4 Dense Pack in Joisted Cavities With Rigid Barrier; 4.0301.8 Non-Joisted Floors Rigid Foam*

The best way to insulate a floor cavity is to completely fill each joist cavity with fiberglass insulation. Blowing fiberglass insulation is the easiest way to achieve complete coverage because the blown fiberglass is able to surround obstructions and penetrations better than fiberglass batts. Avoid blown cellulose because of its weight, moisture absorption, and tendency to settle.

- ✓ Cover the entire under-floor surface with a vapor permeable supporting material such as: dust-free fabric insulation restraint or equivalent vapor-permeable and drainable material.
- ✓ Use wood strips to support the flexible or semi-flexible support material unless that material with its fasteners can support the floor insulation with a minimum of sagging.

**Blown floor insulation:** This method works particularly well with floor trusses.

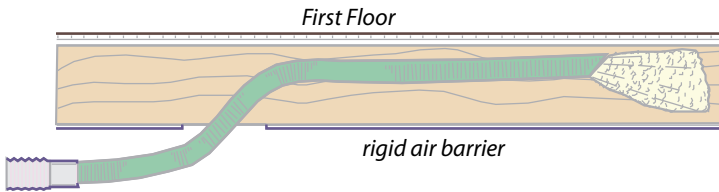
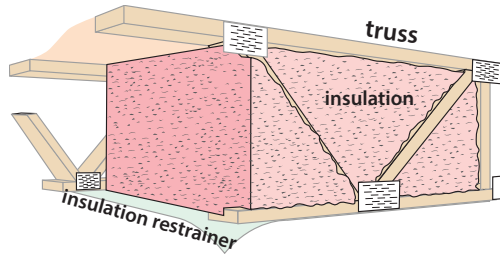

**Blowing floor cavity:** Uninsulated floor cavities can be blown with fiberglass or rock wool insulation, using a fill tube.

- ✓ Install rock wool or fiberglass blowing wool through V-shaped holes in the air barrier.
- ✓ Use a fill tube to install the blown insulation. Insulation must travel no more than 12 inches from the end of the fill tube.





**Insulation restraint:** Workers patched access holes after they blew this floor through an air barrier.



**Flash and batt:** An inch of high-pressure foam seals the cavities and the correctly-sized batts complete the insulation job.

## 6.4.2 Installing Fiberglass Batt Floor Insulation

*SWS Detail: 4.0301.1 Batt Insulation in Joisted Cavities; 4.0301.7 Non-Joisted Floors Batt Insulation*

Observe these material and preparation specifications for insulating under floors.

- ✓ Seal all significant air leaks through the floor before insulating the floor, using strong airtight materials.
- ✓ Choose unfaced batts for insulating floors.
- ✓ Batt thickness must fill the complete depth of each cavity.
- ✓ Batts must be neatly installed, fitting tightly together at joints, fitting closely around obstructions, and filling all the space within the floor cavity.
- ✓ Insulate crawl-space access doors, adjacent to a conditioned space, to at least R-21 for horizontal openings and to at least R-15 for vertical openings.
- ✓ Weatherstrip crawl-space access doors, adjacent to a conditioned space.

- ✓ Post a dated receipt signed by the installer that includes: installed insulation type, coverage area, installed thickness, and installed R-value.

## Installation Specifications for Batts in Floor Cavities

Batt insulation, installed in floors, must be supported by twine, wire, wood lath or other suitable material that keeps the insulation touching the floor. Friction-fit fiberglass batts supported by self-supporting wire insulation supports aren't good practice because the supports often fail. Fasteners for floor insulation must resist gravity, the weight of insulation, and moisture condensation.

- ✓ Install batts in continuous contact with the subfloor.
- ✓ Cut the batts accurately and squarely. Insulation knives or electric carving knives are excellent tools for this purpose.

Use one of the following 4 restrainer materials to keep the fiberglass batts in the floor cavity.

1. Install standard wood lath ( $\frac{1}{4}$  inch by 1 inch) or nominal one-inch lumber. Install the lath or lumber perpendicular to joists 12 inches apart for joists on 24-inch centers and 18 inches apart for joists on 16-inch centers.
2. Install non-stretching polypropylene or polyester strapping or twine.
3. Install copper or stainless steel wire with a minimum diameter of 0.04 inches or size 18 AWG.
4. Install a rigid vapor-permeable air barrier, such as asphalt-impregnated fiberboard.

Observe these requirements about installation and fasteners for the restrainers.

- Fasten lath or a rigid barrier with screws, nails, or power-driven staples. The fastener should penetrate the joist  $\frac{3}{4}$  inch or more.

- Install twine or wire in a zig-zag pattern.
- Install power-driven staples over the strapping, twine, or wire 12 inches apart for joists on 24-inch centers and 18 inches apart for joists on 16-inch centers. The staples must penetrate the wood joists by at least  $\frac{5}{8}$  inch. Don't hand staple the restrainer.

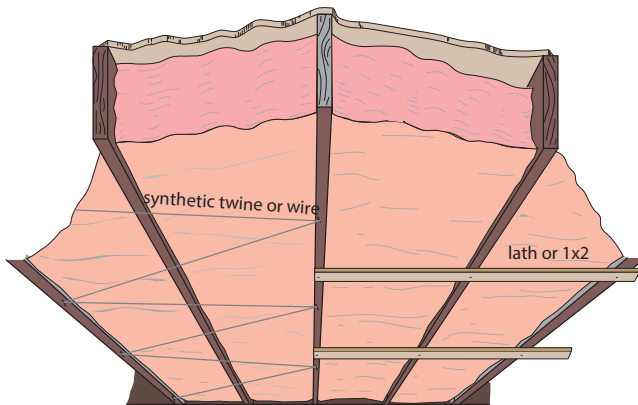

**Floor insulating with batts:** Use unfaced fiberglass batts, installed flush to the floor bottom, to insulate floors. The batt should fill the whole cavity if it is supported by lath or plastic twine underneath.

### 6.4.3 Rigid Foam Floor Insulation

*SWS Detail: 4.0301.8 Non-Joisted Floors Rigid Foam; 4.0302.5 Rigid Insulation on Joists*

#### Foam Material Specifications

- ✓ Select insulation and support materials that have a flame-spread/smoke-developed index of 75/450.
- ✓ Separate all foam products from living space with a thermal barrier material:  $\frac{1}{2}$  gypsum wallboard or equivalent.
- ✓ If a crawl space is used only for servicing utilities, separate the foam from the space using an ignition barrier covering or coating, such as intumescent paint.



**Non-joisted floors with rigid foam:** Workers fasten rigid foam to a non-joisted floor with plastic-cap nails.

## 6.5 FOUNDATION WALL INSULATION

*SWS Detail: 3.0104.1 Closed Crawlspace Air Sealing; 4.0402.1 Closed Crawlspace - Non-Foam Insulation; 4.0402.2 Closed Crawlspace - Rigid Foam Insulation*

Crawl-space foundation insulation is only worthwhile if you can seal the existing foundation vents.

*See "Ground-Moisture Barriers" on page 44.*

*See "Power-Ventilated Crawl Spaces" on page 445.*

### Foundation Wall Insulation Material

Observe these insulation specifications for insulating foundation walls.

- Any foam foundation-wall insulation should be labeled ASTM E84 or UL 723 with a flame spread of less than 25 and smoke developed value of less than 450.
- Protect foam insulation by intumescent paint or another ignition barrier if not labeled ASTM E84 or UL 723.
- Local building officials may approve other foam materials based on product labels such as NFPA 286, FM 4880, UL 1040, or UL 1715.

- Unfaced mineral fiber insulation, greater than 5 pounds per cubic foot in density. Although expensive, mineral wool board is probably the best choice because it is vapor permeable and non combustible.
- Metal fasteners should carry a label of ASTM B 695 Class 55.

These insulation products might meet some of the above specifications.

- Foil-faced polyisocyanurate.
- Expanded polystyrene foam board.
- Unfaced rock wool board or fiberglass board.

**Foam-insulated foundation wall:** A 20-gauge galvanized-steel termite shield and a 10 mil ground-moisture barrier protect the wood floor against termites and other pests.

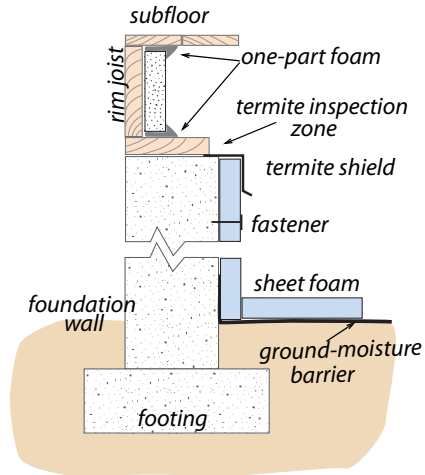

## Safety and Durability

Consider the following issues when insulating foundation walls.

- ✓ Secure outdoor access hatches to foundation walls. If the foundation walls are insulated, also insulate any crawl-space access hatch with foam to the same R-value of the foundation wall.
- ✓ Remove obstacles and debris from crawl space before retrofit.

- ✓ If an open-combustion appliance is located in a crawl space, verify that outdoor combustion air is available to the appliance.
- ✓ When insulating crawl-space walls, consult the local building inspector about acceptable ventilation options if in doubt. *See "Crawl Space Ventilation" on page 444.*

In regions affected by termites, carpenter ants, and similar insects consider these suggestions.

- ✓ Leave a termite-inspection zone between the foundation and the rim-joint insulation.
- ✓ Apply insulation with moisture control measures, pesticide, or baiting.
- ✓ Consult with experts to ensure that the insulation, air sealing materials, and moisture barrier don't provide a conduit for insects to infest the wood floor.

### 6.5.1 Crawl-Space Wall Insulation

Retrofit foundation insulation is usually installed on the inside of the foundation walls. Contractors undertake this retrofit for both energy savings and moisture control. *See "Solutions for Moisture Problems" on page 36.*

Consider these issues with the use of fibrous insulation in crawl spaces.

- Fiberglass batts or blankets are poor choices for foundation insulation because their facing is a vapor retarder. The facing can trap moisture in the fiberglass between the foundation wall and the facing.
- Sprayed fiberglass and cellulose are easily damaged by moisture, mechanical abrasion, and adhesive failure.

## 6.5.2 Basement Wall Insulation

*SWS Detail: 4.0402.4 Basements - Without Groundwater Leakage; 4.0402.5 Basements - With Groundwater Leakage*

Before installing basement wall insulation, inspect for moisture problems and take appropriate action to solve moisture problems.

- ✓ Check for bulk-water problems like puddling around the foundation or malfunctioning gutters and downspouts. *See "Reducing Moisture Problems" on page 33.*
- ✓ Remove obstacles and debris from the basement.
- ✓ Repair structural cracks in foundation walls.
- ✓ Install a drainage system with a sump and outdoor drainage as appropriate to solve major moisture problems.

Basement wall insulation is often installed ineffectively because of the installers' incomplete understanding about moisture problems.

**Frame-wall method:** Fiberglass batts insulate this basement wall. One-inch rigid foam serves as a thermal break and air seal behind the frame wall. Exterior water drainage must be effective to prevent moisture problems in the basement.



## Frame-Wall Insulation

The most common (although not the best) way to insulate basement walls, or any masonry wall, is to build a framed wall against the masonry wall and fill the wall with fiberglass batts. The frame wall is then covered with drywall.

Unfaced batts are the best choice of fiberglass insulation since they contain no vapor barrier to trap moisture. Moisture may escape from the wall in either direction: from outdoors in or indoors out.

With a framed wall, the installer often neglects to seal in areas where the wall is discontinuous, such as a mechanical room. Any area, such as an unfinished wall, open rim-joint area, or un-sheeted ceiling, constitutes a very large air leak around the insulated wall. Avoid this problem by doing these procedures.

- ✓ Insulate the rim joist and air seal it.
- ✓ Build the frame walls.
- ✓ Wall off the entire basement. If a mechanical room or other area won't be insulated, install an airtight block at the wall's edge to prevent basement air from circulating behind the insulated wall.
- ✓ Don't install a vapor barrier on the interior face of the new basement wall unless you use rigid foam. The new wall assembly must be able to dry toward the indoors or to the outdoors.
- ✓ Install drywall in an airtight manner on the walls and ceiling by applying sealant to the framing lumber around the sheet's perimeter.



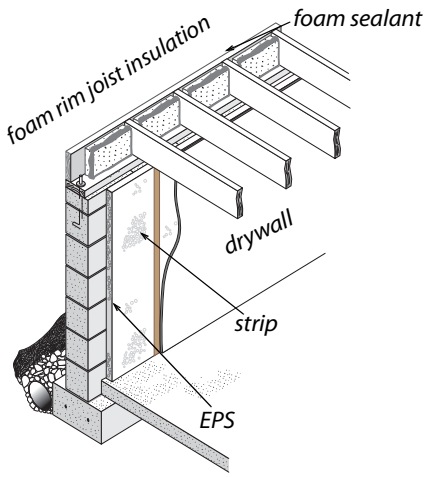

**2-inch foam board with plywood strips:** Installers fasten foam to the foundation wall using built-in strips. They then attach the drywall to the strips in the foam.

## Stripped-Foam Basement Insulation

Polystyrene foam is an excellent choice for insulating smooth basement walls.

You can order either expanded polystyrene or extruded polystyrene equipped with grooves for fastening strips, spaced apart on 16-inch or 24-inch centers. Stripped foam sheets may be the easiest and most satisfactory way to insulate below-grade basement walls. Do these procedures to install 2-inch stripped foam on a foundation wall.

- ✓ Apply walnut-sized globs of adhesive to the back of the sheet on one-foot centers. Use a foam-compatible adhesive and follow the instructions on the container.
- ✓ Install at least two concrete screws or two powder-driven nails in each strip, 24 inches from the bottom and top.



**Installing stripped foam:** Installers glue and screw the foam sheets to the masonry wall and concrete slab. Then they glue drywall to the foam and screw the drywall to the strips.

- ✓ Wherever an electrical box is needed, install it between two sheets if possible because it's easier to run the wire between sheets than toward the center of a sheet. Install an electrical box backed by a piece of treated wood that sets the box out from the foam a half inch to make the box flush with the surface of the drywall. Use construction adhesive and a concrete screw to fasten the box in place.
- ✓ Leave a half-inch gap at the bottom of the polystyrene sheets to run wire. Run the wire along the floor and up into the boxes. If flooding is a possibility, run the wire at the ceiling and down into boxes on the wall.
- ✓ Seal the bottom gap and other gaps in the foam sheeting with one-part foam.
- ✓ Glue the drywall using the same adhesive and pattern. Screw the drywall to each wooden strip with one-inch drywall screws.

## Exterior Foam Foundation Insulation

If installed at the exterior, as during new construction, use durable water-resistant insulation such as blue or pink extruded polystyrene or high-density (2 pcf) expanded polystyrene. For portions that are exposed above ground level and six inches below ground, you'll need to provide mechanical and moisture

protection such as sheet metal or fiberglass panels. For areas more than 6 inches below grade, there are asphalt-based sealants for the foam that you apply with a paint roller.

*See also "Insulated Wall Sheathing" on page 199.*



**EPS foundation insulation:**  
Installers glue masonry-faced EPS-foam sheets to the block wall.

## 6.6 SWS ALIGNMENT

<b>Field Guide Topic</b>	<b>SWS Detail</b>
6: Floors and Foundations - Pg. 205	3.0104 Foundation Spaces 4.03 Floors
6.1: Thermal-Boundary Decisions: Floor or Foundation - Pg. 205	4.03 Floors 3 Air Sealing 3.0101 General Air Sealing 3.0102 Specific Air Sealing 3.0104 Foundation Spaces
6.2: Air Sealing Foundations and Floors - Pg. 208	3 Air Sealing 3.0101 General Air Sealing 3.0102 Specific Air Sealing 3.0104 Foundation Spaces

Field Guide Topic	SWS Detail
6.2.1: Garages Underneath Living Areas - Pg. 209	3.0105.1 Isolating Garage From Living Space 3.0102.3 Sealing Tongue and Groove Surfaces 3.0102.2 Sealing High-Temperature Devices 3.0102.1 Sealing Non-Insulation Contact (IC) Recessed Light
6.2.2: Plumbing Penetrations - Pg. 209	3.0101.1 Air Sealing Holes 3.0104.1 Closed Crawlspace Air Sealing 3.0104.3 Slab Foundation Sealing 3.0104.4 Covers for Intentional Slab Penetrations
6.2.3: Stairways to Unconditioned Areas - Pg. 210	3.0101.1 Air Sealing Holes
6.2.4: Incomplete Finished Basements - Pg. 213	3.0101.1 Air Sealing Holes 4.0402.4 Basements - Without Groundwater Leakage 4.0402.5 Basements - With Groundwater Leakage
6.2.5: Cantilevered Floors - Pg. 214	4.0301.6 Cantilever Floor Joisted Cavities Batt Insulation 3.0101.1 Air Sealing Holes 3.0102.3 Sealing Tongue and Groove Surfaces 4.0302 Exposed Floors; 4.0302.1 Batt Insulation With Rigid Barrier 4.0302.3 Dense Pack with Rigid Barrier
6.3: Preparing for Foundation or Floor Insulation - Pg. 215	3 Air Sealing 4.0401 Rim/Band Joist

<b>Field Guide Topic</b>	<b>SWS Detail</b>
6.3.1: Rim-Joist Insulation and Air-Sealing - Pg. 215	3 Air Sealing 4.0401.2 Batt Insulation; 4.0401.3 Rigid Insulation
6.4: Installing Floor Insulation - Pg. 216	4.03 Floors 4.0301 Accessible Floors 4.0302 Exposed Floors 3.0102.2 Sealing High-Temperature Devices
6.4.1: Blowing Floor Insulation - Pg. 217	4.0301.2 Loose Fill With Netting/ Fabric in Joisted Cavities 4.0301.3 Loose Fill in Joisted Cavities With Rigid Barrier 4.0301.4 Dense Pack in Joisted Cavities With Rigid Barrier 4.0301.8 Non-Joisted Floors Rigid Foam
6.4.2: Installing Fiberglass Batt Floor Insulation - Pg. 219	4.0301.1 Batt Insulation in Joisted Cavities 4.0301.7 Non-Joisted Floors Batt Insulation
6.5: Foundation Wall Insulation - Pg. 222	3.0104.1 Closed Crawlspace Air Sealing 4.0402.1 Closed Crawlspace - Non-Foam Insulation 4.0402.2 Closed Crawlspace - Rigid Foam Insulation
6.5.2: Basement Wall Insulation - Pg. 225	4.0402.4 Basements - Without Groundwater Leakage 4.0402.5 Basements - With Groundwater Leakage



# CHAPTER 7: WINDOWS AND DOORS

*SWS Detail: 3.0201 Windows; 3.0202 Doors*

This chapter presents specifications and procedures for improving the airtightness and thermal resistance of windows and doors.

Use lead-safe weatherization methods for all tasks relating to window and door weatherization, repair, and replacement. [See "Lead-Safe Procedures" on page 50.](#)

Use low-VOC sealants when installing sealants indoors in all window and door work.

## 7.1 STORM WINDOWS

A storm window is an additional window installed outside or inside the primary window.

### 7.1.1 Exterior Aluminum Storm Windows

*SWS Detail: 3.0201.7 Exterior Fixed Storm Window Installation; 3.0201.8 Exterior Operable Storm Window Installation*

Exterior storm windows can save energy and preserve old worn primary windows from destructive weathering. You can attach exterior operable storm windows to the blind stop or exterior window casing of a double-hung window. Or, attach a fixed storm to any flat surface of a window frame or sash if the window is fixed or if a movable sash can support the extra weight.

Metal exterior storm windows are the best choice if they are well designed and installed properly.

- Choose operable storm windows to install on operable windows. Choose fixed storm windows to install on fixed

windows or on sashes that open along with the movable primary window.

- If operable, make sure that the storm window opens and closes to allow the maximum amount of ventilation and egress area.
- Measure the storm-window dimensions according to where you'll attach the storm: blind stop, window casing, or sash.
- Storm-window frames should have sturdy corners so they don't rack out-of-square during transport and installation.
- Sashes must fit tightly in their frames.
- The gasket sealing the glass should surround the glass's edge.
- Consider selecting a hard-coat low-e glass for the storm window, which should face the primary window to protect the low-e coating.
- The storm window should be sized accurately and should fit tightly in the opening.
- The storm window's sashes should be removable from indoors for cleaning.



**Aluminum exterior storm windows:** They protect the primary window and add about an R-1 to the window assembly.

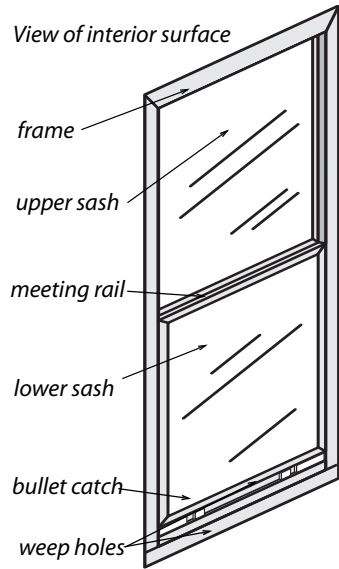

## Installation of Exterior Storm Windows

Follow these guidelines when installing storm windows.

- ✓ Seal storm windows around the frame at time of installation with sealant tape or caulk.
- ✓ Don't allow the tape or caulk to interfere with the weep holes at the bottom of the frame. If weep holes aren't manufactured into new storm window, drill weep holes or leave at least 2 two-inch spaces in sealant to allow water on the sill to escape.
- ✓ Don't allow storm windows to restrict emergency egress or ventilation through movable windows.

*See also "Mobile-home double window" on page 531.*

### 7.1.2 Interior Storm Windows

*SWS Detail: 3.0201.5 Interior Fixed Storm Window Installation; 3.0201.6 Interior Operable Storm Window Installation*

Interior storm windows are usually more airtight than exterior storm windows because they must be airtight to avoid condensation and icing on the primary window during winter. Interior storm windows are usually a metal or plastic frame enclosing some type of plastic glazing.

Consider these specifications when selecting interior storm windows.

- Don't install fixed interior storm windows on egress windows.
- Interior storm windows should have an airtight edge seal to prevent warm moist air from passing by the interior storm window and condensing or icing the interior of the glass on the primary window.
- Interior storm windows should be easily removable for storage.
- The home should have a safe place to store the storm windows seasonally.
- Consider using low-e glass or plastic for glazing to increase thermal resistance.

## 7.2 WINDOW REPAIR AND AIR LEAKAGE REDUCTION

*SWS Detail: 3.0201.1 Window Air Sealing; 3.0201.2 Window Sash Replacement; 3.0201.3 Window Sill Replacement; 3.0201.4 Glass Replacement*

With the exception of broken glass or missing window panes, windows aren't often the major source of air leakage in an existing home.

Window weatherstripping may solve comfort problems around windows, even though it may not be cost-effective. Avoid expensive or time-consuming window repair measures that are implemented to solve minor comfort complaints if the weatherization budget is limited.

## 7.2.1 Double-Hung Window Weatherization

Re-glazing window sashes in a quality manner is time consuming. This task is best accomplished as part of a comprehensive window rehabilitation project. Re-glazing wood windows may not be a durable repair without thorough scraping, priming, and painting. Use lead-safe work practices when working on windows. *“Lead-Safe Procedures” on page 50*

Repair measures may include the following.

- ✓ Replace missing or broken glass. Use glazing compound and glazier points when replacing glass in old windows.
- ✓ Caulk the window frame where appropriate to prevent air leakage, condensation, and rain leakage. Use sealants with adhesion and joint-movement characteristics appropriate for both the window frame and the building materials surrounding the window.
- ✓ Replace missing or severely deteriorated window frame components.
- ✓ Fill damaged wood with epoxy, before priming and painting.
- ✓ Adjust window stops if gaps exist between the stop and jamb. Ensure that the window operates smoothly following adjustment.
- ✓ Weatherstrip large gaps between the sash and the sill or stops. Weatherstrip the meeting rails if needed.
- ✓ Replace or repair missing or non-functional top and side sash locks, hinges, or other hardware if this significantly reduces air leakage.

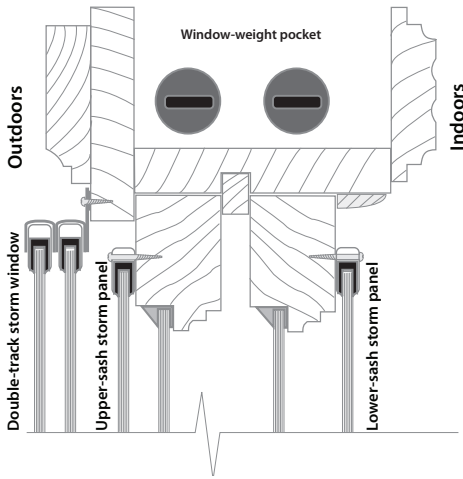

**Optimized double-hung window:** An exterior aluminum storm window plus storm window panels on the window sashes create triple glazing in this double-hung window.

## 7.2.2 Weatherstripping Double-Hung Windows

### *SWS Detail: 3.0201.1 Window Air Sealing*

Window weatherstripping is mainly a comfort retrofit and not a high weatherization priority.

Paint is the primary obstacle when weatherstripping double-hung windows. Often the upper sash has slipped down, and is locked in place by layers of paint, producing a leaking gap between the meeting rails of the upper and lower sashes.

- ✓ To make the meeting rails meet again, either break the paint seal and push the upper sash up, or cut the bottom of the lower sash off to bring it down.

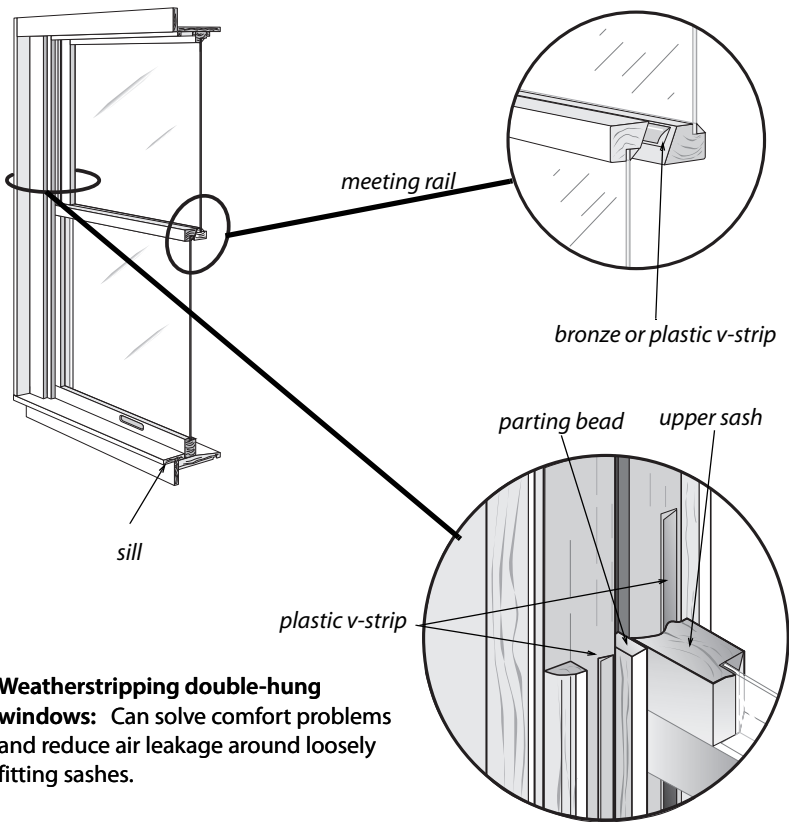

**Weatherstripping double-hung windows:** Can solve comfort problems and reduce air leakage around loosely fitting sashes.

- ✓ To lift the upper sash, cut the paint around its inside and outside perimeter. Use leverage or a small hydraulic jack to lift the sash. Jack only at the corners of the sash. Lifting in the middle can break the glass.
- ✓ Block, screw, or nail the repositioned upper sash into place.
- ✓ To weatherstrip the window, remove the lower sash. Cut the paint where the window stop meets the jamb so the paint doesn't pop off in large flakes as you pry the stop off. Removing a stop is sufficient to remove the bottom sash.
- ✓ Scrape excess paint from the sashes and the window sill.

- ✓ Apply vinyl V-strip to the sides of the jambs where they meet the window sash frame.
- ✓ Apply bronze V-strip to the meeting rail on the top sash where it meets the bottom part of the upper sash. The point of the bronze V goes skyward.
- ✓ Apply bronze V-strip to the bottom part of the lower sash where it meets the sill. The point of the bronze v goes outward.
- ✓ The weatherstripping is caulked on its back side and stapled in place, as shown in the illustration above.

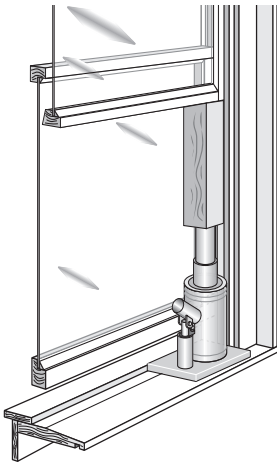

**Lifting an upper window sash:**  
 First cut paint away from around the sash inside and outside. Then lift with leverage or a jack.

## 7.3 WINDOW REPLACEMENT SPECIFICATIONS

### *SWS Detail: 3.0201.9 Window Replacement*

The purpose of these specifications is to guide the selection and installation of replacement windows. Improper window installation can cause water leakage, air leakage, and noise leakage.

Existing window openings may have moisture damage and air leakage. Repair these conditions before or during window replacement.

Included here are specifications for two special window safety considerations.

1. Windows in high risk areas, such as around doors and walkways, must have safety glass.
2. Some bedroom windows function as a fire escape (egress). Recognize and accommodate this egress function.

### 7.3.1 Window Energy Specifications

#### *SWS Detail: 3.0201.9 Window Replacement*

Installing new windows incurs a large labor expense so they should be as energy-efficient as budget allows.

1. Select windows that meet the SHGC, U-factor, and air leakage requirements of the work order.
2. Replacement windows must have a U-factor and Solar Heat Gain Coefficient (SHGC) less than or equal to the requirements on the work order and State-and-local standards.
3. Replacement windows facing east or west in air conditioned homes should have a solar heat-gain coefficient (SHGC) that is equal to or less than what is required by the work order and State standards. Lower is better in warm climates.

	<b>ACME Window Company</b> <b>EnerSaver 2010</b> Vinyl Frame Double Glazing - Argon Fill - Low E Horizontal Sliding Window	
	Energy Performance Ratings	
U-Factor (US/I-P) <b>0.32</b>	Solar Heat Gain Coefficient <b>0.40</b>	
Additional Performance Ratings		
Visible Transmittance <b>0.54</b>	Air Leakage (US/I-P) <b>0.3</b>	
Condensation <b>0.51</b>		
<small>Manufacturer stipulates that these ratings conform to applicable NFRC procedures for determining whole product energy performance. NFRC ratings are determined for a fixed set of environmental conditions and specific product sizes. NFRC does not recommend any product and does not warrant the suitability of any product size. Contact the manufacturer for other performance information.  <a href="http://www.nfrc.org">www.nfrc.org</a> </small>		

Example NFRC label: The key selection criteria for window shopping is displayed on the NFRC label.

### 7.3.2 Removing Old Windows

Remove existing windows without damaging the home’s interior finish, siding, exterior trim, or the water-resistive barrier (WRB) if possible.

1. Protect the interior of the home from construction debris. *See "Lead-Safe Procedures" on page 50.*
2. Remove window sashes, jambs, or siding, depending on the window-replacement method chosen.
3. Repair moisture damage to the rough opening before installing the new window.

### 7.3.3 Installing Replacement Windows

*SWS Detail: 3.0201.9 Window Replacement*

The most important considerations for installing new windows are that the window installation is watertight and airtight.



Water leakage deteriorates building components around the window. To prevent water leakage in frame buildings, the window must be integrated, if possible, into the home's water resistive barrier (WRB).



**Window-frame types:** Order the correct window-frame type for the method of window installation you plan to use.

### 7.3.4 Replacing Nailing-Fin Windows

Install replacement windows with nailing fins in the rough opening after removing the existing window frame and exterior trim. Fasten the nailing fins directly to the house's sheathing or framing, but support the window's weight on the sill with or without shims before fastening the window to the building.

#### Water-Resistive Barrier (WRB)

Designers and builders assume that some rain water penetrates through the siding. The WRB is the building's last defense against water. House wrap and asphalt felt are the most common WRBs. Window replacements that expose the home's WRB must incorporate the WRB in the window installation. Install a sill pan below the window and flashing on the side fins. Use flashing to connect the window opening to the WRB so water that penetrates the siding, trim, or window exits the building by way of the WRB.

Windows are exposed to wind and rain. Install replacement windows so water that penetrates the siding or trim drains to the outdoors. If water leaks underneath the existing WRB or the new flashing, the water eventually damages the building. With proper flashing, the fins and flashing create a drainage system that drains water to the outdoors rather than relying on caulked

siding and trim to prevent rain water from penetrating the building's surface.

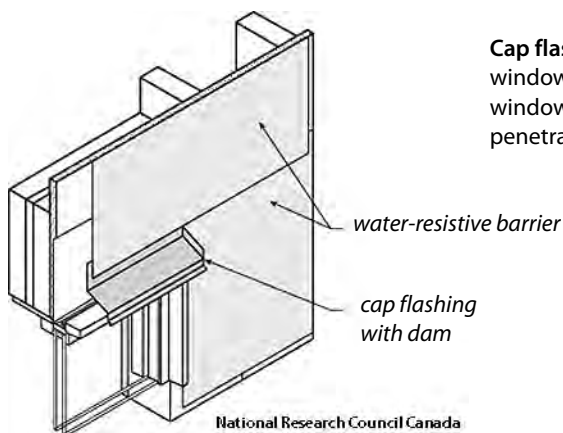

**Cap flashing:** Cap flashing at the window's head protects the window from rain water penetration.

Follow these steps to install a nailing-fin window in the rough opening.

1. At the sill, insert the flashing underneath the existing siding, over top of existing building paper, and under the bottom nailing fin of the window.
2. Use flat shims to provide a level surface and support under the vertical structural members of the new window frame. Don't allow the fins to support the window's weight.
3. Use fasteners with heads wide enough in diameter to span the holes or slots in the window fin.
4. Avoid over-driving the fasteners or otherwise deforming the window fin.
5. Flash the window around its perimeter with 15-pound felt, house wrap, or a peel-and-stick membrane.
  - a. Flashing procedures may vary. However, always install flashing materials to overlap like shingles.

- b. Insert the new building paper or flashing underneath the existing siding and underneath existing building paper on the sides and top of the window opening.
6. Windows that are exposed to wind-driven rain or without overhangs above them or without WRB integration should have a rigid cap flashing (also called head flashing) to prevent rainwater from draining onto the window. The cap flashing should divert water away from vertical joints bordering the window with an overhang or dam.
7. Tuck the cap flashing up behind the WRB or exterior siding. Metal cap flashing must have downward bending lip of at least  $\frac{1}{4}$  inch on the front and ends.
8. Fill gaps between the new window and existing frame with low-expanding foam.
9. Thoroughly caulk all filler and trim pieces surrounding the replacement window.

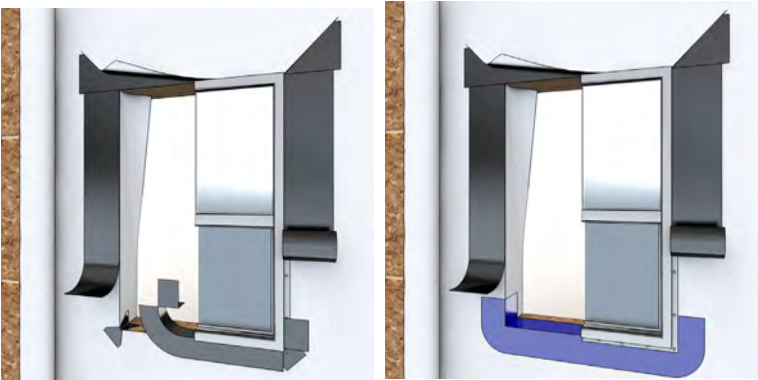

**Flashing nail-fin windows:** Installers place the window on and over the sill flashing. The side and top flashing cover the fastening fin. The two methods shown here are: using a flexible membrane (right) and using a bow-tie-shaped flashing to underlay the corners when using a standard membrane.

### 7.3.5 Block-Frame or Finless Windows

Contractors install windows using a block-frame or finless installation when they can't remove the existing window frame or in a masonry window opening. Block-frame windows rely on caulk or rigid flashing to create a weatherproof seal around the window perimeter. Take care when installing caulk so that it is durable and effective for as long as possible.

Comply with the following requirements when installing block-frame or finless windows.

1. Block-frame or finless windows may require a sufficiently wide gap between the new window and the existing window frame or masonry opening to allow for the following.
  - a. Allowing for a slightly out-of-square opening.
  - b. Leveling the window.
  - c. Insulating the gap with foam.
2. Access the window-weight cavities, remove the weights, and fill the cavities with insulation, and seal the cavities.
3. Protect the existing sill with a metal or plastic sill pan or rigid sill flashing if necessary for drainage and to protect the existing sill that protrudes from the exterior wall. Or, install a new sill as part of the window replacement.
4. Support block-frame or finless windows under their main vertical supports with shims that level the window.
  - a. Use flat shims for support if the sill surface is flat.
  - b. Use tapered shims or a sill angle for support if the sill surface is sloping.
5. Windows without fins must be secured to the rough opening within 4 inches of each side corner and a mini-

imum 12 inches on center along the remainder of the frame with one of these fastening methods.

- a. Screws fastened through the window frame. Use screws that are designed for fastening block-frame windows if available.
  - b. Jamb clips or plates that are fastened first to the window and then to the opening in separate steps.
6. Fill gaps between the new window and existing frame with low-expanding foam.
7. If possible, flash block-frame windows between the opening and the replacement-window frame and extend the flashing out far enough to slip under or into the siding.
- a. Tuck the flashing up behind the exterior siding at least 1 inch.
  - b. Sill and cap flashing should have a downward bending lip of at least  $\frac{1}{4}$  inch on the front that sheds water away from the building.

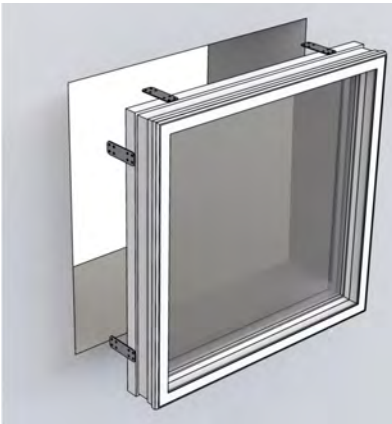

**Block frame window installation:** Block-frame windows don't have a fin. Installers use plates or screws to fasten the window to its opening.

### 7.3.6 Flush-Fin Window Replacement

Flush-frame windows are replacement windows that fasten to the window opening and mount directly over the flat siding surrounding the window opening. Replace windows in stucco walls using windows with flush fins, also called stucco fins, that have no nail holes. Flush-fin windows work well for any window opening with a flat water-resistant finished surface surrounding the window opening.

This flush-fin window-replacement technique is similar to block-frame window installation.

1. Support the replacement window on the existing sill with one of the following materials.
  - a. A flat or tapered continuous wood support.
  - b. Flat shims under the window's main vertical supports.
  - c. Tapered shims under the window's main vertical supports if the sill is sloping.
2. Apply a sealant that remains flexible to the back of the flush fin of the replacement window in order to seal it to the surface of the exterior wall. Interrupt the caulking at the bottom fin for one inch on each side of the window's weep holes.
3. Fasten the flush-fin window to the window opening by driving screws through the replacement window's frame.



**Flush frame window:** Flush frame windows have the fin at the exterior surface of the window and seal to a flat exterior surface like stucco.

## 7.4 WINDOW SAFETY SPECIFICATIONS

Windows have special requirements for breakage-resistance in areas that are prone to glass breakage, and for fire escape in bedrooms.

### 7.4.1 Windows Requiring Safety Glass

Safety glass is required in locations that the IRC 2012 considers hazardous to the building's occupants. Safety glass must be either laminated glass, tempered glass, organic coated glass, or annealed glass bearing a permanent label identifying it as safety glass, manufactured in compliance with CPSC 16 CFR 1201 or ANSI Z97.1.

Instead of safety glazing, glazed panels may have a protective bar installed on the accessible sides of the glazing 34 to 38 inches above the floor. The bar must be capable of withstanding a horizontal load of 50 pounds per linear foot without contacting the glass and be a minimum of 1<sup>1</sup>/<sub>2</sub> inches in diameter.

Safety glass or a protective bar is required in the following hazardous locations.

- ✓ Glazing wider than 3 inches in entrance doors.
- ✓ Glazing in fixed and sliding panels of sliding doors and panels in swinging doors.

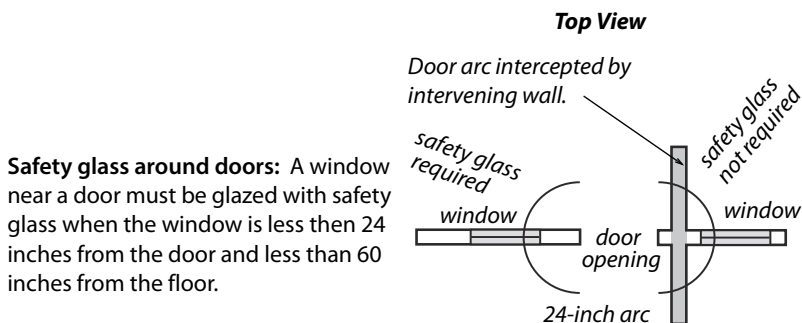

- ✓ Glazing in fixed or operable panels adjacent to a door where the nearest exposed edge of the glazing is within a 24-inch arc of the vertical edge of the door in a closed position and where the bottom edge of the glazing is less than 60-inches above the floor or walking surface. Exception: If there is an intervening wall or permanent barrier between the door and the glazing, safety glass isn't required.
- ✓ Glazing adjacent to the landing of the bottom of a stairway where the glazing is less than 36 inches above the landing and within 60 inches horizontally of the bottom tread.
- ✓ Glazing with a bottom exposed edge that is less than 36 inches above the walkway surface of stairways, landings, and ramps.
- ✓ Glazing in any portion of a building wall enclosing showers, hot tubs, whirlpools, saunas, steam rooms, and bathtubs where the bottom exposed edge is less than 5 feet above a standing surface or drain inlet.

Glazing in an individual fixed or operable panel that meets all of the following conditions must also have safety glass:



1. An exposed area of an individual pane greater than 9 square feet, and
2. An exposed bottom edge less than 18 inches above the floor.
3. An exposed top edge greater than 36 inches above the floor.
4. One or more walkways within 36 inches horizontally of the glazing.

## 7.4.2 Fire Egress Windows

Windows are the designated fire escape for bedrooms and should offer a minimum opening for a person's escape. If the window installation requires a code-approved egress window, observe these specifications.

1. Each bedroom must have one egress window.
2. Egress windows must provide an opening that is at least 20 inches wide and at least 24 inches high.
3. Egress windows must provide an opening with a clear area of at least 5.7 square feet except for below-grade windows, which must have at least 5.0 square feet of opening.
4. The finished sill of the egress window must be no higher off the floor than 44 inches.
5. You may install security bars, screens, or covers over egress windows as long as these security devices are easily removable from indoors.

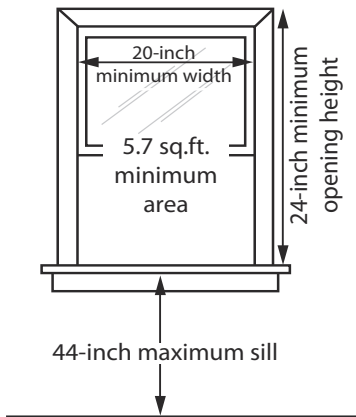

**Egress windows:** Windows for fire escape must be large enough and a convenient distance from the floor.

## 7.5 WINDOW SHADING TREATMENTS

### *SWS Detail: 5.0401.1 Indigenous Shading*

Single-pane, unshaded windows transmit about 85% of the solar heat striking them. This high transmittance accounts for up to 40% of the heat a building accumulates.

Consider these factors when deciding which windows to shade.

- **Direction the windows face.** South windows transmit the most solar heat. West windows contribute solar heat in the afternoon, just when summer comfort is most difficult to provide. East windows begin heating the home early in the morning, causing more hours of potential discomfort.
- **Location of natural shade from trees, overhangs, and other objects.** If windows are already shaded by trees, nearby buildings, or large overhangs, additional shading is unnecessary.
- **Total surface area of windows.** Shading devices for larger windows are generally more cost-effective than for smaller windows.

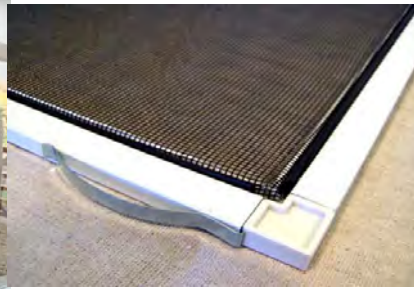

**Solar screens:** Intercept and absorb solar heat before it enters the building. Building a solar screen is much like building an insect screen.

**Reflective or Low-e window films:** Manufacturers provide step-by-step instructions for installing their products.

## 7.5.1 Solar Screens

Solar screens are often the least expensive window-shading option to retain a view through the window. Installers stretch the solar-screen fabric over an aluminum frame much like assembling an insect screen. The fabric absorbs and dissipates 65% to 70% of the solar heat before it enters the home.

Install solar screens on the exterior of a window to be effective at keeping solar radiation from penetrating the window. Therefore, they're not practical for outwardly opening windows, such as awning or casement windows, unless attached to the movable sash's exterior.

## 7.5.2 Solar Window Films

Metalized plastic window films (similar to those applied to automotive windows) can block 50% to 75% of the solar heat on single-pane glass. Unlike sun screens, reflective window films don't obstruct the operation of any kind of window.

A microscopic layer of metal on the film reflects solar radiation. Installed on the interior side of single-pane glass, reflective win-

dow films reflect solar heat, decrease glare, and reduce fading of fabrics and paint. The most effective films look like a mirror when viewed from outdoors during the daytime. Tinted transparent films that merely darken the glass aren't as effective in blocking the sun as metalized films.

Installing reflective window film requires some skill and experience. Professionals stress thorough preparation and careful installation to an absolutely dirt-free glass surface and surrounding sash.

## 7.6 DOOR REPAIR AND WEATHERSTRIP

### *SWS Detail: 3.0202.1 Door Air Sealing*

Door operation affects building energy-efficiency, security, and durability, so doors are often an important weatherization priority. A leaky door may be an important comfort problem, and weatherstripping the door can be a high-value energy conservation measure.

Only weatherstrip doors that operate well, as described below. Perform all door adjustment and repair in a lead-safe manner. *See "Lead-Safe Procedures" on page 50.*

### 7.6.1 Evaluating Exterior Doors

Before weatherstripping a door, evaluate the door's operation.

- Does the door bind or scrape against its jambs, indicating a need for hinge adjustment, cutting, planing, or sanding?
- Does the door close and latch tightly and evenly against its stops or is there an uneven space between the door and stop when the door latches?
- Can you move the latched door back and forth against its stops, indicating a need for adjustment of the stop or strike plate?

- Can you move the open door up and down, indicating loose hinges?

## 7.6.2 Causes of Door Binding

You can adjust binding doors by moving the door within its opening. The clearance between a door and its jamb should be between  $\frac{1}{16}$  and  $\frac{3}{16}$  of an inch (2-to-5 mm).

Be aware that the distance that you move the door to adjust it is small —  $\frac{1}{16}$  inch or 1-to- 2 millimeters. The goal of adjustment is to solve a door-binding problem so that the door closes and latches correctly and that weatherstrip seals air leakage without causing a problem.

Consider these door-operating problems and possible solutions.

### Loose, Sagging, or Misaligned Hinges

The most common door problem is that gravity has pulled the door down and toward the top-latch side corner and inward the bottom hinge-side corner.

- ✓ *The hinge screws are loose.* Tighten the screws on the jamb and door. Add longer screws if necessary. If longer screws penetrate the stud behind the door jamb, those screws can pull the door and its jamb back a little at the top hinge side.
- ✓ *Gravity bent the top-hinge knuckles over time, creating an excessive gap between the top jamb and the top latch side of the door. This made the door's top latch-side corner lean toward the top of the latch-side jamb and bind the door there.* Use an adjustable wrench to bend the hinge knuckles, fastened to the door, very slightly. The hinge screws must be very tight so they don't pull out when you bend the knuckles.
- ✓ *There is excess room on the hinge side and inadequate room on the latch side.* Chisel the hinge mortise deeper to allow the screws to pull the door away from the latch-side jamb.

- ✓ *There is excess room on the latch side and inadequate room on the hinge side.* Shim the hinges outward with cardboard or sheet plastic. Loosen the hinge screws and place the shims between the hinge and jamb, then tighten the screws. If the latch-side gap varies, use shims of varying thickness behind the hinges.
- ✓ *Closing the door creates a spring effect because the door is pulling on the hinge.* Rotate the hinge slightly by shimming so that the hinge sits flat and in the same plane as the door.

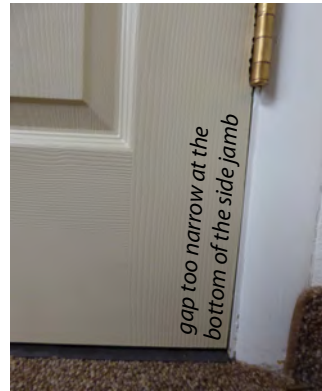
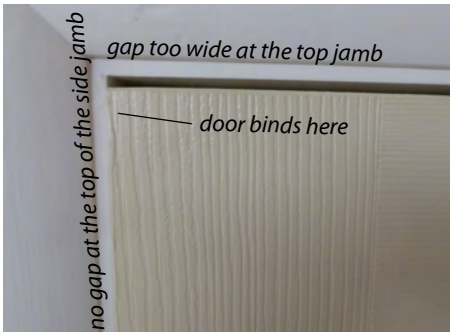

**Symptoms of a sagging door:** Gravity rotated this door to pinch the top jamb side corner and bottom hinge side corner of the door against the side jambs.

## Door-Frame or Structural Problems

1. *The hinge-side door jamb moved slightly toward the latch-side, wracking the door frame slightly out of square and binding the door at the top latch side and the bottom hinge side.*
  - a. Drive long screws through the top hinge or the upper part of the hinge jamb.
  - b. Or, loosen the bottom hinge and the middle hinge if necessary. Install cardboard or plastic shims behind the hinges that move the door up and away from the bottom hinge side jamb and toward the bottom latch side.

2. *The building has settled near the door.*
  - a. Cut, plane, or sand the door so it closes without rubbing or binding against its jambs.
  - b. Use a jack to level the floor if practical — the building has a basement, for example. Devise a way to support the floor in its newly adjusted position.
3. *Temperature and humidity changes swell and shrink the door seasonally. Or, the door is permanently swollen.*
  - a. If the door swells and shrinks, wait until it shrinks and apply oil-based paint or urethane varnish to seal the door and prevent future swelling.
  - b. If the door is permanently swollen, plane and/or sand the door. Or if there is room between the jambs and framing, try to move the jambs outward slightly after removing the casing on one side.
4. *Paint has built up and reduced the door's operating gap.*
  - a. Plane or sand off the excess paint. Planing and sanding are a last resort, so try the previous suggestions first.

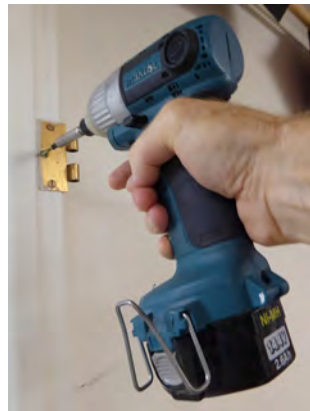

**Solutions for door sagging:** Bend the hinge knuckles slightly, drive a long screw into the hinge, and/or drive another long screw into the jamb above the hinge. Experience will tell you which solution works in each particular case.

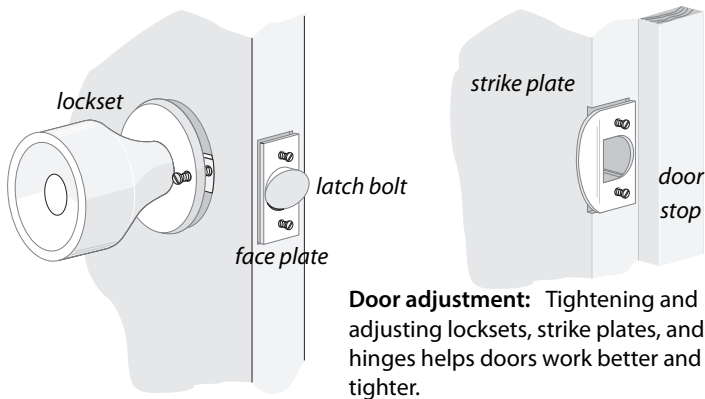

### 7.6.3 Adjusting Door Stops and Latches

Tighten loose door knobs, face plates, and strike plates before concluding that there is a problem with the stops or latches. These steps should precede weatherstripping.

#### Problems with the Door Stop

There are two different types of door stops: the nailed-on type and the integral type. You can move the nailed-on type

If a door won't latch, inspect the door stops, door jambs, hinges, and weatherstripping to see if they're causing the binding.

- ✓ If the door is warped and doesn't fit well against its stops, adjust the stops by moving them against the door if they are nailed-on stops.
- ✓ If the stops are integral to the door jambs, plane them so door closes snugly against its stops.

#### Problems with the Latch

The strike plate is mortised into the latch side of the door frame. The latch bolt seats into a hole in the strike plate and the door jamb under it. Often the latch bolt doesn't seat because of problems with the hinges or the jambs as discussed earlier.



If there's no obvious problem with the stops, hinges, weather-strip, mark the strike plate to evaluate how far you have to move it. Put lipstick or crayon wax on the latch and close the door and then notice the mark on the strike plate. Move the strike plate or use a rotary file to remove some metal from the strike plate, enough to allow the latch bolt to seat itself.

- ✓ Remove the two screws from the strike plate.
- ✓ Move the strike plate enough to seat the latch bolt. Use toothpicks to fill existing screw holes.
- ✓ Consider driving slightly longer screws, if you have to move the strike plate.

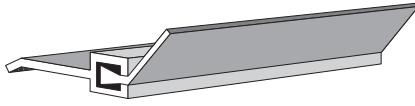

*Vinyl flap weatherstrip is particularly flexible, allowing the door to remain sealed with seasonal movements of the door*



*This Q-Lon weatherstrip inserts into a kerf in the integral door stop of a pre-hung exterior door.*

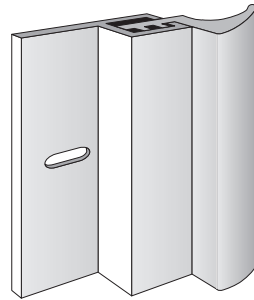
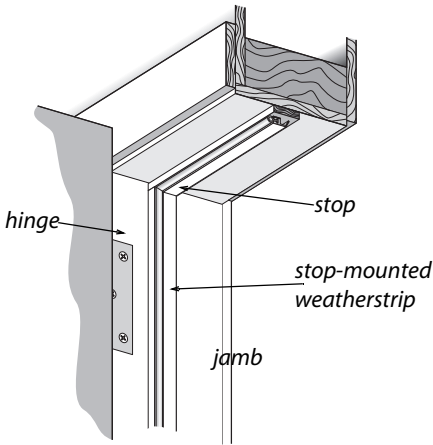

*This Q-Lon weatherstrip installs on an existing door stop.*

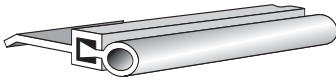

*Silicone bulb weatherstrip is much more flexible than vinyl bulb and therefore seals better.*



*This Q-Lon weatherstrip acts as a replacement door stop.*

**Weatherstripping doors:** The weatherstrips shown should be flexible enough to move with the door seasonally and maintain their seal as the door moves seasonally.

## 7.6.4 Weatherstripping Doors

### *SWS Detail: 3.0202.1 Door Air Sealing*

- ✓ Install weatherstrip only on doors that operate properly as described previously.
- ✓ Consider how much the weatherstrip narrows the width of the door, when weatherstripping a door with a lot of traffic.
- ✓ Ask the client whether they want to locate a foot-wiping rug on the floor, adjacent to the door. Make sure that the threshold is high enough to accommodate the rug.

### Weatherstrip Specifications

- ✓ When possible, consider replacing the existing nailed-on door stop with a door stop that includes the weatherstrip to avoid reducing the existing width of the door.
- ✓ Select a durable and flexible weatherstrip to seal the door's side jambs and head jamb.
- ✓ Seal the threshold and bottom corners of the door with caulk and/or gaskets.

### Installing Weatherstrip

Consider these suggestions when weatherstripping doors.

- ✓ Seal the back of the weatherstrip to prevent air from leaking behind the weatherstrip.
- ✓ Install thresholds and door sweeps, if needed to prevent air leakage at the door bottom. These air seals shouldn't bind the door. Caulk underneath and on both sides of the door seal.
- ✓ Install corner seals to close the gaps at the bottom corners of the door jambs.
- ✓ Seal gaps between the stop and jamb with caulk.

- ✓ Install a door sweep if you don't install a door bottom.
- ✓ The door must operate smoothly after you weatherstrip it.

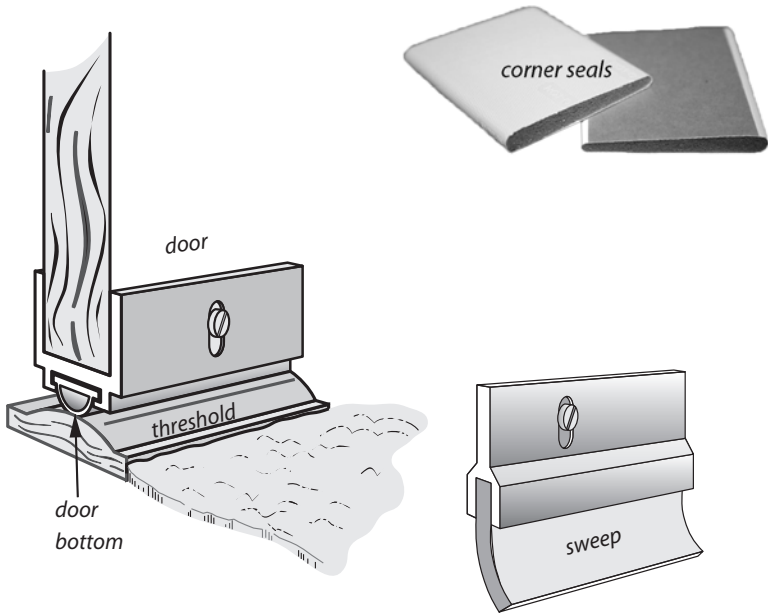

**Weatherstripping at the door bottom:** A threshold and door bottom are the ideal bottom seal for a door. The threshold and door bottom must be adjusted to seal but not bind. Corner seals in the bottom complete a quality door-weatherstripping job.

## 7.7 DOOR REPLACEMENT

### *SWS Detail: 3.0202.2 Door Replacement*

Sometimes you can replace an exterior door for less labor compared to repair and readjustment. The labor just to replace the threshold on an existing pre-hung door is itself very challenging.

Install flashing around doorways according to the specifications in *“Installing Replacement Windows”* on page 242.

You can replace an exterior door, as an efficiency measure, if you can justify the cost under program rules. Use RRP methods to ensure occupants and workers aren't exposed to lead dust during door replacement. *See "Lead-Safe Procedures" on page 50.*

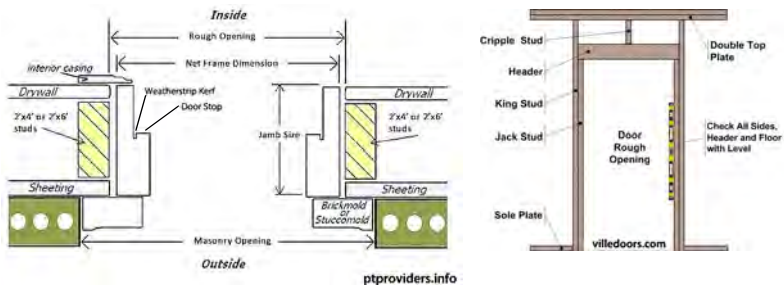

**Door anatomy:** The door and its frame fit into a rough opening. The door jamb matches the wall thickness and attaches to casing on the interior and exterior of the wall.

### 7.7.1 Replacement-Door Standards

Observe the following standards when replacing exterior doors.

- ✓ Select an exterior-grade insulated door-blank or a pre-hung insulated door, preferably without glazing.
- ✓ Choose a foam-insulated door with a U-factor of less than 0.17 (R-value of 6 or greater).
- ✓ Size the door assembly, including the door frame and threshold to be 1½–2 inches narrower and at least ¾ inch shorter than the rough opening.
- ✓ The replacement door must have three hinges and a threshold.
- ✓ If your selected door has glazing, specify an appropriate U-factor and solar heat-gain coefficient appropriate for the climate.
- ✓ Use sealants compatible with fire-rated assemblies to seal door casing, jambs, and thresholds when you replace fire-rated doors in fire-rated assemblies.

## 7.7.2 Replacement-Door Installation

Follow these steps to install a pre-hung replacement door.

1. Remove the existing door casing, the door, and its frame.
2. Remove the old threshold and check the floor underneath the door for level. Check the rough opening for square with a framing square or by measuring the diagonals.
3. Level the floor across the door width and make sure it aligns with the nearby floor.
4. Make sure that the door clears the existing floor with extra room for a foot-wiping rug, if appropriate. This may require the floor, directly under the threshold, to be a little higher than the existing interior floor.
5. Prepare the door's rough opening thoroughly to create a continuous air barrier and water barrier using the air sealing and water sealing procedures specified in *“Window Replacement Specifications” on page 240*.
6. If the door frame has no exterior casing, fasten two pieces of 1-inch lumber 4 inches longer than the frame is wide horizontally to the door jambs across the new door frame. These are temporary braces to hold the door flush with the interior or exterior finish wall material while you fasten the door to the jambs.
7. Install a bead of caulk on the floor where the exterior edge of the threshold sits.
8. Place the door in the opening, and level the hinge side using three sets of 2 opposing wedges behind each hinge.
9. Drive one or more long screws through the top hinge, jamb, and wedges into the framing lumber. Then fasten

through the hinge-side jamb and wedges near the other two hinges.

10. Check the frame for square with a framing square or by measuring the door frame's diagonals. Move the frame slightly if necessary to make it square.
11. Install wedges and screws at the strike plate and then at the top and bottom of the lock side of the door frame.
12. Read the directions and adjust the new threshold for proper fit against the new door's weatherstripped bottom.
13. Install interior casing and exterior casing if the door didn't come equipped with casing.

## 7.8 SWS ALIGNMENT

<b>Field Guide Topic</b>	<b>SWS Detail</b>
7: Windows and Doors - Pg. 233	3.0201 Windows 3.0202 Doors
7.1.1: Exterior Aluminum Storm Windows - Pg. 233	3.0201.7 Exterior Fixed Storm Window Installation 3.0201.8 Exterior Operable Storm Window Installation
7.1.2: Interior Storm Windows - Pg. 235	3.0201.5 Interior Fixed Storm Window Installation 3.0201.6 Interior Operable Storm Window Installation
7.2: Window Repair and Air Leakage Reduction - Pg. 236	3.0201.1 Window Air Sealing 3.0201.2 Window Sash Replacement 3.0201.3 Window Sill Replacement 3.0201.4 Glass Replacement
7.2.2: Weatherstripping Double-Hung Windows - Pg. 238	3.0201.1 Window Air Sealing

<b>Field Guide Topic</b>	<b>SWS Detail</b>
7.3: Window Replacement Specifications - Pg. 240	3.0201.9 Window Replacement
7.3.3: Installing Replacement Windows - Pg. 242	3.0201.9 Window Replacement
7.5: Window Shading Treatments - Pg. 252	5.0401.1 Indigenous Shading
7.6: Door Repair and Weatherstrip - Pg. 254	3.0202.1 Door Air Sealing
7.6.4: Weatherstripping Doors - Pg. 261	3.0202.1 Door Air Sealing
7.7: Door Replacement - Pg. 262	3.0202.2 Door Replacement



## **CHAPTER 8: HEATING AND COOLING SYSTEMS**

This chapter discusses safety and energy-efficiency improvements to heating and cooling systems. Here are the chapter's main sections.

1. Essential combustion-safety testing
2. Heating-system replacement
3. Servicing gas and oil heating systems
4. Combustion venting
5. Heating distribution systems
6. Air-conditioning systems

Weatherization agencies must perform a combustion-safety evaluation as part of each weatherization work scope. This evaluation is the chapter's first topic. The chapter's other topics are procedures and requirements related to cost-effective ECMs, such as tune-ups and equipment replacement.

Qualified heating technicians should perform the installations, adjustments, and maintenance described in this chapter.

**Important Note:** Use manufacturer's specifications and instructions whenever they are available. Many of the specifications in this chapter assume that the manufacturer's instructions aren't available. We offer numbers and other specific guidance that experts and reviewers consider correct. In general, the ***authority having jurisdiction (AHJ)*** is the most important source of guidance. For example: your city or county building department, fire department, or mechanical inspector. Weatherization providers have the ultimate responsibility for compliance with all relevant codes, standards, and requirements. See [WPN 17-7 A](#) for more information on Code Compliance and Inspection Requirements.

## Building Performance Institute (BPI)

BPI requires combustion-safety testing and worst-case depressurization testing for all buildings retrofitted under BPI Standard 1200. See [“Combustion-Safety Evaluation” on page 271](#).

## NFPA Codes

The [National Fire Protection Association \(NFPA\)](#) publishes codes and standards used for HVAC installation, maintenance and repair.

- IFGC: *International Fuel Gas Code*
- NFPA 54: *The National Fuel Gas Code*
- NFPA 31: *Standard for the Installation of Oil-Burning Equipment*
- NFPA 211: *Standard for Chimneys, Fireplaces, Vents, and Solid-Fuel-Burning Appliances*
- NFPA 70: *National Electrical Code*

## ANSI/ACCA Manuals

The American National Standards Institute (ANSI) and [the Air Conditioning Contractors of America \(ACCA\)](#) together publish authoritative manuals to size and select HVAC equipment, which are for sale on the ACCA website.

- [Standard 4: Maintenance of Residential HVAC Systems](#)
- [Standard 5: Quality Installation Specifications](#)
- Manual J: *Residential Load Calculation*
- Manual D: *Residential Duct Design*
- Manual S: *Residential Equipment Selection*
- Manual N: *Commercial Load Calculation*
- Manual CS: *Commercial Systems Overview*

## ICC Codes

The *International Code Council (ICC)* publishes building codes for residential and commercial buildings, along with codes on energy efficiency and safety.

- IMC-ICC: *International Mechanical Code*
- IRC-ICC: *International Residential Code*
- IBC-ICC: *International Building Code*
- IECC-ICC: *International Energy Conservation Code*

If you find a conflict among the listed codes, local codes, manuals, and manufacturer's specifications, comply with the most specific and stringent requirement among them.

## 8.1 HVAC-SYSTEM COMMISSIONING & EDUCATION

HVAC commissioning is the process of inspecting, testing, a system and educating occupants, landlords, and building operators to achieve the following goals.

### 8.1.1 HVAC-System Commissioning

- ✓ Verify that the HVAC system works as the manufacturer, designer, and installer understand that it should work, based on plans, specifications, and manufacturers' literature.
- ✓ Take appropriate measurements to verify that the HVAC system works safely and efficiently.
- ✓ Verify that the building owner or building operator understand the HVAC system's operation and have the necessary system documentation.
- ✓ Verify that the building owner or building operator understand the procedures and the schedule for routine maintenance.

## Types of Commissioning

There are three (3) types of commissioning.

1. Retro-commissioning, is commissioning implemented on existing HVAC equipment in an existing building.
2. Initial commissioning occurs during installation of a new HVAC system.
3. Re-commissioning is commissioning HVAC systems, that were already commissioned during original HVAC-system installation.

This chapter strives to provide the essential information for commissioning HVAC systems. However, this information isn't a substitute for plans, specifications, and manufacturers' literature that should guide all HVAC installations. Searching for the HVAC system's documentation is an essential first step in retro-commissioning or recommissioning.

### 8.1.2 HVAC-System Education

Homes and multifamily buildings are complex systems of building envelopes and mechanical systems that harbor a variety of hazards. Educate occupants, landlords, and building operators about the health and safety hazards and the improvements that you make to mitigate these hazards.

- ✓ Explain equipment operation and maintenance (O&M).
- ✓ Provide a O&M procedures manuals and manufacturers' equipment specifications. Encourage occupants or staff to store important documents in a safe and obvious location.
- ✓ Instruct occupants or staff to remove combustible materials from near ignition sources.
- ✓ Inform occupants and staff about smoke alarms, carbon monoxide (CO) alarms, and combination alarms, and explain their functioning.

- ✓ For complex mechanical systems in multifamily buildings, provide signs to inform occupants and building operators about operations, maintenance, and emergency procedures.

## 8.2 COMBUSTION-SAFETY EVALUATION

*SWS Detail: 5.0501 Combustion Appliance Zones; 5.0502 Combustion Air; 5.0503 Appliance Venting; 5.0504 Fuel Delivery*

At a minimum, evaluate the combustion safety at the weatherization job's completion.

*See "NFPA Codes" on page 268.*

### 8.2.1 Combustion-Safety Observations

Make the following observations before testing to help you determine the likelihood of carbon monoxide (CO) and spillage problems.

- ✓ Recognize soot near the draft diverter, barometric damper, or burner of a combustion appliance as a sign that the appliance has produced CO and spilled combustion gases.
- ✓ Recognize that rust in a chimney or vent connector may also indicate spillage.
- ✓ Look for irregularities and flaws in the venting system.
- ✓ Specify that workers seal all accessible return-duct leaks attached to combustion furnaces.
- ✓ Verify that the home has a working CO alarm. If the home has no working smoke alarm in addition to no CO alarm, install a combination CO-smoke alarm, or separate CO and smoke alarms.

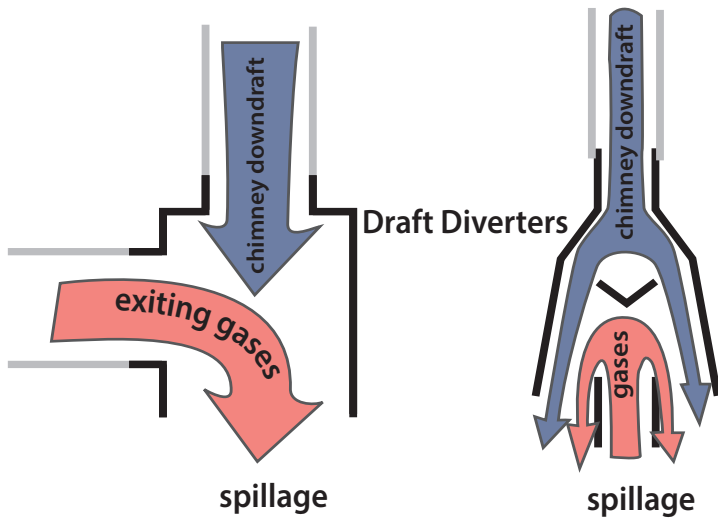

**Draft-diverter spillage:** Look for soot or corrosion near the draft diverter and also near the burner caused by spillage.

## 8.2.2 Leak-Testing Gas Piping

*SWS Detail: 5.0504 Fuel Delivery; 5.0504.1 Natural Gas/Propane Fuel Piping;*

Natural gas and propane piping systems may leak at their joints and fittings. Find gas leaks with an electronic combustible-gas detector, also called a gas sniffer. A gas sniffer finds significant gas leaks if used correctly.

- ✓ Sniff all valves and joints with the gas sniffer.
- ✓ Accurately locate leaks using a noncorrosive bubbling liquid, designed for finding gas leaks.
- ✓ Repair all gas leaks or label them for a gas service person to seal.
- ✓ Replace kinked, cracked, or corroded flexible gas connectors.

- ✓ Replace flexible gas lines manufactured before 1973. The line's manufacture date is stamped on a date ring attached to the flexible gas line or on the body of the hex nut. If a date ring isn't present and you believe the gas line predates 1973, then replace the flexible gas line.

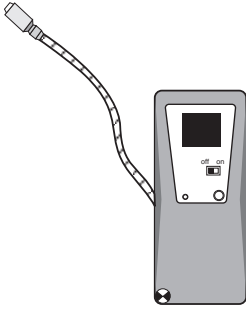

**Gas sniffer:** Use this device to detect the presence of combustible gases around fittings.

## 8.2.3 Carbon Monoxide (CO) Testing

CO testing is essential for evaluating the safety of combustion and venting. Measure CO in the flue gas of every combustion appliance you inspect and service. Measure CO in ambient air in both the home and CAZ as part of inspection and testing of combustion appliances. We strongly recommend using a full-featured electronic combustion analyzer for flue-gas analysis during this essential combustion safety testing. *See “Critical Combustion-Testing Parameters” on page 293.*

### Vent Testing for CO

Testing for CO in the appliance vent is a part of combustion testing that happens under worst-case conditions. BPI has two separate CO limits depending on the type of appliance. If the following CO limits are exceeded in the undiluted combustion byproducts, the appliance fails the CO test under current BPI standards.

- Space heaters and water heaters: 100 ppm as measured or 200 ppm air-free

- Furnaces or boilers: 200 ppm as measured or 400 ppm air-free

## Ambient Air Monitoring for CO

BPI requires monitoring of CO during combustion testing to ensure that CO in the combustion appliance zone (CAZ) doesn't exceed 35 ppm as measured. If ambient CO levels in the combustion zone exceed 35 ppm, stop testing for your own safety. Ventilate the CAZ thoroughly before resuming combustion testing. Investigate indoor CO levels, greater than outdoor ambient levels, to determine their cause. *See "Causes of Carbon Monoxide (CO)" on page 25.*



### **Video: Worst-case CAZ depressurization**

— How to analyze and troubleshoot CAZ depressurization.

## 8.2.4 Worst-Case CAZ Depressurization Testing

CAZ depressurization is the leading cause of backdrafting and flame roll-out in furnaces and water heaters that vent into naturally drafting chimneys and venting systems.

Worst-case vent testing uses the home's exhaust fans, air handler, and chimneys to create worst-case depressurization in the combustion-appliance zone (CAZ). The CAZ is an area containing one or more combustion appliances. During this worst-case testing, you can measure the CAZ pressure difference with reference (WRT) to outdoors and test for spillage.

Worst-case conditions do occur, and venting systems must exhaust combustion byproducts even under these extreme conditions. Worst-case vent testing exposes whether or not the venting system exhausts the combustion gases when the combustion-zone pressure is as negative as you can make it. A digital



manometer is the best tool for accurate and reliable readings of both combustion-zone depressurization and chimney draft.

**Flame roll-out:** A serious fire hazard can occur when the chimney is blocked, when the combustion zone is depressurized, or during extremely cold weather.

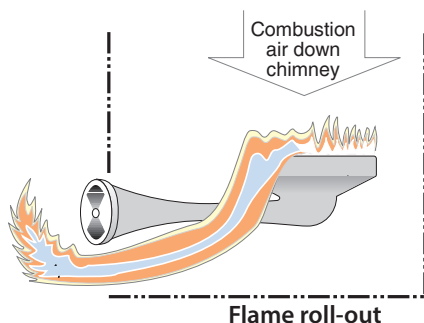

Take all necessary steps to reduce CAZ depressurization and minimize combustion spillage, based on your tests.

### Worst-Case CAZ Depressurization Test

Follow the steps below to find the worst-case depressurization level in the combustion appliance zone (CAZ).

1. Close all exterior doors, windows, and fireplace damper(s). Open all interior doors, including closet doors.
2. Remove furnace filter if it's dirty. Leave the dirty filter out for the test or replace it with a new filter. Be sure the filter slot is covered for the test.
3. Record the baseline pressure of the CAZ with reference to outdoors.
4. Turn on the clothes dryer and exhaust fans. (Clean clothes dryer filter trap)
5. Open doors to negative zones (rooms with exhaust fans), and close doors to positive zones (bedrooms without returns). Use smoke or a manometer to test room pressures if necessary.

6. Open and close the CAZ door. Record the most negative pressure and note CAZ door position.
7. Turn on the furnace air handler. Leave it on if the CAZ pressure goes more negative. If it goes more positive, turn off the air handler and proceed to number 8.
8. Open and close the CAZ door. Record the most negative pressure, and note CAZ door position.

**Worst-case**

**depressurization:** Worst-case depressurization tests identify problems that weaken draft and restrict combustion air. The testing described here is intended to reveal the cause of the CAZ depressurization and spillage.

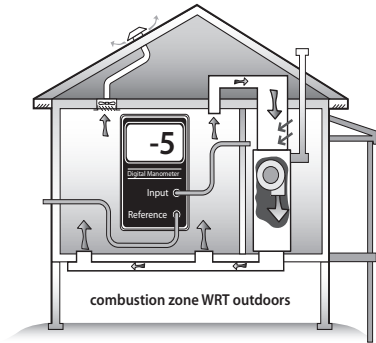

9. Calculate the net difference between the worst depressurization found from either #6 or #8 and the baseline pressure from #3. This is the worst-case depressurization.
10. Refer to *“Maximum CAZ Depressurization”* on page 570.
11. Specify improvement if the measured worst-case depressurization limit is exceeded. See *“Evaluating Combustion Air at Worst-Case”* on page 279.

## Analyzing CAZ Depressurization

Analyze the negative and positive pressures you measure in the CAZ to find workable solutions, using the troubleshooting table below.

Furnace Blower Off	Furnace Blower On
<p><b>CAZ Door Open</b> Negative CAZ Pressure</p> <p><b>Causes</b></p> <ul style="list-style-type: none"> <li>Stack effect</li> <li>Exhaust appliances</li> </ul> <p><b>Solutions</b></p> <ul style="list-style-type: none"> <li>Eliminate or reduce CFM of exhaust</li> </ul>	<p><b>CAZ Door Closed</b> Negative CAZ Pressure</p> <p><b>Causes</b></p> <ul style="list-style-type: none"> <li>Stack effect</li> <li>Exhaust appliances in the CAZ or affecting the CAZ</li> </ul> <p><b>Solutions</b></p> <ul style="list-style-type: none"> <li>Eliminate or reduce CFM of exhaust</li> <li>Isolate CAZ from the exhaust inside the building</li> </ul>
<p><b>Furnace Blower Off</b></p> <p><b>Causes</b></p> <ul style="list-style-type: none"> <li>Stack effect</li> <li>Supply duct leakage to outdoors</li> <li>Interior door closure</li> </ul> <p><b>Solutions</b></p> <ul style="list-style-type: none"> <li>Seal supply ducts</li> <li>Pressure relieve interior rooms</li> </ul> <p><b>Positive CAZ Pressure</b></p> <p><b>Causes</b></p> <ul style="list-style-type: none"> <li>Return duct leakage to out-</li> </ul>	<p><b>Furnace Blower On</b></p> <p>By: Tom Andrews INCAA Training Center,</p> <p><b>Negative CAZ Pressure</b></p> <p><b>Causes:</b></p> <ul style="list-style-type: none"> <li>Stack effect</li> <li>Return duct leakage in the CAZ</li> </ul> <p><b>Solutions</b></p> <ul style="list-style-type: none"> <li>Seal return ducts in the CAZ</li> </ul> <p><b>Positive CAZ Pressure</b></p> <p><b>Causes</b></p>

## Spillage and CO Testing

Next, verify that the appliance venting systems don't spill or produce excessive CO at worst-case depressurization. Test each appliance in turn for spillage and CO as described below.

1. Check for flue-gas flow in the venting system. Feel the vent connector for heat. The vent connector should start warming within 5 seconds if it establishes flue-gas flow. If the vent connector remains cold, stop the test and investigate.
2. Detect spillage at the draft diverter of each combustion appliance in one of these ways.
  - a. Smoke from a smoke generator is repelled by spillage at the draft diverter.
  - b. A mirror fogs at the draft diverter
3. If spillage in one or more appliances continues at worst-case depressurization for 2 minutes or more, take action to correct the problem.
4. Measure CO in the undiluted flue gases of each **space heater or water heater** after 2 minutes of operation at worst-case depressurization. If CO in undiluted flue gases is more than **100 ppm as measured or 200 ppm air-free** measurement, take action to reduce CO level.
5. Measure CO in the undiluted flue gases of each **furnace or boiler** after 2 minutes of operation at worst-case depressurization. If CO in undiluted flue gases is more than **200 ppm as measured or 400 ppm air-free** measurement, take action to reduce CO level.
6. Measure draft after 5 minutes.

**Spillage and draft:** Spillage and draft are two indications of whether the combustion gases are exiting the building as they should. In this guide, we focus on spillage because it's spillage we're trying to avoid, and we can detect it easily.

Positive draft indicates spillage, but not as reliably as checking for spillage itself. Evaluate spillage, unless you understand draft and know how to measure it.



**Spill switch:** If you don't trust an appliance to be spill-proof, install a spill switch that extinguishes the burner if the chimney spills.

## 8.2.5 Evaluating Combustion Air at Worst-Case

*SWS Detail: 5.0501 Combustion Appliance Zones; 5.0502 Combustion Air; 5.0502.1 Combustion Air - Fuel-Fired Appliances*

Combustion appliances need combustion air to support combustion and to balance the draft in natural-draft chimneys. In most buildings, combustion air comes through the building's air leaks. If workers seal the building tightly, they may reduce combustion air to a level that causes combustion problems or that allows depressurization. The worst-case testing procedure exposes most of these problems. This section tells how to evaluate combustion air during the worst-case depressurization test and by using a rule of thumb.

### Evaluating the CAZ Volume

In the average building with more than 0.40 natural air changes per hour (ACHn), the combustion appliance zone or CAZ should contain more than 50 cubic feet of volume for each 1000 BTUH of combustion-appliance input. However, a smaller volume may provide adequate combustion air and a larger volume may not depending on the airtightness of the CAZ.



**Combustion analysis:**  
Measuring  $O_2$  and CO during worst case is an effective way to evaluate the adequacy of combustion air.

## Evaluating Combustion Air by Flue-Gas Analysis

During worst-case testing, use a combustion analyzer to measure both CO and oxygen ( $O_2$ ). See *“Critical Combustion-Testing Parameters”* on page 293.

The  $O_2$  is an indicator of excess combustion air, and high CO may be an indicator of insufficient combustion air.

1. Sample undiluted flue gases as they leave the appliance’s heat exchanger during worst-case conditions.
2. If the  $O_2$  reading from the combustion analyzer is more than 5% with a natural-draft burner or more than 3% with a power burner or well adjusted and maintained barometric draft control, combustion air is probably adequate assuming CO is minimal.
3. If the  $O_2$  reading from the combustion analyzer is less than the above  $O_2$  values, this indicates that combustion air is inadequate or that the appliance is over-fired. We would expect significant CO to accompany such low  $O_2$  readings.
4. If  $O_2$  is too low, measure fuel input to verify that the firing rate is at or below the manufacturer’s BTUH specifications for input. An excessive firing rate could also cause low  $O_2$  and high CO.

5. If O<sub>2</sub> is too low at the correct firing rate, open a door or a window connected to the CAZ. If opening the CAZ door, a nearby window, an exterior door, or any combination of these increases the O<sub>2</sub> reading and decreases CO, then consider the options specified in “*Combustion-Air-Related Solutions*” on page 284.

## 8.2.6 Mitigating CAZ Depressurization and Spillage

*SWS Detail: 5.0501.1 Isolate CAZ; 5.0503.1 Fuel-Fired Appliance Venting; 5.0502.1 Combustion Air - Fuel-Fired Appliances; 5.0501 Combustion Appliance Zones*

If you find problems with CAZ depressurization or spillage, consider the improvements discussed next to solve the problems.

If the appliance spills or shows inadequate draft, open a window, exterior door, or interior door to observe whether the additional combustion airflow through that opening stops the spillage.

1. If this additional air improves draft, the problem is usually depressurization.
2. If this additional air doesn't stop the spillage, inspect the chimney. The chimney may be obstructed, undersized, oversized, or leaky.

### Improvements to Mitigate CAZ Depressurization

This list of improvements may solve spillage problems detected during the previous tests on a forced air heating system.

- ✓ Seal all return-duct leaks in the CAZ.
- ✓ Isolate combustion appliances from exhaust fans, clothes dryers, and return registers by air sealing between the CAZ and zones containing these depressurizing devices as described on [page 284](#).

- ✓ Provide make-up air for dryers and exhaust fans. *See page 341.*
- ✓ Reduce the CFM of exhaust appliances.

**Table 8-1: Spillage Problems and Solutions**

<b>Problem</b>	<b>Possible Solutions</b>
Spills immediately and continuously	Remove chimney blockage, seal chimney air leaks, or provide additional combustion air as necessary.
Exhaust fans cause spillage	Provide make-up or combustion air if opening a door or window to outdoors improves draft during testing.
Blower activation causes spillage	Seal return leaks in the furnace and in nearby return ducts. Isolate the furnace from nearby return registers.

### Chimney Improvements to Mitigate Spillage Problems

Suggest the following chimney improvements to mitigate spillage problems detected during the previous testing.

- Remove chimney obstructions.
- Repair disconnections or leaks at joints and where the vent connector joins a masonry chimney.
- Measure the size of the vent connector and chimney and compare to vent-sizing information listed in Chapter 13 of the *National Fuel Gas Code (NFPA 54)*. A vent connector or chimney liner that is either too large or too small can reduce draft.
- If wind interferes with draft, install a wind-dampening chimney cap.
- If the masonry chimney is deteriorated, install a new chimney liner.
- Increase the pitch of horizontal sections of vent.



- Increase the vertical rise of the vent connector, directly off the appliance vent fitting.

**Table 8-2: Combustion Problems and Possible Solutions**

<b>Problem</b>	<b>Possible causes and solutions</b>
Spillage with CAZ depressurization	Return duct leaks, clothes dryer, exhaust fans, other combustion vents. Seal return leaks. Isolate CAZ. Provide make-up air.
Spillage with no CAZ depressurization	Chimney or vent connector is blocked, leaky, incorrectly sized, or has inadequate slope. Or else CAZ is too airtight.
Excessive flue-gas CO	Mixture too rich or too lean. Adjust gas pressure. Check chimney and combustion air for code compliance.
Stack temperature or temperature rise too high or low	Adjust fan speed or gas pressure. Improve ducts to increase airflow.
Oxygen too high or low	Adjust gas pressure, but don't increase CO level.

### Fixing Persistent Depressurization and Spillage Problems

Sometimes buildings and their combustion appliances don't respond to the possible solutions listed previously. For persistent depressurization, spillage, and make-up air consider the following solutions.

- Replace open combustion appliances with sealed-combustion appliances.
- For an orphaned water heater either reline the chimney with a correctly sized chimney liner or replace gas or oil-fired water heaters with electric water heaters.
- If opening the CAZ door reduces worst-case CAZ depressurization, consider providing a vent between the CAZ and surrounding zones.

## 8.2.7 Combustion-Air-Related Solutions

*SWS Detail: 5.0501 Combustion Appliance Zones; 5.0502 Combustion Air; 5.0502.1 Combustion Air - Fuel-Fired Appliances; 5.0501.1 Isolate CAZ*

If combustion air is inadequate after trying the solutions in the previous sections, consider replacing open-combustion appliances with sealed-combustion appliances. The options discussed next have a risk of failure because of the unknowns with installing supplemental combustion air and isolating CAZs from the remainder of the building. Sealed-combustion is the ultimate answer to the problems of combustion air, depressurization, and spillage.

## 8.2.8 Zone Isolation for Natural-Draft Vented Appliances

*SWS Detail: 5.0501 Combustion Appliance Zones; 5.0502 Combustion Air; 5.0502.1 Combustion Air - Fuel-Fired Appliances; 5.0501.1 Isolate CAZ*

An isolated CAZ improves the safety of natural-draft vented appliances in some cases if replacing natural-draft appliances with sealed-combustion isn't an option. The CAZ is isolated if it receives combustion air only from outdoors or a ventilated intermediate zone. Inspect the CAZ for connections with the home's main zone and make sure it is isolated. **Consider the CAZ ceilings, walls, and interior door to be part of the thermal envelope.**

1. Seal all connections between the isolated CAZ and the home. Examples include joist spaces, forced-air grills, transfer grills, leaky doors, and holes for ducts or pipes.
2. Measure a base pressure from the CAZ to outdoors.

3. Set-up house in worst case, and verify that the set-up doesn't affect the CAZ pressure.
4. Measure CO and O<sub>2</sub> at worst-case and evaluate combustion air as described in *“Evaluating Combustion Air by Flue-Gas Analysis” on page 280*.
5. If the CAZ-to-outdoors pressure changed during worst-case, air seal the zone, and retest as described in steps 2 and 3.
6. If you can't air seal the CAZ adequately to isolate the zone, solve worst-case depressurization and spillage problems as described in *“Evaluating Combustion Air at Worst-Case” on page 279*.
7. Provide outdoor combustion air to the CAZ.
8. If your zone-isolation efforts fail to isolate and to provide outdoor combustion air, then the only safe option is to replace natural-draft appliances with sealed-combustion appliances.

## 8.3 COMBUSTION AIR

*SWS Detail: 5.0501 Combustion Appliance Zones; 5.0502 Combustion Air; 5.0502.1 Combustion Air - Fuel-Fired Appliances; 5.0501.1 Isolate CAZ*

A combustion appliance zone (CAZ) is classified as either an un-confined space or confined space. An un-confined space is a CAZ having the NFPA-required amount of room volume that is assumed to provide enough combustion air. A confined space is a CAZ with less than the NFPA-required amount of volume.

A confined space is defined by NFPA 54 as a room containing one or more combustion appliances that has less than 50 cubic feet of volume for every 1000 BTUH of appliance input.

For confined spaces, the NFPA 54 requires additional combustion air from outside the CAZ. Combustion air is supplied to the combustion appliance in four ways.

1. To an un-confined space through leaks in the building.
2. To a confined space through an intentional opening or openings between the CAZ and other indoor areas where air leaks replenish combustion air.
3. To a confined space through an intentional opening or openings between the CAZ and outdoors or ventilated intermediate zones like attics and crawl spaces.
4. Directly from the outdoors to the appliance. Appliances with direct combustion air supply are called sealed-combustion or direct vent appliances.

**Important Note:** The National Fuel Gas Code (NFPA 54 – 2009) presents two methods for calculating combustion air. The simplest of the two methods is discussed in this section. We discuss this method because mechanical inspectors often refer to it. However, neither method really predicts the amount of available combustion air.

The best way to evaluate the combustion air in an existing building with an existing combustion heating system is with an electronic combustion analysis. **If the oxygen reading from the combustion analyzer is more than 5%, this oxygen (O<sub>2</sub>) measurement verifies that an adequate amount of combustion air is available.** At 5% or more of flue-gas oxygen, additional combustion air is usually unnecessary.

### 8.3.1 Un-Confined-Space Combustion Air

Combustion appliances located in most basements, attics, and crawl spaces get adequate combustion air from leaks in the building shell. Even when a combustion appliance is located within the home's living space, it gets adequate combustion air from air leaks, unless the house is airtight or the combustion zone is depressurized.

## 8.3.2 Confined-Space Combustion Air

A confined space is defined by NFPA 54 as a room containing one or more combustion appliances that has less than 50 cubic feet of volume for every 1000 BTUH of appliance input.

However, if a small mechanical room is connected to adjacent spaces through large air passages like floor-joist spaces, the CAZ may not need additional combustion air despite sheeted walls and a door separating the CAZ from other indoor spaces. You can measure the connection between the CAZ and other spaces by worst-case draft testing or blower door pressure testing.

When the home is unusually airtight ( $<0.20$  ACHn), the CAZ may not have adequate combustion air, even when the combustion zone is larger than the minimum confined-space room volume.

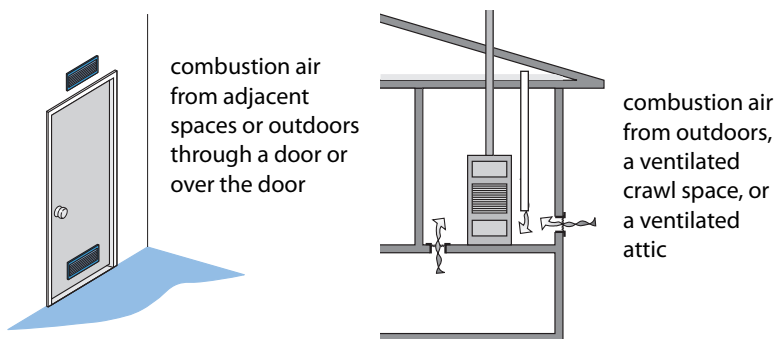

**Combustion air options:** Combustion air can be supplied from adjacent indoor spaces or from outdoors. High vents may occasionally compete with chimney draft for available air. Beware of drawing combustion air from wet crawl spaces. Pick your outdoor combustion-air location carefully to avoid pressurizing or depressurizing the CAZ.

### Combustion-Air Openings

In confined spaces or airtight homes where combustion appliances need outdoor combustion air, NFPA 54 prefers a single vent opening installed as low in the CAZ as practical. A combustion air vent into an attic may depressurize the CAZ and

deliver warm moist air from the CAZ into a cold attic. Instead, connect the combustion zone to a ventilated crawl space (if it's dry) or directly to the outdoors through a single low vent if possible.

For the intake, choose an outdoor location that is sheltered from prevailing winds, but not in an inside corner. Don't choose an exterior wall that is parallel to prevailing winds. Wind blowing parallel to the exterior wall or at a right angle to the vent opening de-pressurizes both the vent and the CAZ connected to it.

*Table 8-3 on page 290* gives sizing guidelines for combustion air openings. After installing supplemental combustion air, repeat the worst-case testing to verify that you've solved the combustion air problem and that the combustion is safe.

### Grilles and Louvers

Combustion-air vents should be no less than 3 inches in their smallest dimension. A vent with a louver or grille has a net free area (NFA) that is smaller than actual vent area because NFA accounts for the blocking effect of louvers and grilles. Metal grilles and louvers provide about 75% of their area as net-free area while wood louvers provide only about 25%.

### Air Boots for Power Burners

At least one company manufactures a proprietary combustion-air system that introduces outdoor air through an air boot

which attaches to a combustion-air duct to outdoors. The most common application is for power oil burners.



**Combustion air boot:** This metal boot attaches to the air intake of a power burner to provide combustion air from outdoors.

### Fan-Powered Combustion Air

At least one company manufactures a proprietary combustion-air system that introduces outdoor air through a fan that sits on the floor and attaches to a combustion-air duct to outdoors, and some large buildings simply use a fan mounted in an otherwise undersized combustion-air opening.

If a fan provides combustion air to open-combustion furnaces and water heaters, the fan should provide  $\frac{1}{3}$  to  $\frac{1}{2}$  CFM per 1000 BTUH of forced combustion air.

Pressurizing a mechanical room should be avoided, because it can force products of combustion into the living space. If the fan is too big for the appliances, use a barometric damper on the fan intake to mix room air with incoming outdoor air.

**Table 8-3: Combustion-Air Openings: Location and Size**

Location	Dimensions
Two direct openings to adjacent indoor space	Minimum area each: 100 in <sup>2</sup> 1 in <sup>2</sup> per 1000 BTUH each Combined room volumes must be ≥ 50 ft <sup>3</sup> /1000 BTUH
Two direct openings or vertical ducts to outdoors	Each vent should have 1 in <sup>2</sup> for each 4000 BTUH
Two horizontal ducts to outdoors or ventilated intermediate zone	Each vent should have 1 in <sup>2</sup> for each 2000 BTUH
Single direct or ducted vent to outdoors or ventilated intermediate zone	Single vent should have 1 in <sup>2</sup> for each 3000 BTUH

From the *National Fuel Gas Code 2009 (NFPA 54)*

### Example Combustion Air Calculation

Here is an example of one indoor space providing combustion air to another indoor space. The furnace and water heater are located in a confined space. The furnace has an input rating of 100,000 BTUH. The water heater has an input rating of 40,000 BTUH. Therefore, there should be 140 in<sup>2</sup> of net free area of vent between the mechanical room and other rooms in the home.

$$[(100,000 + 40,000) \div 1,000] = 140 \times 1 \text{ IN}^2 = 140 \text{ IN}^2$$

Each vent should therefore have a minimum of 140 in<sup>2</sup> net free area. If a metal grill covers 60% of the opening's area, divide the 140 in<sup>2</sup> by 0.60.

$$140 \text{ IN}^2 / 0.6 = 233 \text{ IN}^2$$



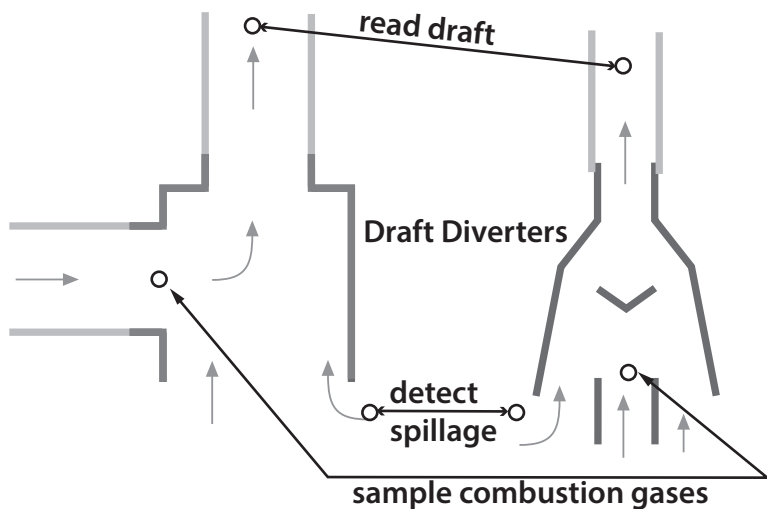

**Testing locations:** This illustration shows two draft diverters and the locations (circles) for draft testing, spillage detection, and sampling of combustion gases.

## 8.4 ELECTRONIC COMBUSTION ANALYSIS

The goal of a combustion analysis is to quickly analyze combustion safety and efficiency. When the combustion appliance reaches steady-state efficiency (SSE), you can measure its most critical combustion parameters. This information saves time and informs both service and installation adjustments.



### **Video: Heating and Cooling efficiency**

— An explanation of the various types in terms related to efficiency

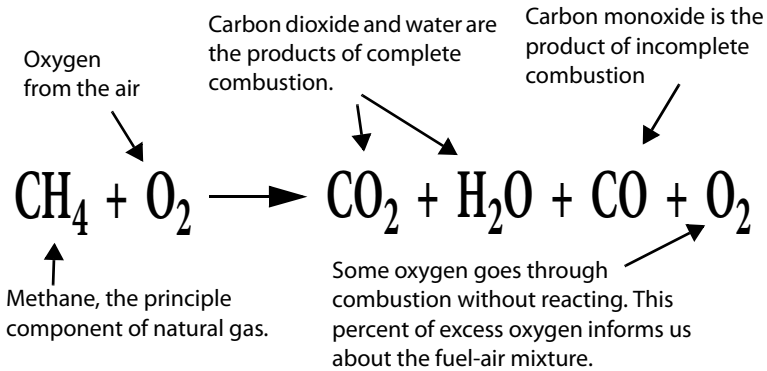

Modern combustion analyzers measure  $\text{O}_2$ ,  $\text{CO}$ , and flue-gas temperature. Some models also measure draft. Combustion analyzers also calculate combustion efficiency or steady-state efficiency (SSE), which are synonymous.

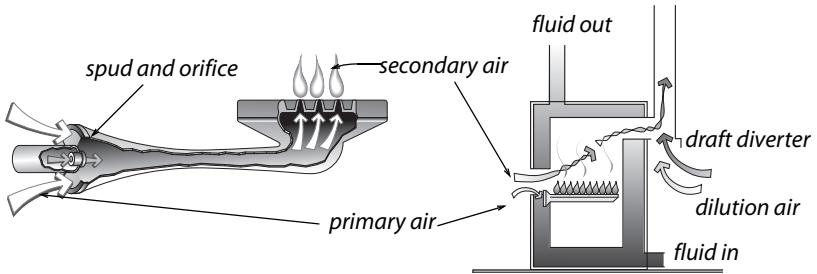

**Natural-draft, open combustion gas burners:** Combustion air comes from the indoors in open combustion appliances. These burners use the heat of the flame to pull combustion air into the burner. Dilution air, entering at the draft diverter, prevents overfire draft from becoming excessive.



**70+ Furnace:** Sample flue gases within the draft diverter inside each exhaust port.



**80+ Furnace:** Measure draft and sample flue gases in the vent connector above the furnace.

## 8.4.1 Critical Combustion-Testing Parameters

These furnace-testing parameters tell you how efficient and safe the furnace currently is and how much you might be able to improve efficiency. Use these measurements to analyze the combustion process.

*Carbon monoxide (CO) (ppm):* Poisonous gas indicates incomplete combustion. Modern combustion analyzers let you choose between an as-measured value or a calculated value that states the concentration of CO in theoretical **air-free** flue gases. Adjusting combustion to produce less than 100 ppm as measured or 200 ppm air-free is almost always possible with fuel-pressure adjustments, air adjustments, or burner maintenance.

*Oxygen (percent):* Indicates the percent of excess air and whether fuel-air mixture is within a safe and efficient range. Efficiency increases as oxygen decreases because excess air, indicated by the O<sub>2</sub> carries heat up the chimney. Percent O<sub>2</sub> may also indicate the cause of CO as either too little or too much

combustion air. Technicians used to measure CO<sub>2</sub>, but O<sub>2</sub> is easier to measure, and you only need to measure one of these two gases.

*Flue-gas temperature:* Flue-gas temperature is directly related to furnace efficiency. Too high flue-gas temperature wastes energy and too-low flue-gas temperature causes corrosive condensation in the venting system.

*Smoke number:* For oil only, this measurement compares the stain made by flue gases with a numbered stain-darkness rating called smoke number. Smoke number should be 1 or lighter on a 1-to-10 smoke scale.

*Draft:* The pressure in the chimney or vent connector (chimney draft or breech draft). Also the pressure in the combustion chamber (over-fire draft), used primarily with oil power burners.

**Table 8-4: Combustion Standards for Gas Furnaces and Boilers**

<b>Performance Indicator</b>	<b>SSE 70+</b>	<b>SSE 80+</b>	<b>SSE 90+</b>
Carbon monoxide (CO) (ppm as measured/air-free)	<200 ppm/ 400 ppm	<200 ppm/ 400 ppm	<200 ppm/ 400 ppm
Stack temperature (°F)	350°–475°	325°–450°	<120°
Oxygen (%O <sub>2</sub> )	5–10%	4–9%	4–9%
Natural gas pressure inches water column (IWC)	3.2–4.2 IWC*	3.2–4.2 IWC*	3.2–4.2 IWC*
LP gas pressure	10–12 IWC	10–12 IWC	10–12 IWC
Steady-state efficiency (SSE) (%)	72–78%	78–82%	92–97%
Chimney draft (IWC, Pa.)	–0.020 IWC –5 Pa.	–0.020 IWC –5 Pa.	0.100– 0.250 IWC +25–60 Pa.
* pmi = per manufacturer’s instructions Use these standards also for boilers except for temperature rise. See <i>“Minimum Oil Burner Combustion Standards” on page 317.</i>			

**Table 8-5: Carbon Monoxide Causes and Solutions**

Cause	Analysis & Solution
Flame smothered by combustion gases.	Chimney backdrafting from CAZ depressurization or chimney blockage.
Burner or pilot flame impinges.	Align burner or pilot burner. Reduce gas pressure if excessive.
Inadequate combustion air with too rich fuel-air mixture.	O <sub>2</sub> is <6%. Gas input is excessive or combustion air is lacking. Reduce gas or add combustion air.
Blower interferes with flame.	Inspect heat exchanger. Replace furnace or heat exchanger.
Primary air shutter closed.	Open primary air shutter.
Dirt and debris on burner.	Clean burners.
Excessive combustion air cooling flame.	O <sub>2</sub> is >10%. Increase gas pressure.

## 8.5 HEATING SYSTEM REPLACEMENT

This section discusses replacing combustion furnaces and boilers. We'll also discuss gas heating-replacement and oil-heating-replacement specifications.

See *“NFPA Codes” on page 268* and *“ANSI/ACCA Manuals” on page 268*.

### 8.5.1 Combustion Furnace Replacement

*SWS Detail: 5.0108.4 Furnaces; 5.0108 Equipment Installation 5.8801 Equipment Removal; 5.0104 Duct Installation; 5.0105 Duct Repair; 5.0106 Duct Sealing; 5.0504.1 Natural Gas/Propane Fuel Piping*

This section discusses air handlers of combustion furnaces and also heat pumps. Successful air-handler replacement requires selecting the right heat (and cooling) input, blower model, and

blower speed. The installation must include repairs to ducts and other remaining components, and testing to verify that the new air handler operates correctly.

See “*NFPA Codes*” on page 268 and “*ANSI/ACCA Manuals*” on page 268.

## Preparation

- ✓ Recover refrigeration in the existing heating-cooling unit according to EPA regulations.
- ✓ Disconnect and remove the furnace or heat pump, attached air-conditioning equipment, and other materials that won't be reused.
- ✓ Transport these materials off the client's property to a recycling facility.
- ✓ Verify that all accessible ducts were sealed as part of the furnace's installation, including the air handler, the plenums, and the branch ducts.

## Equipment Selection

- ✓ Evaluate the building to determine the correct size of the furnace, using ACCA Manual J or equivalent method. Select the smallest BTUH output furnace that your preferred manufacturer offers and that exceeds your heat loss calculation.
- ✓ Select the air handler using ACCA Manual S or equivalent method along with manufacturers' air-handler specifications. Consider blower airflow requirements for air conditioning if there is existing central air conditioning.
- ✓ Select the most energy efficient blower available. Prefer electrically commutated motors (ECM) when possible.
- ✓ Select the supply and return registers using ACCA Manual T or equivalent method.

## Air-Handler Installation

- ✓ Install MERV 6 or higher filter inside or outside of the new furnace.
- ✓ The filter must be easy to replace.
- ✓ The filter retainer must hold the filter firmly in place.
- ✓ The filter must provide complete coverage of blower intake or return grille. The filter compartment must not permit air to bypass the filter.
- ✓ If flue-gas temperature or supply air temperature are unusually high, check static pressure and fuel input. *See “Ducted Air Distribution” on page 341.*
- ✓ Attach the manufacturer’s literature including, operating manual and service manual, to the furnace.

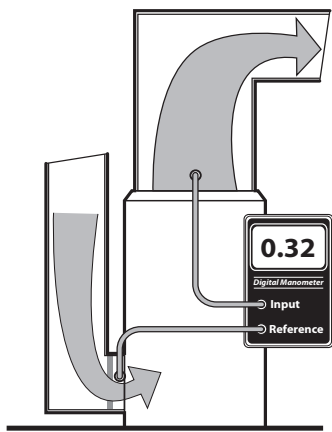

**Static pressure and temperature rise:** Measure static pressure and temperature rise across the new furnace to verify that the duct system isn't restricted. The correct airflow, specified by the manufacturer, is necessary for high efficiency.

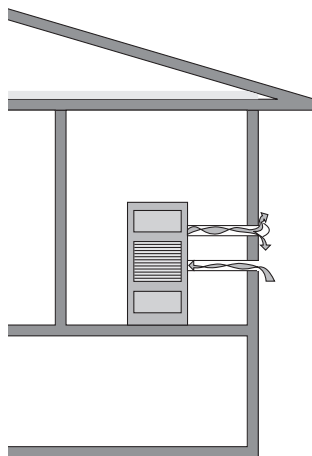

**Sealed combustion heaters:** Sealed-combustion furnaces prevent the air pollution and house depressurization caused by some open-combustion furnaces.

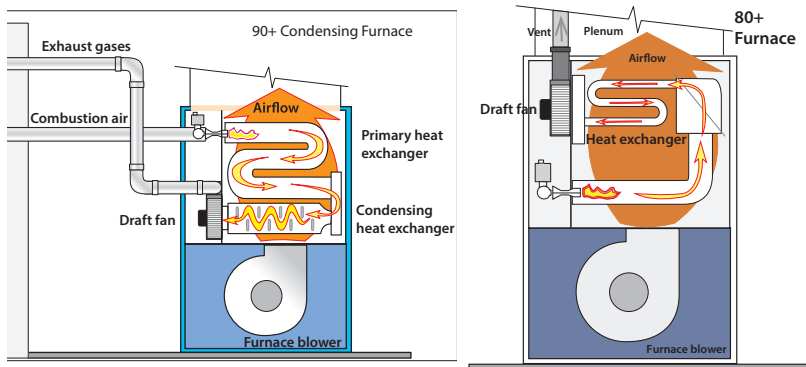

**90+ Gas furnace:** A 90+ furnace has a condensing heat exchanger and a stronger draft fan for pulling combustion gases through its more restrictive heat exchanger and establishing a strong positive draft.

**80+ Gas furnace:** An 80+ furnace has a restrictive heat exchanger and draft fan, but has no draft diverter and no standing pilot light.

## Supporting Air Handlers

Support the new air handlers using these specifications.

- Support horizontal air handlers from below with a non-combustible, water-proof, and non-wicking material. Or support the horizontal air handler with angle iron and threaded rod from above.
- Support upflow air handlers with corner support legs, bricks, or pads from below when necessary to hold it above a damp basement floor.
- Support downflow air handlers with a strong, airtight supply plenum. Insulate this supply plenum on the exterior of the plenum.

## 8.5.2 Gas-Fired Heating Installation

*SWS Detail: 5.0108 Equipment Installation; 5.0203 Equipment Installation 5.0108.4 Furnaces; 5.0203.1 Boilers; 5.8801 Equipment Removal; 5.0504.1 Natural Gas/Propane Fuel Piping*



The goals of gas-appliance replacement are to save energy and improve heating safety. The heating replacement project should produce a gas-fired heating system in virtually new condition, even though existing components like the gas lines, chimney, pipes, or wiring may remain.

See *“NFPA Codes” on page 268* and *“ANSI/ACCA Manuals” on page 268*.

Include maintenance or repair of existing components as part of the installation. Analyze design defects in the original system, and correct the defects during the heating system’s replacement.

- ✓ If possible, install a condensing sealed-combustion (direct vent) furnace or boiler with a 90+ AFUE.
- ✓ Install non-condensing furnaces and boilers with a minimum AFUE of 80%, if the 90% replacement unit isn’t cost-effective or practical.
- ✓ Install new gas-fired unit with adequate clearances to allow maintenance.
- ✓ Follow manufacturer’s venting instructions along with the National Fuel Gas Code (NFPA 54) to install a proper venting system. *See “Inspecting Venting Systems” on page 326.*
- ✓ Check clearances of the heating unit and its vent connector to nearby combustibles, according to NFPA 54. *See page 326.*
- ✓ Measure the new unit’s gas input, and adjust the gas input if necessary.

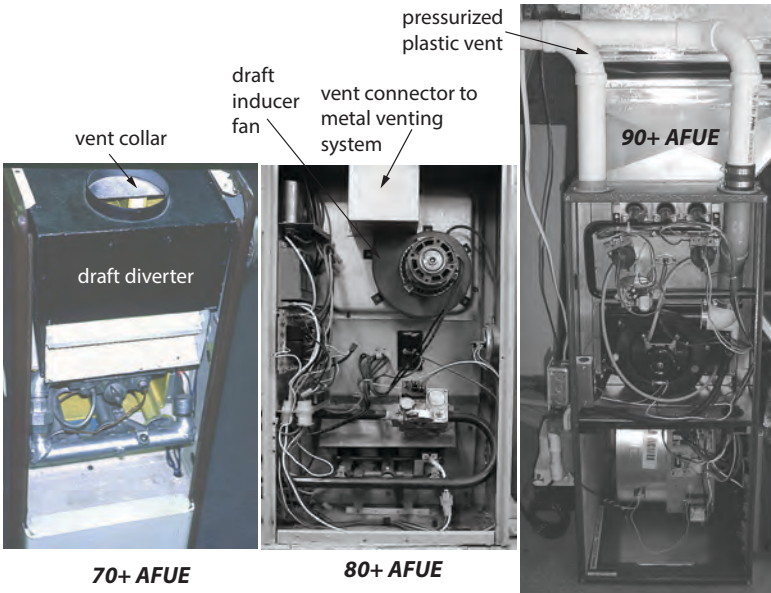

**Gas furnace evolution:** Energy auditors should be able to identify the 3 types of gas and propane furnaces. Only the 90+ AFUE furnace has a pressurized vent. The two earlier models vent into traditional natural-draft chimneys.

## Testing New Gas-Fired Heating Systems

- ✓ Do a combustion test, and adjust fuel-air mixture to minimize  $O_2$ . However don't allow CO beyond 200 ppm as measured or 400 ppm air-free with this adjustment. [See pages 273 and 311.](#)
- ✓ Verify that the gas water heater vents properly after installation of a sealed-combustion or horizontally vented furnace or boiler. Install a chimney liner if necessary to provide right-sized venting for the water heater.

## 8.5.3 Combustion Boiler Replacement

*SWS Details: 5.0203.1 Boilers; 5.0202 Distribution; 5.0288.1 Boiler Room Water Drainage; 5.0204.1 Fuel-Fired Boilers; 5.8801 Equipment Removal; 5.0504.1 Natural Gas/Propane Fuel Piping*

Technicians replace boilers as an energy-conservation measure or for health and safety reasons.

Boiler piping and controls present many options for zoning, boiler staging, and energy-saving features. Dividing homes into zones, with separate thermostats, can significantly improve energy efficiency compared to operating a single zone.

Follow these specifications when recommending a replacement boiler.

See *“NFPA Codes” on page 268* and *“ANSI/ACCA Manuals” on page 268*.

### Boiler Design

A boiler’s seasonal efficiency is more sensitive to correct sizing than is a furnace’s efficiency.

- ✓ Consider weatherization work that reduced the heating load serviced by the previous boiler when sizing the new boiler.
- ✓ Determine the correct size of the boiler. Use ACCA Manual J or Manual N.
- ✓ Use the current version of ANSI/ACCA Manual S or Manual CS or equivalent procedures to select the boiler.
- ✓ Along with calculations from these manuals, consider the total installed radiation surface area connected to the boiler and also the radiator sizes in individual rooms.
- ✓ Select heating equipment of the lowest capacity required to meet the design heating load, and provide sufficient vol-

ume for components of the existing distribution system that remains in place.

- ✓ Size new radiators according to room heat loss and design water temperature.
- ✓ Select a boiler that is ENERGY STAR® certified or equivalent.
- ✓ Install unit in a dry location and within conditioned space when possible.
- ✓ Provide ease of access for routine maintenance/service on all system components requiring maintenance or service.

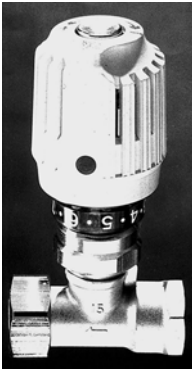

**Radiator temperature control:**  
RTCs work well for controlling room temperature, especially in overheated rooms.

## Pump and Piping

- ✓ Verify a functioning pressure-relief valve, expansion tank, air-excluding device, back-flow preventer, and an automatic fill valve must be part of the new hydronic system.
- ✓ Verify that all supply piping is insulated with foam or fiberglass pipe insulation.
- ✓ Suggest that the pump be installed near the downstream side of the expansion tank to prevent the suction side of the pump from depressurizing the piping, which can pull air into the piping system.

- ✓ Replace the expansion tank, unless it's the proper size for the new system. Adjust the expansion tank for the correct pressure during boiler installation. *See page 379.*
- ✓ Extend new piping and radiators to conditioned areas, like additions and finished basements, which are currently heated by space heaters.

## Controls

- ✓ Maintaining a low-limit boiler-water temperature is wasteful. Boilers should be controlled for a cold start, unless the boiler is used for domestic water heating.
- ✓ For large boilers, install reset controllers that adjust supply water temperature according to outdoor temperature and prevent the boiler from firing when the outdoor temperature is above a setpoint where heat isn't needed.

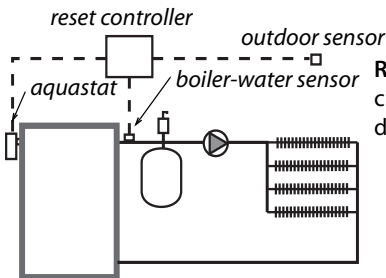

**Reset controller:** This control adjusts circulating-water temperature depending on the outdoor temperature.

- ✓ Verify that return-water temperature is above 130° F for gas and above 150° F for oil, to prevent acidic condensation within the boiler, unless the boiler is designed for condensation. Install piping bypasses, mixing valves, primary-secondary piping, or other strategies, as necessary, to prevent condensation within a non-condensing boiler.
- ✓ Specify radiator temperature controls (RTCs) for areas with a history of overheating.

## Combustion Testing

- ✓ Inspect the chimney and upgrade it if necessary.

- ✓ Verify that flue-gas oxygen and temperature are within the ranges specified in these two tables.
  - a. *“Combustion Standards for Gas Furnaces and Boilers” on page 294*
  - b. *“Minimum Oil Burner Combustion Standards” on page 317*

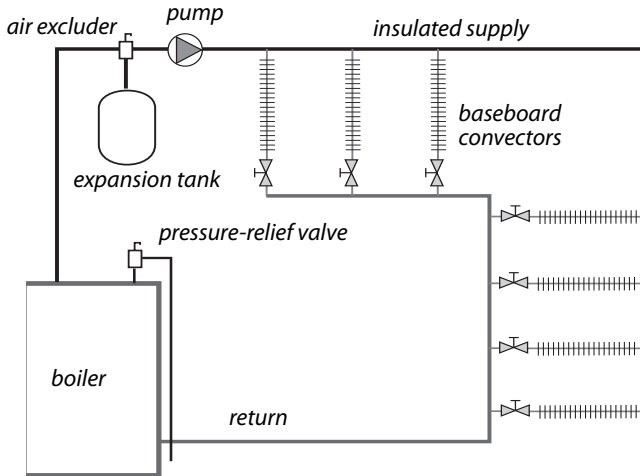

**Simple reverse-return hot-water system:** The reverse-return method of piping is the simplest way of balancing flow among the heat emitters.

## Steam Boilers

Steam-boiler performance is heavily dependent on the performance of the existing steam distribution system. The boiler installer should know how the distribution system performed when it was connected to the old boiler.

The new boiler's water line should be at the same height as the old boiler's water line, or the installers should know how to compensate for the difference in water-line levels. *See "Steam Heating and Distribution" on page 382.*

## 8.5.4 Oil-Fired Heating Installation

*SWS Detail: 5.0504.2 Oil Piping; 5.0108 Equipment Installation; 5.0203 Equipment Installation 5.0108.4 Furnaces; 5.0203.1 Boilers; 5.8801 Equipment Removal*

Oil-heating replacement should provide an oil-fired heating system in virtually new condition, even though components like the oil tank, chimney, piping, and wiring may remain in place.

Any maintenance or repair for these remaining components should be part of the replacement job. Analyze design defects of the original system, and correct them during the heating-system replacement.

- ✓ New oil-fired furnaces and boilers should have a minimum AFUE of 83%.
- ✓ Install new oil-fired furnaces and boilers with adequate clearances to facilitate maintenance.
- ✓ Inspect the existing chimney and the vent connector. Replace the vent connector with Type L double-wall vent pipe if necessary.
- ✓ Install a stainless steel chimney liner if necessary. *See "Special Venting Considerations for Gas" on page 336.*

**Oil heating system:**  
Components of an oil heating system may need replacement, repair, or cleaning during replacement of the furnace or boiler.

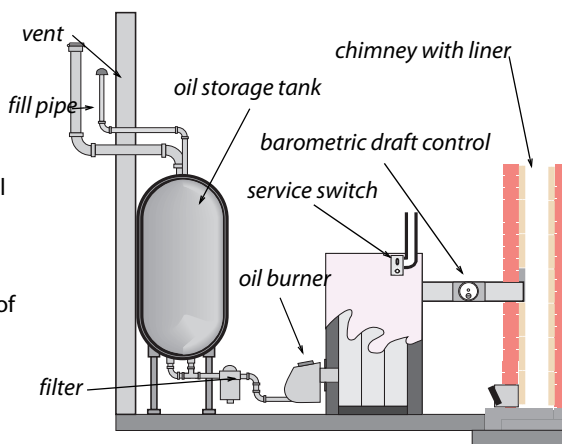

- ✓ Verify that the clearances between the vent connector and nearby combustibles are adequate. See *“Clearances to Combustibles for Vent Connectors”* on page 328.
- ✓ Install a new fuel filter, and purge the fuel lines as part of the new installation.

See *“NFPA Codes”* on page 268 and *“ANSI/ACCA Manuals”* on page 268.

## Controls

- ✓ Verify that a working emergency shut-off is installed in the living space.
- ✓ Look for a control that interrupts power to the burner in the event of a fire.
- ✓ Measure the transformer voltage to verify that it complies with the manufacturer’s specifications.
- ✓ Measure the control circuit amperage, and adjust the thermostat’s heat anticipator to match the amperage. Or, follow the thermostat manufacturer’s instructions for adjusting cycle length.

## Testing New Oil-Fired Heating Systems

- ✓ Verify that the oil pressure matches the manufacturer’s specifications, but isn’t less than 100 psi.
- ✓ If the flue-gas temperature is too high, adjust oil pressure per manufacturers instructions or replace nozzle as necessary to produce the correct input and flue-gas temperature.



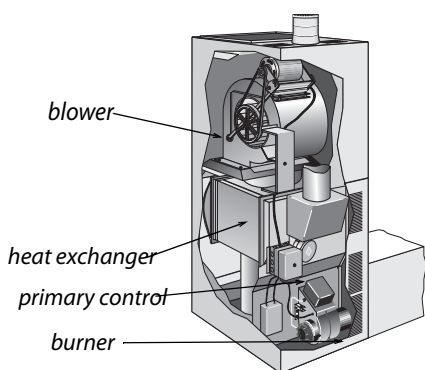

**Oil-fired downflow furnaces:**  
Their design hasn't changed much in recent years except for the flame-retention burner.

- ✓ Verify that the spray angle and spray pattern fit the size and shape of the combustion chamber.
- ✓ Adjust oxygen, flue-gas temperature, and smoke number to match manufacturer's specifications or specifications given here. Smoke number should be zero on all modern oil-fired equipment.

## 8.5.5 Evaluating Oil Tanks

### *SWS Detail: 5.0504.2 Oil Piping*

Inspect the oil tank, and remove dirt and moisture at bottom of the tank. Verify that the oil tank and oil lines comply with NFPA 31.

Oil tanks are now almost always installed above ground. But many old oil tanks are still buried. Inspect above-ground tanks to find leaks.

Below-ground tanks and above-ground tanks can both be evaluated by tests for water in the fuel system.

1. Start by inspecting the oil filter for corrosion. Corrosion in the oil filter indicates a high probability of water and corrosion in the tank.

2. Next use water-finding paste, applied to the end of a probe, to detect water at the bottom of the oil tank. For indoor tanks, you'll need a flexible probe because of the ceiling-height limitations.

See *“NFPA Codes” on page 268* and *“ANSI/ACCA Manuals” on page 268*.

### Inspecting Above-Ground Oil Tanks

Indoor oil leaks are usually accompanied by petroleum smells. Inspect the oil tank as well as all the oil piping between the oil tank and the oil-fired furnace.

- ✓ Look for different colors on the tank from condensation, corrosion, or fuel leaks.
- ✓ Look at the bottom of the oil tank and see if oil is dripping from a leak.
- ✓ Look for patches from previous leaks.
- ✓ If the oil tank is new, don't mistake previous oil-tank leaks for leaks in the new tank.
- ✓ Use the water test described previously.

If you smell oil but you can't see the leak, consider the following tests.

- ✓ Use the water test described previously.
- ✓ For hidden leaks, consider ultrasound leak detection by a oil-tank specialist.

### Advice for Below-Ground Oil Tanks

Leaky below-ground oil tanks are a financial problem and a major environmental problem. Local, state, or federal authorities may require homeowners to remove the tank, abandon it in place, or have it leak-tested by one of the following methods.

- ✓ Use the water testing described previously.

- ✓ A tank specialist collects multiple soil samples from around the tank and analyzes them for petroleum contamination by an approved method.

## 8.6 COMBUSTION SPACE HEATER REPLACEMENT

*SWS Detail: 5.0301 Room Conditioning; 5.0301.3 Wall Furnace; 5.05 Combustion Safety; 5.0502 Combustion Air; 5.8801 Equipment Removal; 5.0504 Fuel Delivery*

Space heaters are inherently more efficient than central heaters, because they have no ducts or distribution pipes.

See “*NFPA Codes*” on page 268 and “*ANSI/ACCA Manuals*” on page 268.

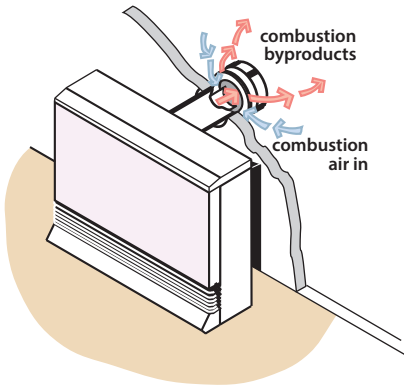

**Sealed-combustion space heater:**  
Sealed-combustion space heaters draw combustion air in, using a draft fan.



**Space heater controls:** Many modern energy-efficient space heaters have programmable thermostats as a standard feature.

Weatherization agencies replace space heaters as an energy-conservation measure or for health and safety reasons. Choose a sealed-combustion space heater. Inspect existing space heaters for health and safety problems.

- ✓ If power outages are common, select a space heater that operates without electricity.

- ✓ Follow manufacturer's venting instructions carefully. Don't vent sealed-combustion or induced-draft space heaters into naturally drafting chimneys.
- ✓ Verify that flue-gas oxygen and temperature are within the ranges specified in *Table 8-4 on page 294*.
- ✓ If the space heater sits on a carpeted floor, install a fire-rated floor protector.
- ✓ Install the space heater away from traffic, draperies, and furniture.
- ✓ Provide the space heater with a correctly grounded duplex receptacle for its electrical service.

### 8.6.1 Space Heater Operation

Communicate the following operating instructions to the occupants.

- ✓ Don't store any objects near the space heater that would restrict airflow around it.
- ✓ Don't use the space heater to dry clothes or for any purpose other than heating the home.
- ✓ Don't allow anyone to lean or sit on the space heater.
- ✓ Don't spray aerosols near the space heater. Many aerosols are flammable or they can corrode the space heater's heat exchanger.

### 8.6.2 Unvented Space Heaters

#### *SWS Detail: 5.8801 Equipment Removal*

Unvented space heaters include ventless gas fireplaces and gas logs installed in fireplaces previously designed for wood-burning or coal-burning. These unvented space heaters create indoor air pollution because they deliver all their combustion byprod-

ucts to the indoors. Unvented space heaters aren't safe. Replace them with vented space heaters or electric space heaters.

DOE forbids unvented space heaters as primary heating units in weatherized homes. However, unvented space heaters may be used as secondary heaters, under these four requirements.

1. The heater must have an input rating less than 40,000 BTUH.
2. If located in a bedroom, the heater must have an input rating of less than 10,000 BTUH.
3. The heater must be equipped with an oxygen-depletion sensor.
4. The room containing the heater must have adequate combustion air.
5. Home must have adequate ventilation: *See "Whole-Dwelling Ventilation Requirement" on page 415.*

## 8.7 GAS BURNER SAFETY & EFFICIENCY SERVICE

### *SWS Detail: 5.8801 Equipment Removal*

Gas burners should be inspected and maintained during a service call. These following specifications apply to gas furnaces, boilers, water heaters, and space heaters.

See *"NFPA Codes" on page 268* and *"ANSI/ACCA Manuals" on page 268.*

### 8.7.1 Combustion Efficiency Test for Furnaces

Perform the following procedures at steady-state to verify a furnace's correct operation.

- Perform a combustion test using a electronic flue-gas analyzer. Recommended flue-gas temperature depends on the

type of furnace and is listed in the table titled, “*Combustion Standards for Gas Furnaces and Boilers*” on page 294.

- Measure temperature rise (supply minus return temperatures). Temperature rise should be within the manufacturer’s specifications for a furnace or boiler: between 30° and 70°.
- If O<sub>2</sub> is high, or the estimated output from the table is low, increase gas pressure until you measure 6% O<sub>2</sub> if possible, as long as you don’t create CO in the process.
- Increase gas pressure if needed to increase temperature rise and flue-gas temperature.

If you know the airflow through the furnace from measurements described in “*Ducted Air Distribution*” on page 341, you can use the table, “*Carbon Monoxide Limits*” on page 571, to check whether output is approximately what the manufacturer intended. Dividing this output by measured input as described above gives you another check on the steady-state efficiency.

## 8.7.2 Inspecting Gas Combustion Equipment

Perform the following inspection procedures on all gas-fired furnaces, boilers, water heaters, and space heaters, as necessary.

- ✓ Look for soot, melted wire insulation, and rust in the burner and manifold inside and outside the burner compartment. These signs indicate flame roll-out, combustion gas spillage, CO, and incomplete combustion.
- ✓ Inspect the burners for dust, debris, misalignment, flame-impingement, and other flame-interference problems. Clean, vacuum, and adjust as needed.
- ✓ Inspect the heat exchanger for cracks, holes, or leaks.
- ✓ Verify that furnaces and boilers have dedicated circuits with safety shutoffs near the appliance. Verify that all 120-volt wiring connections are enclosed in covered electrical boxes.

- ✓ Verify that pilot is burning (if equipped) and that main burner ignition is satisfactory.
- ✓ Check venting system for proper diameter and pitch. *See page 326.*
- ✓ Check venting system for obstructions, blockages, or leaks.
- ✓ Observe flame characteristics. Flames should be blue and well shaped. If flames are white or yellow, the burner may suffer from faulty combustion.

### 8.7.3 Testing and Adjustment

The goal of these measures is to reduce carbon monoxide (CO), stabilize flame, and verify the operation of safety controls.

- ✓ Do an electronic combustion analysis and note the oxygen, CO, and flue-gas temperature.
- ✓ Test for spillage or measure draft. Take action to improve the draft if it is inadequate because of improper venting, obstructed chimney, leaky chimney, or depressurization. *See page 279.*

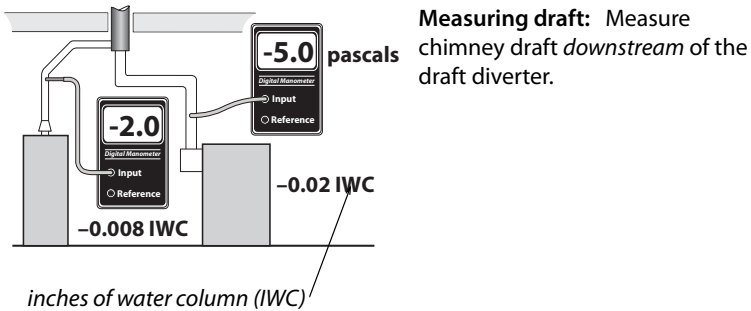

- ✓ If you measure CO and the measured oxygen level is low, open a window while observing CO level on the meter to see if CO is reduced by increasing the available combustion air through the open window. *See page 341.*
- ✓ Adjust gas input if combustion testing indicates over-firing or under-firing.

- ✓ For programmable thermostats, read the manufacturer's instructions about how to control cycle length. These instructions may be printed inside the thermostat.

## Burner Cleaning

Clean and adjust the burner if any of these conditions exists.

- CO is greater than 100 ppm as measured or 200 ppm air-free measurement for space heaters and water heaters and 200 ppm as measured or 400 air-free for furnaces or boilers.
- Visual indicators of soot or flame roll-out exist.
- Burners are visibly dirty.
- Measured draft is inadequate. *See page 326.*
- The appliance hasn't been serviced for two years or more.

## Maintenance and Cleaning

Gas-burner and gas-venting maintenance should include the following measures.

- ✓ Remove causes of CO and soot, such as over-firing, closed primary air intake, flame impingement, and lack of combustion air.
- ✓ Remove dirt, rust, and other debris that may be interfering with the burners. Clean the heat exchanger if there are signs of soot around the burner compartment.
- ✓ Seal leaks in vent connectors and chimneys.

## 8.8 OIL BURNER SAFETY AND EFFICIENCY SERVICE

Oil burners require annual maintenance to maintain acceptable safety and combustion efficiency. Use combustion analysis to evaluate the oil burner and to guide maintenance and adjustment. These procedures apply to oil-fired furnaces, boilers, and water heaters. Use other test equipment as discussed to measure



other essential operating parameters and to make adjustments as necessary.

See “*NFPA Codes*” on page 268 and “*ANSI/ACCA Manuals*” on page 268.

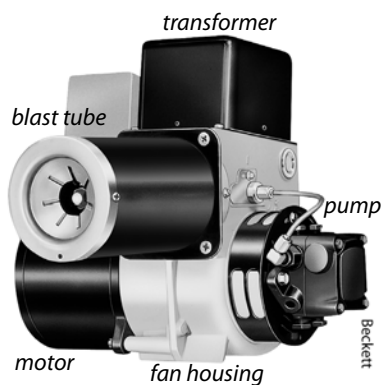

**Oil Burners:** Oil burners are power burners that atomize the oil by pumping it through a nozzle. A blower forces combustion air into the oil mist. Electrodes powered by a transformer light the mixture.

## 8.8.1 Oil Burner Testing and Adjustment

Unless the oil-fired heating unit is very dirty or disabled, technicians should do combustion testing and adjust the burner for safe and efficient operation.

### Combustion Testing and Adjustment

Combustion testing is essential to understanding the current oil burner performance and potential for improvement.

- ✓ Sample the undiluted flue gases with a smoke tester, after reading the smoke tester instructions. Compare the smoke smudge left by the gases on the filter paper with the manufacturer’s smoke-spot scale to find the smoke number.
- ✓ If the smoke number is higher than 3, take steps to reduce smoke before sampling the gases with a combustion analyzer to prevent the smoke from fouling the analyzer.
- ✓ Sample undiluted flue gases between the barometric draft control and the appliance. Analyze the flue gas for  $O_2$ ,

flue-gas temperature, CO, and steady-state efficiency (SSE).

- ✓ Measure the overfire draft over the fire inside the firebox through a plug in the heating unit.
- ✓ A flue gas temperature more than 450° F is a sign that a clean heating unit is oversized. Exceptions: steam boilers and boilers with tankless coils. If the nozzle is oversized, replace the burner nozzle after selecting the correct nozzle size, spray angle, and spray pattern.
- ✓ Adjust the barometric damper for a negative overfire draft of  $-0.020$  IWC or  $-5$  pascals at a test plug in the heating unit.
- ✓ Adjust the air shutter to achieve the oxygen and smoke values, specified in *Table 8-6 on page 317*.
- ✓ Adjust oxygen, flue-gas temperature, CO, and smoke number to match manufacturer's specifications or specifications given here. Smoke number should be near zero on all modern oil-fired equipment.

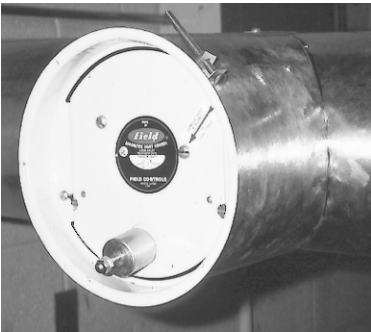

**Barometric draft control:** This control provides a stable overfire draft and controlled flow of combustion gases through the heat exchanger.

**Table 8-6: Minimum Oil Burner Combustion Standards**

<b>Oil Combustion Performance Indicator</b>	<b>Non Flame Retention</b>	<b>Flame Retention</b>
Oxygen (% O <sub>2</sub> )	4–9%	4–7%
Stack temperature (°F)	350°–600°	325°–500°
Carbon monoxide (CO) parts per million (ppm as measured)	≤200 ppm	≤ 200 ppm
Steady-state efficiency (SSE) (%)	≥ 75%	≥ 80%
Smoke number (1–9)	≤ 2	≤ 1
Excess air (%)	≤ 100%	≤ 25%
Oil pressure pounds per square inch (psi)	≥ 100 psi	≥ 100–150 psi (pmi)*
Natural-draft venting: Overfire draft (negative)	–.020 IWC or –5 Pa.	> –.020 IWC or > –5 Pa.
Positive-pressure burner with natural-draft chimney and barometric control: Over-fire draft (positive)	n/a	or 0.020 to 0.120 IWC 5 to 30 Pa. (pmi)*
Positive-pressure burner with horizontal vent and without a barometric control: Over-fire draft (positive)	n/a	or 0.20 to 0.60 IWC 50 to 150 Pa. (pmi)*
* pmi = per manufacturer’s specifications		

**Other Efficiency Testing and Adjustment**

- ✓ Adjust the gap between electrodes and their angle for proper alignment.
- ✓ Measure the control-circuit amperage. Adjust the thermostat’s heat anticipator to match the amperage, or read the thermostat manufacturer’s instructions for adjusting cycle length.

- ✓ Measure the oil-pump pressure, and adjust it to manufacturer's specifications if necessary.
- ✓ Measure the transformer voltage, and adjust it to manufacturer's specifications if necessary.
- ✓ Adjust the airflow or the water flow to reduce high flue-gas temperature if possible, but don't reduce flue-gas temperature below 350°F.

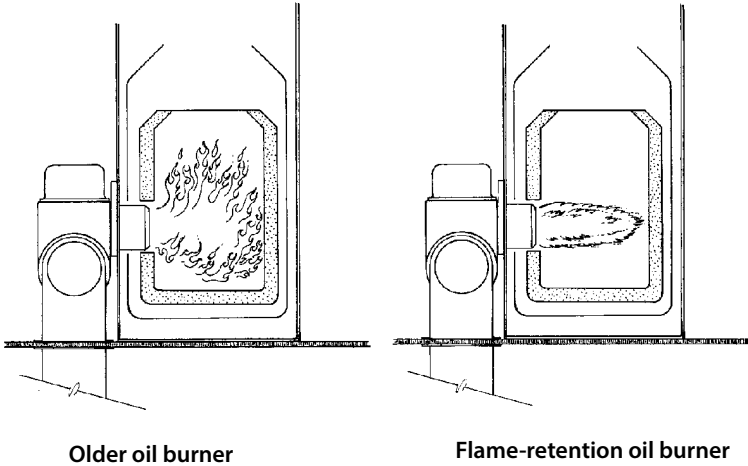

**Flame-retention burner:** The flame of a flame-retention burner is hotter and more compact than the older burner.

## 8.8.2 Oil Burner Inspection and Maintenance

Use visual inspection and combustion testing to evaluate oil burner operation. An oil burner that passes visual inspection and complies with the specifications on [page 317](#) may need no maintenance. Persistent unsatisfactory test results may indicate the need to replace the burner or the entire oil-fired heating unit.

### Safety Inspection, Testing, and Adjustment

- ✓ Inspect burner and appliance for signs of soot, overheating, fire hazards, corrosion, or wiring problems.

- ✓ Inspect heat exchanger and combustion chamber for cracks, corrosion, or soot buildup.
- ✓ If the unit smells excessively of oil, test for oil leaks and repair the leaks.
- ✓ Time the flame sensor control or stack control to verify that the burner shuts off, within either 45 seconds or a time specified by the manufacturer, when the cad cell is blocked from seeing the flame.
- ✓ Measure the high limit shut-off temperature and adjust or replace the high limit control if the shut-off temperature is more than 200° F for furnaces, or 220° F for hot-water boilers.

## Oil Burner Maintenance

After evaluating the oil burner's operation, specify some or all of these maintenance tasks as necessary, to optimize safety and efficiency.

- ✓ Clean the burner's blower wheel.
- ✓ Clean dust, dirt, and grease from the burner assembly.
- ✓ Replace oil filter(s) and nozzle.
- ✓ Clean or replace air filter.
- ✓ Remove soot from combustion chamber.
- ✓ Remove soot from heat exchange surfaces.
- ✓ Adjust gap between electrodes to manufacturer's specs.
- ✓ Check if the nozzle and the fire ring of the flame-retention burner is appropriate for the size of the combustion chamber.
- ✓ Repair the ceramic combustion chamber, or replace it if necessary.
- ✓ Verify correct flame sensor operation.

After these maintenance procedures, the technician carries out the diagnostic tests described previously to evaluate improvement made by the maintenance procedures and to determine whether more adjustment or maintenance is required.

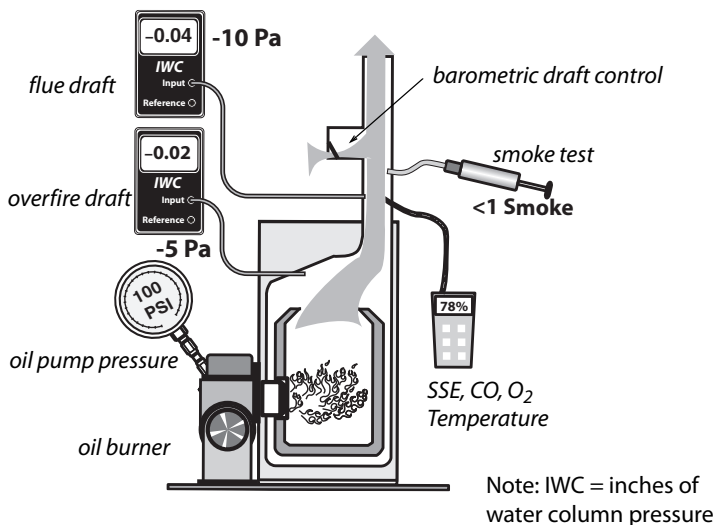

**Measuring oil-burner performance:** Measuring oil-burning performance requires, a manometer, flue-gas analyzer, smoke tester, and pressure gauge.

## 8.9 INSPECTING FURNACE HEAT EXCHANGERS

### *SWS Detail: 5.8801 Equipment Removal*

Leaks in heat exchangers are a common problem, causing the flue gases to mix with house air. Ask clients about respiratory problems, flue-like symptoms, and smells in the house when the heat is on. Also, check around supply registers for signs of soot, especially with oil heating. All furnace heat exchangers should be inspected as part of weatherization. Consider using one or more of these six options for evaluating heat exchangers.

1. Look for rust at exhaust ports and vent connectors.

2. Look for flame-impingement on the heat exchanger during firing and flame-damaged areas near the burner flame.
3. Observe flame movement, change in chimney draft, or change in CO measurement when blower is activated and deactivated.
4. Measure the flue-gas oxygen concentration before the blower starts and then again just after the blower starts. There should be no more than a 1% change in the oxygen concentration.
5. Examine the heat exchanger by shining a bright light on one side and looking for light on the other side using a mirror to look into tight locations.
6. Employ chemical detection techniques, according to the manufacturer's instructions.

*See "NFPA Codes" on page 268.*

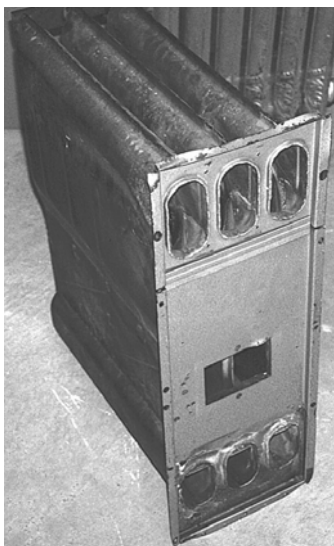

**Furnace heat exchangers:** Although no heat exchanger is completely airtight, it shouldn't leak enough to display the warning signs described here.

## 8.10 WOOD STOVES

Wood heating is a popular and effective auxiliary heating source for homes. However, wood stoves and fireplaces can cause indoor air pollution and fire hazards. Inspect wood stoves to evaluate potential hazards.

### 8.10.1 Wood Stove Clearances

Stoves that are listed by a testing agency like Underwriters Laboratory have installation instructions stating their clearance from combustibles. Unlisted stoves must adhere to clearances specified in NFPA 211.

### 8.10.2 Stove Clearances

Look for metal tags on the wood stove that list minimum clearances. Listed wood stoves may be installed to as little as 6 inches away from combustibles, if they incorporate heat shields and combustion design that directs heat away from the stove's back and sides.

Unlisted stoves must be at least 36 inches away from combustibles. Ventilated or insulated wall protectors may decrease unlisted clearance from one-third to two thirds, according to NFPA 211. Always follow the stove manufacturer's or heat-shield manufacturer's installation instructions.

#### Floor Construction and Clearances

The floor of a listed wood stove must comply with the specifications on the listing (metal tag). Modern listed stoves usually sit on a 1-inch thick non-combustible floor protector that extends 18 inches beyond the stove in front.

The floor requirements for underneath a unlisted wood stove depends on the clearance between the stove and the floor, which depends on the length of its legs. Unlisted wood stoves must have floor protection underneath them unless they rest on a



floor of non-combustible construction. An example of a non-combustible floor is one composed of only masonry material sitting on sand or gravel.

An approved floor protector is either one or two courses of hollow masonry material (4 inches thick) with a non-combustible quarter-inch surface of steel or other non-combustible material on top of the masonry. This floor for a non-listed wood stove must extend no less than 18 inches beyond the stove in all directions.

### Vent-Connector and Chimney Clearance

Interior masonry chimneys require a 2-inch clearance from combustibles and exterior masonry chimneys require a 1-inch clearance from combustibles. All-fuel metal chimneys (insulated double-wall or triple wall) usually require a 2-inch clearance from combustibles.

Double-wall stove-pipe vent connectors require a 9-inch clearance from combustibles or a clearance listed on the product. Single wall vent connectors must be at least 18 inches from combustibles. Wall protectors may reduce this clearance up to two-thirds.

See also *“Wood Stove Clearances” on page 322* and *“Stove Clearances” on page 322*.

### 8.10.3 Wood Stove Inspection

All components of wood stove venting systems should be approved for use with wood stoves. Chimney sections penetrating floor, ceiling, or roof should have approved thimbles, support packages, and ventilated shields to protect nearby combustible materials from high temperatures. Perform or specify the following inspection tasks.

- ✓ Inspect stove, vent connector, and chimney for correct clearances from combustible materials as listed on stoves and vent assemblies or as specified in NFPA 211.

- ✓ Each wood stove must have its own dedicated flue pipe. Two wood stoves may not share a single flue.
- ✓ If the home is tight ( $<0.35$  ACH), the wood stove should be equipped with a dedicated outdoor combustion-air duct.
- ✓ Inspect vent connector and chimney for leaks. Leaks should be sealed with a high temperature sealant designed for sealing wood stove vents.
- ✓ Galvanized-steel pipe must not be used to vent wood stoves.
- ✓ Inspect chimney and vent connector for creosote build-up, and suggest chimney cleaning if creosote build-up exists.
- ✓ Inspect the house for soot on seldom-cleaned horizontal surfaces. If soot is present, inspect the wood stove door gasket. Seal stove air leaks or chimney air leaks with stove cement. Improve draft by extending the chimney to reduce indoor smoke emissions.
- ✓ Inspect stack damper and/or combustion air intake damper.
- ✓ Check catalytic converter for repair or replacement if the wood stove has one.
- ✓ Assure that heat exchange surfaces and flue passages within the wood stove are free of accumulations of soot or debris.
- ✓ Wood stoves installed in manufactured homes must be approved for use in manufactured homes.

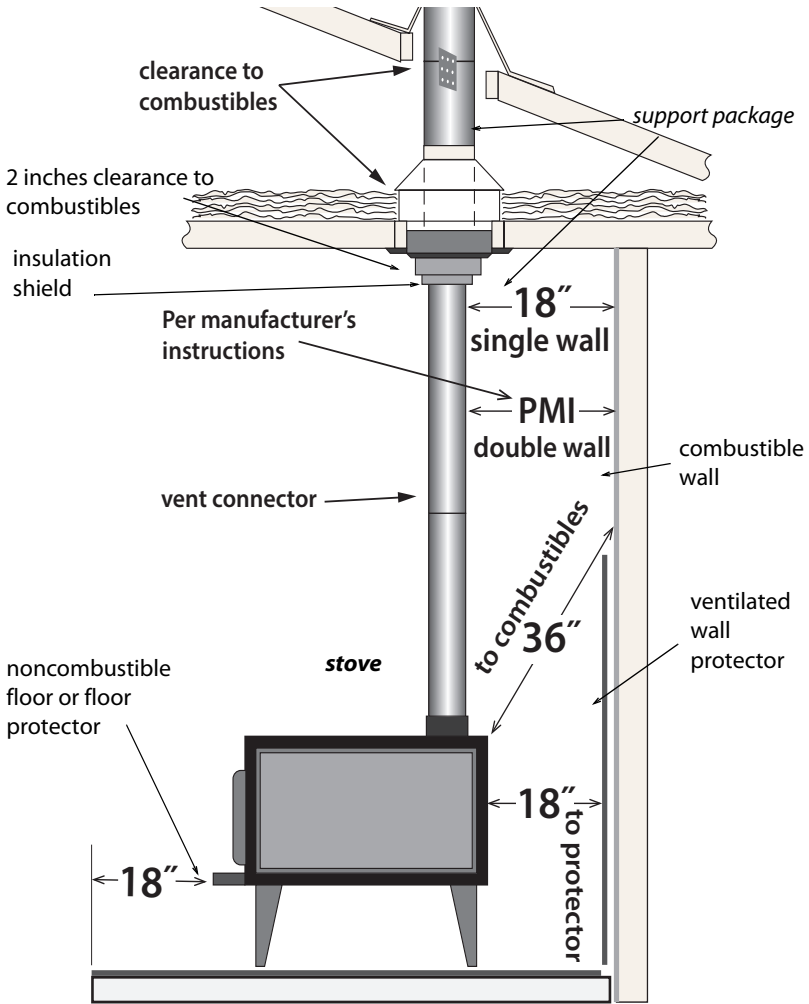

**Wood-stove installation:** Wood-stove venting and clearances are vitally important for wood-burning safety. Read manufacturer's instructions for the stove and its venting components.

## 8.11 INSPECTING VENTING SYSTEMS

*SWS Detail: 5.0503 Appliance Venting; 5.0503.1 Fuel-Fired Appliance Venting; 5.0501 Combustion Appliance Zones*

Combustion gases are vented through vertical chimneys or other types of approved horizontal or vertical vent piping. Identifying the type of existing venting material, verifying the correct size of vent piping, and making sure the venting conforms to the applicable codes are important tasks in inspecting and repairing venting systems. Too large a vent often leads to condensation and corrosion. Too small a vent can result in spillage. The wrong vent materials can corrode or deteriorate from heat.

*See “NFPA Codes” on page 268.*

### 8.11.1 Vent Connectors

A vent connector connects the appliance’s venting outlet collar with the chimney. Approved vent connectors for gas-fired units are made from the following materials.

- Type-B vent, consisting of a galvanized steel outer pipe and aluminum inner pipe for gas-fired units.
- Type-L vent connector with a stainless-steel inner pipe and a galvanized-steel outer pipe for oil-fired units.
- Double-wall stove-pipe vent connector with a stainless-steel inner pipe and a black-steel outer pipe for solid-fuel units.
- Galvanized steel pipe for gas or oil-fired units only: *See table.*

**Table 8-7: Single-Wall Galvanized Vent Connector Thickness**

<b>Diameter of Vent Connector (inches)</b>	<b>Inches (gauge)</b>
5 and smaller	0.022 (26 gauge)
6 to 10	0.028 (24 gauge)
11 to 16	0.034 (22 gauge)
Larger than 16	0.064 (16 gauge)

From *International Mechanical Code 2009*

Double-wall vent connectors are the best option, especially for appliances with some non-vertical vent piping. A double-wall vent connector maintains flue gas temperature and prevents condensation. Gas appliances with draft hoods, installed in attics or crawl spaces must use a Type-B vent connector. Use Type-L double-wall vent pipe for oil vent connectors in attics and crawl spaces.

### Vent-Connector Requirements

Verify that vent connectors comply with these specifications.

- Vent connectors must be as large as the vent collar on the appliances they vent.
- Single wall vent-pipe sections must be fastened together with 3 screws or rivets.
- Vent connectors must be sealed tightly where they enter masonry chimneys.
- Vent connectors must be free of rust, corrosion, and holes.
- Maintain minimum clearances between vent connectors and combustibles.

**Table 8-8: Clearances to Combustibles for Vent Connectors**

Vent Connector Type	Clearance
Single wall galvanized steel vent pipe	6" (gas), 18" (oil)
Type-B double wall vent pipe (gas)	1" (gas)
Type L double wall vent pipe	3" or as listed (oil)
Single-wall stove pipe	18" (wood)
Double-wall stove pipe	9" or as listed (wood)

- The chimney combining two draft-hood vent connectors must have a cross-sectional area equal to the area of the larger vent connector plus half the area of the smaller vent connector. This common vent must be no larger than 7 times the area of the smallest vent connector. For specific vent sizes, see the NFPA codes listed on [page 326](#).

**Table 8-9: Areas of Round Vents**

Vent diameter	4"	5"	6"	7"	8"
Vent area (square inches)	12.6	19.6	28.3	38.5	50.2

- The horizontal length of vent connectors shouldn't be more than 75% of the chimney's vertical height or have more than 18 inches horizontal run per inch of vent diameter.
- Vent connectors must have upward slope to their connection with the chimney. NFPA 54 requires a slope of at least 1/4-inch of rise per foot of horizontal run so that combustion gases rise through the vent. The slope also prevents condensation from collecting in the vent and corroding it.

**Table 8-10: Connector Diameter vs. Maximum Horizontal Length**

Diam (in)	3"	4"	5"	6"	7"	8"	9"	10"	12"	14"
Length (ft)	4.5'	6'	7.5'	9'	10.5'	12'	13.5'	15'	18'	21'

From *International Fuel Gas Code 2000*

- When two vent connectors connect to a single chimney, the vent connector servicing the smaller appliance must enter the chimney above the vent for the larger appliance.

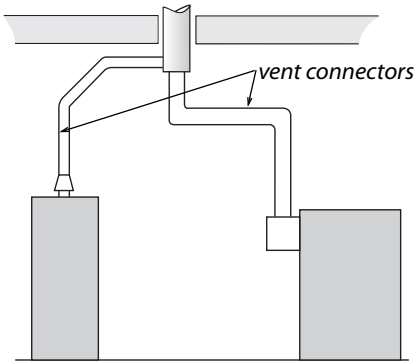

**Two vent connectors joining chimney:** The water heater's vent connector enters the chimney above the furnace because the water heater has a smaller input.

## 8.12 CHIMNEYS

*SWS Detail: 5.0503 Appliance Venting; 5.0503.1 Fuel-Fired Appliance Venting*

There are two common types of vertical chimneys for venting combustion fuels that satisfy NFPA and ICC codes. First there are masonry chimneys lined with fire-clay tile, and second there are manufactured metal chimneys, including all-fuel metal chimneys, Type-B vent chimneys for gas appliances, and Type L chimneys for oil appliances.

*See "NFPA Codes" on page 268.*

### 8.12.1 Masonry Chimneys

*SWS Detail: 5.0503.1 Fuel-Fired Appliance Venting*

Verify the following general specifications for building, inspecting, and repairing masonry chimneys.

- A masonry foundation should support every masonry chimney.

- Existing masonry chimneys should be lined with a fire clay flue liner. There should be a  $\frac{1}{2}$ -inch to 1-inch air gap between the clay liner and the chimney's masonry to insulate the liner. The liner shouldn't bond structurally to the outer masonry because the liner needs to expand and contract independently of the chimney's masonry structure. The clay liner can be sealed to the chimney cap with a flexible high-temperature sealant.

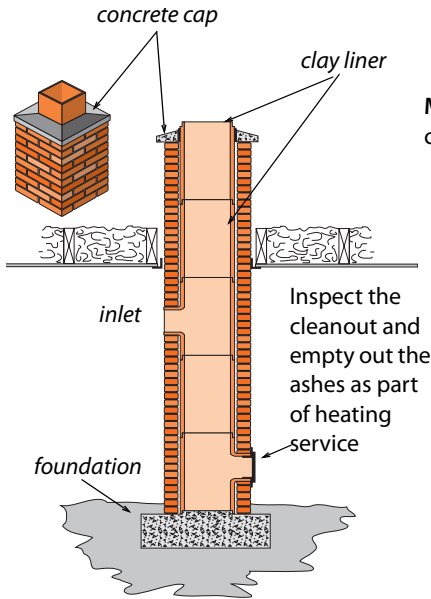

**Masonry chimneys:** Remain a very common vent for all fuels.

- Masonry chimneys should have a cleanout 12 inches or more below the lowest inlet. Clean mortar and brick dust out of the bottom of the chimney through the clean-out door, so that this debris won't eventually interfere with venting.
- Seal the chimney's penetrations through floors and ceilings with sheet metal and high-temperature sealant as a fire-stop and air barrier.
- Re-build deteriorated or unlined masonry chimneys as specified above or reline them as part of a heating-system replacement or a venting-safety upgrade. Or, install a new



metal chimney instead of repairing the existing masonry chimney.

## Metal Liners for Masonry Chimneys

Install or replace liners in unlined masonry chimneys or chimneys with deteriorated liners as part of heating system replacement. Orphaned water heaters may also need a chimney liner because the existing chimney may be too large. Use a correctly sized Type-B vent, a flexible or rigid stainless-steel liner, or a flexible aluminum liner.

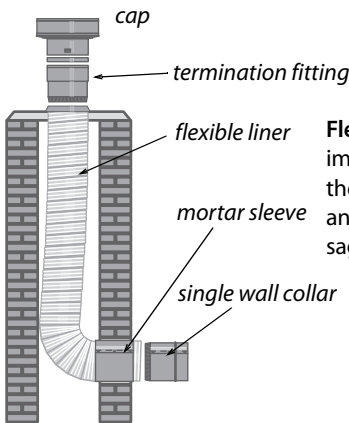

**Flexible metal chimney liners:** The most important installation issues are sizing the liner correctly along with fastening and supporting the ends to prevent sagging.

Flexible liners require careful installation to avoid a low spot at the bottom, where the liner turns a right angle to pass through the wall of the chimney. Comply with the manufacturer's instructions, which usually require stretching the liner and fastening it securely at both ends, to prevent the liner from sagging and creating a low spot.

Flexible liners are easily damaged by falling masonry debris inside a deteriorating chimney. Use B-vent, L-vent, or single-wall stainless steel pipe instead of a flexible liner when the chimney is significantly deteriorated.

To minimize condensation, insulate the flexible liner — especially when installed in exterior chimneys. Consider fiberglass-

insulation jackets or perlite, if the manufacturer's instructions allow. Wood-stove chimney liners must be stainless steel and insulated.

Sizing flexible chimney liners correctly is very important. Oversizing is common and can lead to condensation and corrosion. The manufacturers of the liners include vent-sizing tables in their specifications. Liners should display a label from a testing lab like Underwriters Laboratories (UL).

**Masonry chimneys as structural hazards:** A building owner may want to consider reinforcing a deteriorated chimney by re-pointing masonry joints or parging the surface with reinforced plaster. Other options include demolishing the chimney or filling it with concrete to prevent it from damaging the building by collapsing during an earthquake.



**Video: Natural drafting chimneys**— Discussion about the various type of appliances that use atmospheric chimneys.

## Solutions for Failed Chimneys

Sometimes a chimney is too deteriorated to be re-lined or repaired. In this case, abandon the old chimney, and install one of the following.

- A double-wall horizontal sidewall vent, equipped with a barometric draft control and a power venter mounted on the exterior wall. Maintain a 4-foot clearance between the ground and the vent's termination if you live where it snows.
- A new heating unit, equipped with a power burner or draft inducer, that is designed for horizontal or vertical venting.
- A new manufactured metal venting system.

**Table 8-11: Clearances to Combustibles for Common Chimneys**

Chimney Type	Clearance
Interior chimney masonry w/ fireclay liner	2"
Exterior masonry chimney w/ fireclay liner	1"
All-fuel metal vent: insulated double-wall or triple-wall pipe	2"
Type B double-wall vent (gas only)	1"
Type L double-wall vent (oil)	3"
Manufactured chimneys and vents list their clearances.	

### 8.12.2 Manufactured Chimneys

*SWS Detail: 5.0503.1 Fuel-Fired Appliance Venting*

Manufactured metal chimneys have engineered parts that fit together in a prescribed way. Parts include: metal pipe, weight-supporting hardware, insulation shields, roof jacks, and chimney caps. One manufacturer’s chimney may not be compatible with another’s connective fittings.

All-fuel chimneys (also called Class A chimneys) are used primarily for the solid fuels: wood and coal. All-fuel metal chimneys come in two types: insulated double-wall metal pipe and triple-wall metal pipe. Comply with the manufacturer’s specifications when you install these chimneys.



**All-fuel metal chimney:** These chimney systems include transition fittings, support brackets, roof jacks, and chimney caps. The pipe is double-wall insulated or triple-wall construction.



Type-B vent double-wall pipe is permitted as a chimney for gas appliances. Type BW pipe is manufactured for gas space heaters in an oval shape to fit inside wall cavities.

Type L double-wall pipe is used for oil chimneys.

### 8.12.3 Chimney Terminations

#### *SWS Detail: 5.0503.1 Fuel-Fired Appliance Venting*

Masonry chimneys and all-fuel metal chimneys should terminate at least three feet above the roof penetration and two feet above any obstacle within ten feet of the chimney outlet.

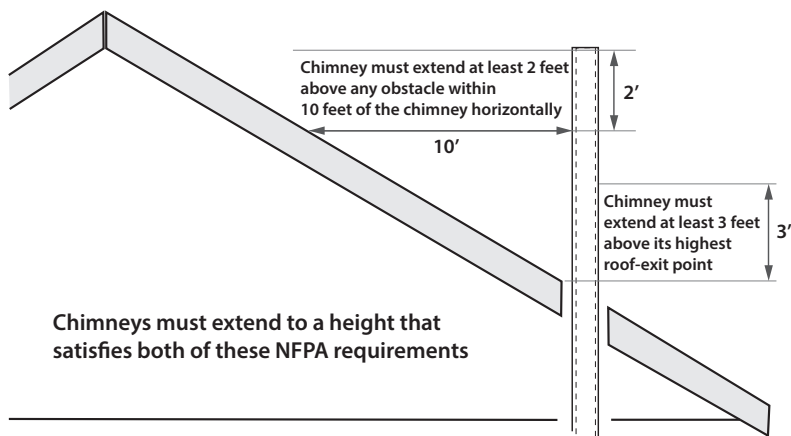

**Chimney terminations:** Should have vent caps and be given adequate clearance height from nearby building parts. These requirements are for both masonry chimneys and manufactured all-fuel chimneys.

B-vent chimneys can terminate as close as one foot above flat roofs and above pitched roofs up to a  $\frac{6}{12}$  roof pitch. As the pitch rises, the minimum required termination height, as measured from the high part of the roof slope, rises as shown in this table.

**Table 8-12: Roof Slope and B-Vent Chimney Height (ft)**

flat- 6/12	6/12- 7/12	7/12- 8/12	8/12- 9/12	9/12- 10/12	10/12- 11/12	11/12- 12/12	12/12- 14/12	14/12- 16/12	16/12- 18/12
1'	1' 3"	1' 6"	2'	2' 6"	3' 3"	4'	5'	6'	7'

From *National Fuel Gas Code 2009*

---

### 8.12.4 Air Leakage through Masonry Chimneys

The existing fireplace damper or “airtight” doors seldom provide a good air seal. Help the clients decide whether they will use the fireplace in the future or whether to take it out of service. Consider these solutions for chimneys with ineffective or missing dampers.

- Install an inflatable chimney seal along with a notice of its installation to alert anyone wanting to start a fire to remove the seal first.
- Install an operable chimney-top damper and leave instructions on how to open and close it. Also notify users of which position is open and which is closed.
- Air seal the chimney top from the roof with a watertight, airtight seal. Also seal the chimney from the living space with foam board and drywall. If you install a permanent chimney seal such as this, post a notice at the fireplace saying that it is permanently disabled.

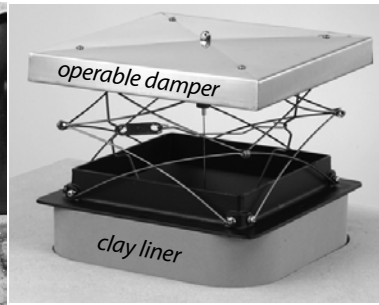

**Reducing air leakage through masonry chimneys:** You can seal a chimney off permanently, install an inflatable seal inside, or install a chimney-top damper from the outside to reduce air leakage through the chimney.

## 8.13 SPECIAL VENTING CONSIDERATIONS FOR GAS

The American Gas Association (AGA) publishes a classification system for venting systems attached to natural-gas and propane appliances. This classification system assigns Roman numerals to four categories of venting based on whether there is positive or negative pressure in the vent and whether condensation is likely to occur in the vent.

**AGA venting categories:**  
The AGA classifies venting by whether there is positive or negative pressure in the vent and whether condensation is likely.

	Negative-pressure Venting	Positive-pressure
Non-condensing	<p>I</p> <p>Combustion Efficiency <b>83% or less</b></p> <p>Use standard venting: masonry or Type B vent</p>	<p>III</p> <p>Combustion Efficiency <b>83% or less</b></p> <p>Use only pressurizable vent as specified by manufacturer</p>
Condensing	<p>II</p> <p>Combustion Efficiency <b>over 83%</b></p> <p>Use only special condensing-service vent as specified by manufacturer</p>	<p>IV</p> <p>Combustion Efficiency <b>over 87%</b></p> <p>Use only pressurizable condensing-service vent as specified by manufacturer</p>
American Gas Association Vent Categories		

A majority of gas appliances found in homes and multifamily buildings are Category I, which have negative pressure in their vertical chimneys. We expect no condensation in the vent connector or chimney.

Condensing furnaces are usually Category IV, have positive pressure in their vent, and condensation occurring in both the appliance and vent. Category III vents are rare, however a few fan-assisted furnaces and boilers vent their flue gases through airtight non-condensing vents. Category II vents are very rare and beyond the scope of this discussion.

### 8.13.1 Venting Fan-Assisted Furnaces and Boilers

*SWS Detail: 5.0503.1 Fuel-Fired Appliance Venting*

Newer gas-fired fan-assisted central furnaces and boilers eliminate dilution air and may have slightly cooler flue gases compared to their predecessors. The chimney may experience more condensation than in the past. Inspect the existing chimney to verify that it's in good condition when considering replacing an

old natural-draft unit. Reline the chimney when you see any of these conditions.

- When the existing masonry chimney is unlined.
- When the old clay or metal chimney liner is deteriorated.
- When the new furnace has a smaller input (BTUH) than the old one, the liner should be sized to the new furnace and the existing water heater.

**B-vent chimney liner:** Double wall Type-B vent is the most commonly available chimney liner and is recommended over flexible liners. Rigid stainless-steel single wall liners are also a permanent solution to deteriorated chimneys.

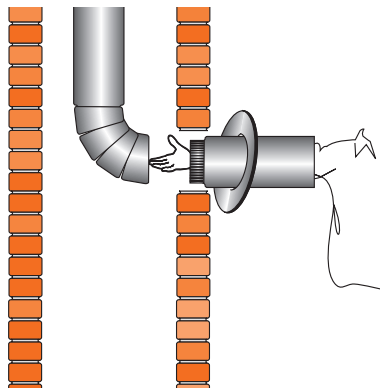

### Liner Materials for 80+ Furnaces

For gas-fired 80+ AFUE furnaces, a chimney liner should consist of one of these four materials.

1. A type-B vent
2. A rigid or flexible stainless steel liner (preferably insulated)
3. A poured masonry liner
4. An insulated flexible aluminum liner

Chimney relining is expensive. Therefore consider a power-vented sealed-combustion unit when an existing chimney is inadequate for a new fan-assisted appliance.



## 8.13.2 Venting Sealed-Combustion Furnaces and Boilers

### *SWS Detail: 5.0503.1 Fuel-Fired Appliance Venting*

Some space heaters, furnaces, and boilers use factory-built metal chimneys with single stainless steel liners that vent horizontally under positive pressure.

Condensing furnaces usually employ horizontal or vertical plastic-pipe chimneys.

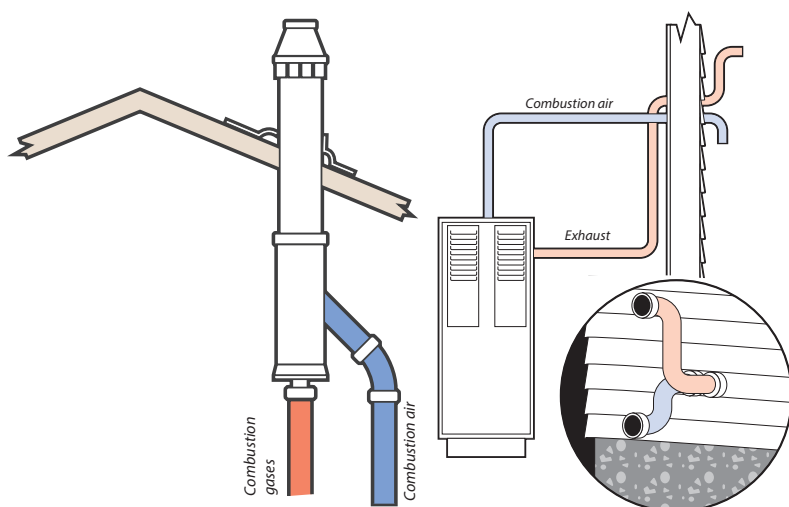

**Two types of sealed-combustion vents:** On the left is a concentric vent exiting through a roof. On the right is a plastic-pipe vent and combustion-air opens through the wall.

## 8.13.3 Sidewall Power Venting

### *SWS Detail: 5.0503.1 Fuel-Fired Appliance Venting*

Stainless-steel vents powered by fans in gas and oil appliances exit through walls and don't require vertical chimneys.

**Table 8-13: Characteristics of Gas Furnaces and Boilers**

<b>Annual Fuel Utilization Efficiency (AFUE)</b>	<b>Operating characteristics</b>
70+	Category I, draft diverter, no draft fan, standing pilot, non-condensing, indoor combustion and dilution air.
80+	Category I, no draft diverter, fan-assisted draft, electronic ignition, indoor combustion air, no dilution air.
80+	Category III, horizontal fan-pressurized non-condensing vent, indoor combustion air, no dilution air.
90+	Category IV, no draft diverter, fan-assisted draft, low-temperature plastic venting, positive draft, electronic ignition, condensing heat exchanger, outdoor combustion air is strongly recommended.

## 8.14 DUCTED AIR DISTRIBUTION

*SWS Detail: 5.01 Forced Air; 5.0101 Controls; 5.0104 Duct Installation; 5.0105 Duct Repair; 5.0106 Duct Sealing; 5.0107 Duct Insulation*

The forced-air system consists of an air handler (furnace, heat pump, air conditioner) with its heat exchanger along with attached ducts. The annual system efficiency of forced-air heating and air-conditioning systems depends on the following issues.

- Duct leakage
- System airflow
- Blower operation
- Balance between supply and return air
- Duct insulation levels

See [“NFPA Codes” on page 268](#) and [“ANSI/ACCA Manuals” on page 268](#).



**Video: Duct energy efficiency**— An overview of the elements that make up and affect the energy efficiency of duct systems.

### 8.14.1 Sequence of Duct Improvements

The evaluation and improvement of ducts has a logical sequence of steps.

- ✓ Solve the airflow problems because a contractor might have to replace ducts or install additional ducts, which would possibly waste your efforts at retrofitting.
- ✓ Determine whether the ducts are located inside the thermal boundary or outside it.

- ✓ Evaluate the ducts' air leakage, and decide whether duct-sealing is important and if so, find and seal the duct leaks.
- ✓ If supply ducts are outside the thermal boundary or if condensation is an air-conditioning problem, insulate the ducts.

## 8.14.2 Solving Airflow Problems

*SWS Detail: 5.0104 Duct Installation; 5.0105 Duct Repair; 5.0106 Duct Sealing; 5.0107 Duct Insulation*

You don't need test instruments to discover dirty blowers or disconnected branch ducts. Find these problems before measuring duct airflow, troubleshooting the ducts, or sealing the ducts. These steps precede airflow measurements.

1. Ask the client about comfort problems and temperature differences in different rooms of the home.
2. Based on the clients comments, look for disconnected ducts, restricted ducts, and other obvious problems.
3. Inspect the filter(s), blower, and indoor coil for dirt. Clean them if necessary. If the indoor coil isn't easily visible, a dirty blower means that the coil is probably also dirty.
4. Look for dirty or damaged supply and return grilles that restrict airflow. Clean and repair them.
5. Look for closed registers or closed balancing dampers that could be restricting airflow to uncomfortable rooms.
6. Notice moisture problems like mold and mildew. Moisture sources, like a wet crawl space, can overpower air conditioners by introducing more moisture into the air than the air conditioner can remove.

## Measuring Total External Static Pressure (TESP)

The blower creates the duct pressure, which is measured in inches of water column (IWC) or pascals. The return static pressure is negative and the supply static pressure is positive. Total external static pressure (TESP) is the sum of the absolute values of the supply and return static pressures. Absolute value means that you ignore the positive or negative signs when adding supply static pressure and return static pressure to get TESP. This addition represents the distance on a number line as shown in the illustration here.

**TESP number line:** the TESP represents the distance on a number line between the return and supply ducts.

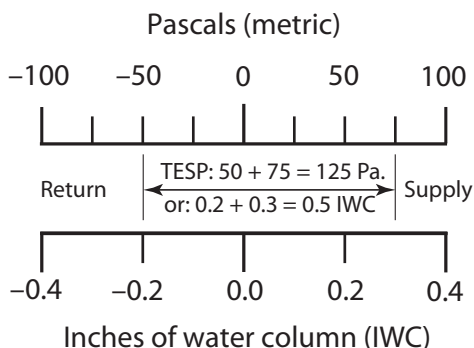

TESP gives a rough indicator of whether airflow is adequate. The greater the TESP, the less the airflow. The supply and return static pressures by themselves can indicate whether the supply or the return or both sides are restricted. For example, if the supply static pressure is 0.10 IWC (25 pascals) and the return static pressure is -0.5 IWC (-125 pascals), you can assume that most of the airflow problems are due to a restricted or undersized return. The TESP give a rough estimate of airflow if the manufacturer's graph or table for static pressure versus airflow is available.

1. Attach two static pressure probes to tubes leading to the two ports of the manometer. Attach the high-side port to the probe inserted downstream of the air handler in the supply duct. The other tube goes upstream of the air

handler in the return duct. The manometer adds the supply and return static pressures to measure TESP.

2. Consult manufacturer's literature for a table of TESP versus airflow for the blower or the air handler. Find airflow for the TESP measured in Step 1.
3. Measure pressure on each side of the air handler to obtain both supply and return static pressures separately. This test helps to locate the main problems as related to either the supply or the return.

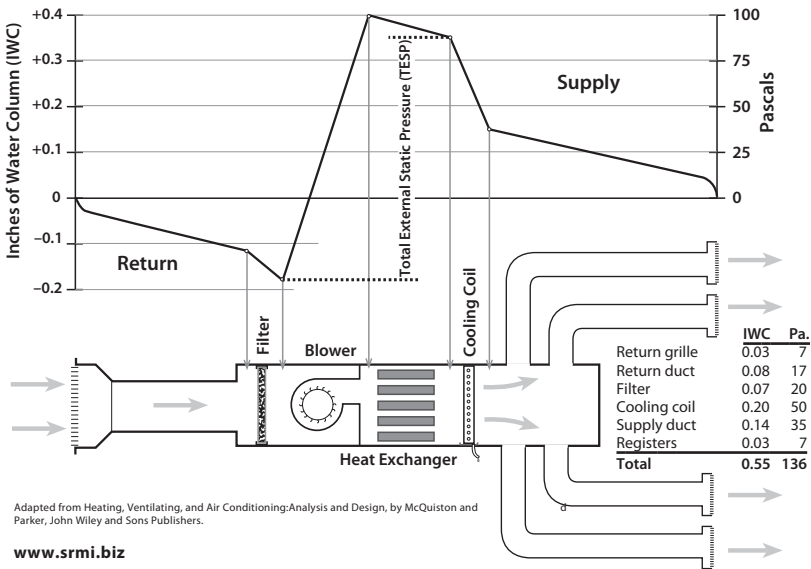

**Visualizing TESP:** The blower creates a suction at its inlet and a positive pressure at its outlet. As the distance between the measurement and blower increase, pressure decreases because of the system's lower resistance.

### Static Pressure Guidelines

Air handlers deliver their airflow at TESP's ranging from 0.30 IWC (75 Pascals) to 1.0 IWC (250 Pascals) as found in the field. Manufacturer's recommended static pressure is usually a maximum 0.50 IWC (125 pascals) for standard air handlers. TESP's

greater than 0.50 IWC indicate inadequate airflow in standard residential forced-air systems.

The popularity of pleated filters, electrostatic filters, and high-static high-efficiency evaporator coils, prompted manufacturers to introduce premium air handlers that can deliver adequate airflow at a TESP of greater than 0.50 IWC (125 pascals). Premium residential air handlers can provide adequate airflow with TESP of up to 0.90 IWC (225 pascals) because of their more powerful blowers and variable-speed blowers. TESP greater than 0.90 IWC indicate the possibility of inadequate airflow in these premium residential forced-air systems.

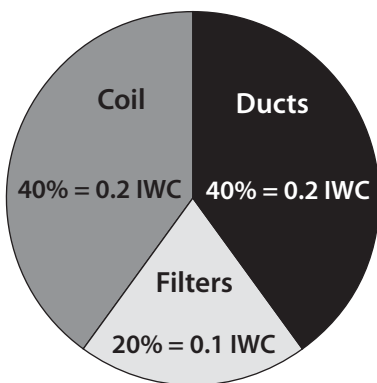

**Static pressure budget:** Typical static pressures in IWC and % for a marginally effective duct system.

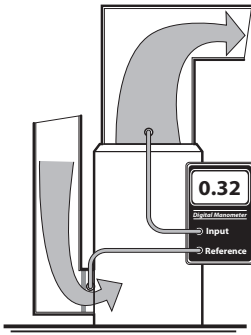

**Total external static pressure (TESP):**  
 The positive and negative pressures created by the resistance of the supply and return ducts produces TESP. The measurement shown here simply adds the two static pressures without regard for their signs. As TESP increases, airflow decreases. Numbers shown below are for example only.

**Table 8-14: Total External Static Pressure Versus System Airflow for a Particular System**

<b>TESP (IWC)</b>	0.30	0.40	0.50	0.60	0.70	0.80
<b>CFM</b>	995	945	895	840	760	670

*Example only*

### 8.14.3 Unbalanced Supply-Return Airflow Test

Closing interior doors often separates supply registers from return registers in homes with central returns. A bedroom door with no return register and a closed door restricts the bedroom air from returning to the air handler. This restriction pressurizes bedrooms and depressurizes the central areas near return registers. These pressures can drive air leakage through the building envelope, create moisture problems, and bring pollutants in from the crawl space, garage, or CAZ.

The following test uses only the air handler and a digital manometer to evaluate whether the supply air can flow back to the return registers relatively unobstructed. Activate the air handler and close interior doors.

1. Measure the pressure difference between the home's central living area and the outdoors with a digital manometer.



2. Measure the bedrooms' pressure difference with reference to outdoors.

If the sum of these two measurements is more than 3.0 pascals with the air handler operating, consider pressure relief.

- Like TESP, disregard the positive or negative signs, and add the absolute values.
- Or instead, you can measure the pressure difference between the central zone and the bedroom as shown in the next illustration.

To estimate the amount of pressure relief needed, slowly open the bedroom door until the pressure difference drops below 1 pascal.

Estimate the surface area of that door opening. This is the area of the permanent opening required to provide pressure relief. Pressure relief may include undercutting the door, installing transfer grilles, or installing jumper ducts.



**Video: Unbalanced duct airflow**— A discussion about how unbalanced duct airflow pressurizes and depressurizes different parts of the building.



**Video: Duct leakage and house pressures**— An explanation of how duct leakage pressurizes the building.

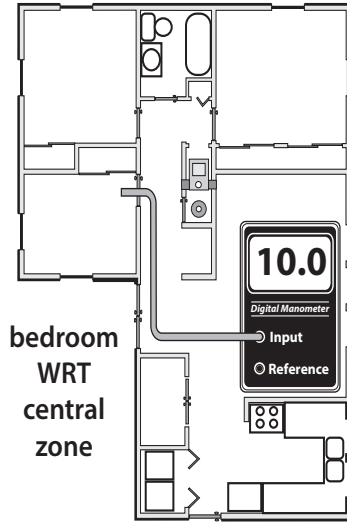
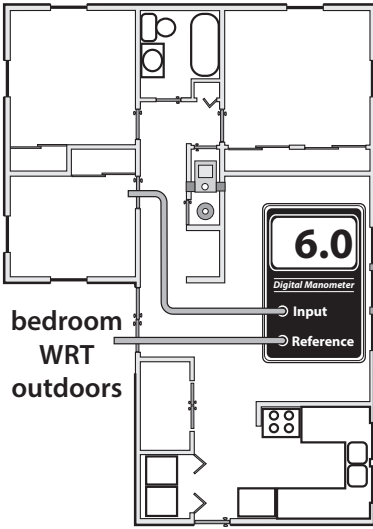

**Pressurized bedrooms:** Bedrooms with supply registers but no return register are pressurized when the air handler is on and the doors are closed. Pressures this high can double or triple air leakage through the building envelope.

**Pressure difference bedroom to central zone:** The air handler depressurizes the central zone and pressurizes the bedroom, when the bedroom doors are closed. This test measures the pressure difference.

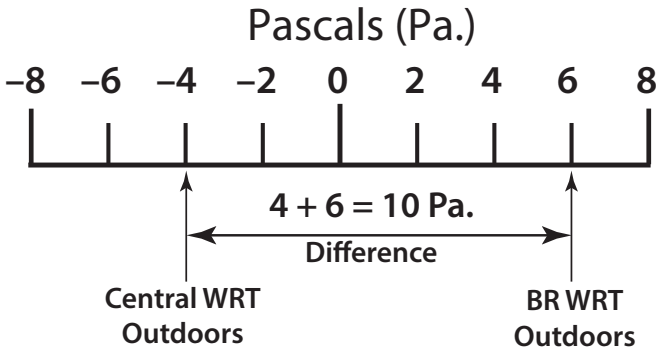

**Measuring unbalanced airflow:** The distance on a number line represents the difference in pressure between the central zone and the bedroom.

## 8.14.4 Evaluating Furnace Performance

### *SWS Detail: 5.0108.4 Furnaces*

The effectiveness of a furnace depends on its temperature rise, fan-control temperatures, and flue-gas temperature. For efficiency, you want a low temperature rise. However, you must maintain a minimum flue-gas temperature to prevent corrosion in the venting of 70+ and 80+ AFUE furnaces. Apply the following furnace-operation standards to maximize the heating system's seasonal efficiency and safety.

- ✓ Perform a combustion analysis as described in *“Gas Burner Safety & Efficiency Service” on page 311*.
- ✓ Check temperature rise after 5 minutes of operation. Refer to manufacturer's nameplate for acceptable temperature rise (supply temperature minus return temperature). The temperature rise should be the minimum and maximum temperature rise on the nameplate (usually 40°F and 70°F). Prefer the lower end of this range for energy efficiency.
- ✓ With temperature-activated controls, verify that the fan-on temperature is 120–140° F. The lower the better.
- ✓ With time-activated fan controls, verify that the fan is switched on with the shortest time delay available if it is adjustable. The appliance should be switched off with the time delay that achieves a fan off temperature of 20° to 30° above the measured return-air temperature.
- ✓ Verify that the high limit controller shuts the burner off before the furnace temperature reaches 200°F.

**Table 8-14: Furnace Operating Parameters**

Inadequate temperature rise: condensation and corrosion possible.	Temperature rise OK for both efficiency and avoidance of condensation.	Temperature is excessive: Check fan speed, heat exchanger and ducts.
<b>20°</b>	<b>45°</b>	<b>70°</b>
<b>Temperature Rise = Supply Temperature – Return Temperature</b>		

Excellent fan-off temperature if comfort is acceptable.	Borderline acceptable: Consider replacing fan control.	Unacceptable range: Significant savings possible by adjusting or replacing fan control.
<b>85°</b>	<b>100°</b>	<b>115°</b>
<b>Fan-off Temperature</b>		

Excellent fan-on temperature range: No change needed.	Fair: Consider fan-control replacement if fan-off temperature is also borderline.	Poor: Adjust or replace fan control.
<b>100°</b>	<b>120°</b>	<b>140°</b>
<b>Fan-on Temperature</b>		

- ✓ Verify that there is a strong noticeable airflow from all supply registers.
- ✓ Adjust fan control to conform to these standards, or replace the fan control if adjustment fails. Some fan controls aren't adjustable.
- ✓ Adjust the high limit control to conform to the above standards, or replace the high limit control.
- ✓ All forced-air heating systems must deliver supply air and collect return air only from inside the intentionally heated portion of the house. Taking return air from an un-heated area of the house such as an unconditioned basement or a crawl space isn't acceptable.

### 8.14.5 Recommended Airflow for Air Handlers

The air handler's recommended airflow depends on its heating or cooling capacity. For combustion furnaces, provide 11-to-15 cfm of airflow for each 1000 BTUH of output. Verify at least 2 square inches of cross-sectional area for each 1000 BTUH of furnace input in both the supply plenum and the return plenum in order to achieve this airflow.

Central air conditioners and heat pumps should deliver 400 cfm  $\pm$ 20% of airflow per ton of cooling capacity (one ton equals 12,000 BTUH). This airflow standard typically requires a duct system with at least 6 square inches of cross-sectional area of both supply plenum and return plenum, connected to the air handler, for each 1000 BTUH of air-conditioning or heat-pump capacity.

### 8.14.6 Rooftop Units (Air Handlers)

Rooftop units (RTUs) are air handlers located on roofs or on slabs or platforms outdoors. RTUs may contain one or more of the following.

- A combustion furnace
- All the components of an air conditioner (packaged or unitary air conditioner)
- All the components of an heat pump (packaged or unitary heat pump)
- Outdoor-air damper with another damper, called an economizer for ventilation and free cooling.

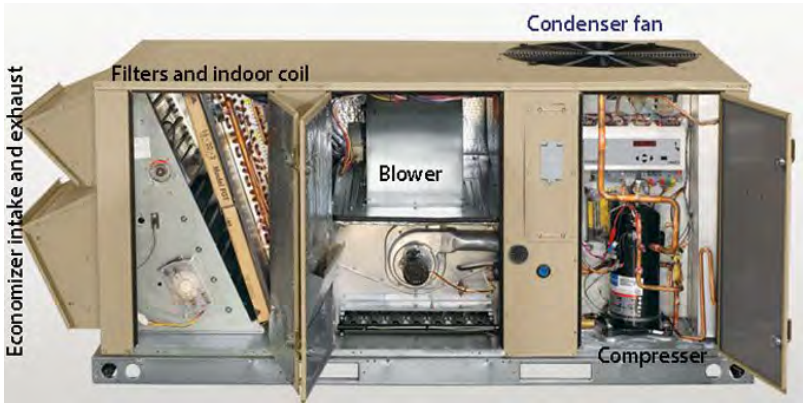

**Rooftop Unit:** HVAC manufacturers and dealers classify RTUs as unitary or packaged central HVAC systems. They may contain all the components for heating, cooling, and ventilation.

## Economizers

A controller in the economizer measures the temperature (and humidity in humid climates) of the outdoor air. When the outdoor conditions are favorable, the control switches the air conditioning compressor off and cools the building with outdoor air instead. The economizer uses far less cooling energy compared to air conditioning.

Economizers typically operate at night when the outdoor air is cooler than the indoor air in a process known as “free cooling”. Economizers mix enough outdoor air into the indoor air in order to meet the thermostat setpoint (which may be lower than the AC setpoint), without using the compressor.

Fresh air that economizers exchange with indoor air while they save cooling energy at night can also count as ventilation. Therefore the ventilation system can run for fewer hours and avoid operating during the day’s peak electrical load.

## RTU Maintenance and Improvement

Because RTUs are located outdoors, they are even more likely to be neglected compared to indoor air handlers. Fortunately

though, the RTU's components are more accessible compared to indoor air handlers.

Consider the following maintenance and improvements for RTUs.

- ✓ Clean or change filters, provide extra filters, and educate the building owner on filter maintenance.
- ✓ Test the combustion furnace as you would an indoor furnace. *See “Electronic Combustion Analysis” on page 291.*
- ✓ Clean the evaporator and condenser coils as specified on *page 401.*
- ✓ Test the RTU and its ducts for air leakage because many RTUs systems have high duct leakage. *See “Evaluating Duct Air Leakage” on page 359.*
- ✓ Test and adjust the economizer to maximize its benefit for both free cooling and ventilation. **This requires an elite HVAC controls technician.**
- ✓ Educate the building owner or operator on economizer function and control. Replace the thermostat, if necessary to accommodate optimal economizer functioning. **Note: Economizers functioning isn't intuitive and therefore many, if not most, economizers function poorly.**

# Troubleshooting Temperature Rise

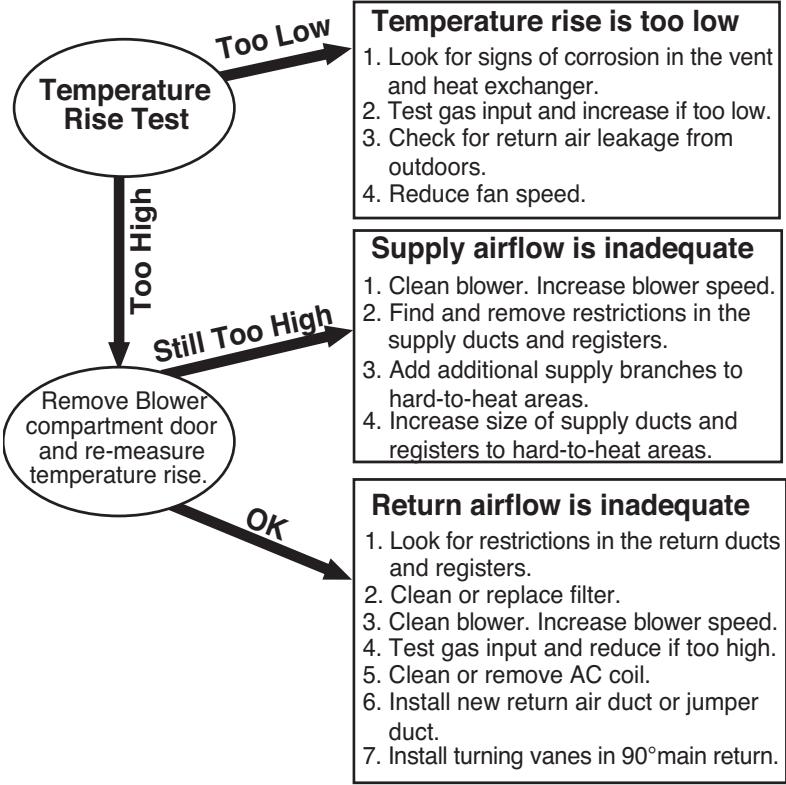



**Table 8-15: Recommended Cross-Sectional Area of Metal Supply and Return Plenums at the Air Handler**

Gas Furnaces		Heat Pumps & Air Conditioners		
BTUH Input	In <sup>2</sup> Area (Supp. & Ret.)	BTUH Capacity	In <sup>2</sup> Area (Supp. & Ret.)	Tons (capacity)
40,000	80	24,000	144	2
60,000	120	30,000	180	2.5
80,000	160	36,000	216	3
100,000	200	42,000	252	3.5
120,000	240	48,000	288	4
140,000	280	54,000	324	4.5
160,000	320	60,000	360	5

Each trunk, supply and return, should have the recommended cross-sectional area shown here. Courtesy: Bruce Manclark

### 8.14.7 Improving Forced-Air System Airflow

#### *SWS Detail: 5.0104.1 New Duct Components*

Inadequate airflow is a common cause of comfort complaints. When the air handler is on there should be a strong flow of air out of each supply register. Low register airflow may mean that a branch duct is blocked or separated, or that return air from the room to the air handler isn't sufficient. When low airflow is a problem, consider specifying the following improvements as appropriate from your inspection.

- ✓ Clean or change filter. Select a less restrictive filter if you need to reduce static pressure substantially.
- ✓ Clean air handler's blower.
- ✓ Clean the air-conditioning coil or heat pump coil. If the blower is dirty, the coil is probably also dirty.

- ✓ On a condensing furnace, clean the secondary heat exchanger coil.
- ✓ Increase blower speed.
- ✓ Verify that balancing dampers to rooms that need more airflow are wide open.
- ✓ Lubricate the blower motor, and check tension on drive belt.

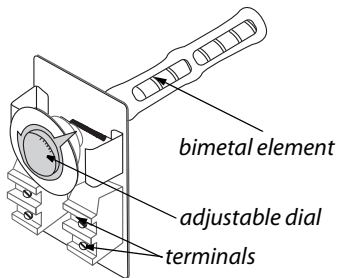

**Fan/limit control:** Turns the furnace blower on and off, according to temperature. Also turns the burner off if the heat exchanger gets too hot.

### Duct Improvements to Increase Airflow

Consider specifying the following duct changes to increase system airflow and reduce the imbalance between supply airflow and return airflow.

- ✓ Modify the filter installation to allow easier filter changing, if filter changing is currently difficult.
- ✓ Install a slanted filter bracket assembly or an enlarged filter fitting to accommodate a larger filter with more surface area and less static-pressure drop compared to the existing filter.

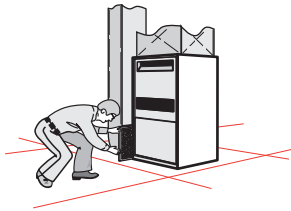

Panel filter installed in filter slot in return plenum

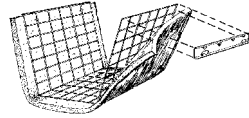

Washable filter installed on a rack inside the blower compartment.

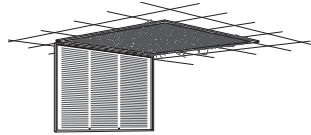

Panel filter installed in return register

**Air-handler filter location:** Filters are installed on the return-air side of forced air systems. Look for them in one or more of the above locations.

- ✓ Remove obstructions to registers and ducts such as rugs, furniture, and objects placed inside ducts (children's toys and water pans for humidification, for example).
- ✓ Remove kinks from flex duct, and replace collapsed flex duct and fiberglass duct board.
- ✓ Remove excessive lengths of slacking flex duct, and stretch the duct to enhance airflow.
- ✓ Perform a Manual D sizing evaluation to evaluate whether to replace branch ducts that are too small.
- ✓ Install additional supply ducts and return ducts as needed to provide heated air throughout the building, especially in additions to the building.
- ✓ Undercut bedroom doors, especially in homes without return registers in bedrooms.
- ✓ Repair or replace bent, damaged, or restricted registers. Install low-resistance registers and grilles.

## 8.14.8 Air Filtration for Air Handlers

Manufacturers equip air handlers with air filters at the factory or recommend that installers install air filters in return ductwork. The purpose of these filters is to protect the blower and heat exchangers from fouling by dust.

Another possible function for air filters is to remove particles from indoor air. This function is useful when the outdoor environment contains a lot of particles, such in large cities, rural areas where wind and agriculture create particulates, or during forest fires.

### Air Filter Effectiveness

The most common filter-rating method is the Minimum Efficiency Rating Value (MERV). A higher MERV rating means that the filter removes more particles and a larger fraction of smaller particles.

The MERV rating system divides particles into three size categories: 0.3–1, 1–3, and 3–10 microns. The two smallest categories are the most important for human health, as small respirable particles (PM<sub>2.5</sub>) can more easily deposit in the lungs compared to larger particles.

The need for high MERV filters depends on the severity of the particle problem in a building. Particles less than 2.5 microns are the most dangerous because they can lodge themselves deep in the lungs. Filtering air with a long-running central air handler or a portable air cleaner can be energy intensive and it may or may not be effective.

The MERV ratings of available HVAC filters range from MERV 3 to MERV 16, with higher ratings removing more particles at smaller sizes. A MERV 3 filter captures large particles — clothing fibers, pollen, and dust mites, but few smaller respirable particles. A MERV16 filter captures more than 95% of all three particle sizes, including bacteria and tobacco smoke. The minimum MERV rating to remove 50% of the respirable 1–3

microns particle-size range is MERV 10. *See also "Air Filtration for Indoor Air Quality" on page 434.*

### Air Filter Pressure and Airflow Effects

Air filters affect the airflow and energy consumption of forced air HVAC systems and balanced ventilation systems. Before choosing the type of air filter, consider its MERV rating and a home's need for particle removal.

HVAC designers designed air handlers for use with low-MERV filters with a small pressure drop. Changing to higher-MERV filters can cause the filter pressure drop to increase and the system airflow to decrease.

Insufficient airflow may cause blowers to fail prematurely as they struggle to overcome system pressures beyond their design specification. For heating systems, the furnaces may overheat and cycle on their high limit switches. Airflow reductions in cooling systems risk coil icing and premature compressor failure. *See also "Air Filtration for Indoor Air Quality" on page 434.*

To reduce the resistance of an high-MERV air filter, consider installing steps to accommodate a larger filter with more surface area and less static-pressure drop compared to the existing filter.

- A slanted filter bracket assembly
- An enlarged filter fitting to allow a filter with more surface area
- Filters in each return register instead of only one at the air handler.

## 8.15 EVALUATING DUCT AIR LEAKAGE

*SWS Detail: 5.0104 Duct Installation; 5.0105 Duct Repair; 5.0106 Duct Sealing*

Duct leakage is a major energy-waster in homes where the ducts are located outside the home's thermal boundary in a crawl

space, attic, attached garage, or leaky unconditioned basement. When these intermediate zones remain outside the thermal boundary, duct sealing is usually cost-effective.

Duct leakage within the thermal boundary isn't usually a significant energy problem.

*See "NFPA Codes" on page 268.*

### 8.15.1 Troubleshooting Duct Leakage

There are several simple procedures for finding the locations of the duct leaks and evaluating their severity.

#### Finding Duct Leaks Using Touch and Sight

One of the simplest ways of finding duct leaks is feeling with your hand for air leaking out of supply ducts, while the ducts are pressurized by the air handler's blower. Duct leaks can also be located using light. Use one of these 4 tests to locate air leaks.

**Finding duct air leaks:** Finding the exact location of duct leaks precedes duct air sealing.

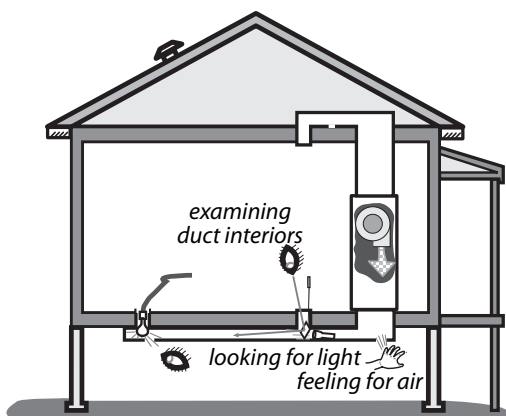

1. Use the air handler blower to pressurize supply ducts. Closing the dampers on supply registers temporarily or partially blocking the register with pieces of carpet, magazines, or any object that won't be blown off by the register's airflow increases the duct pressure and make duct leaks easier to find. Dampening your hand makes

your hand more sensitive to airflow, helping you to find duct air leaks.

2. Place a trouble light, with a 100-watt bulb, inside the duct through a register. Look for light emanating from the exterior of duct joints and seams.
3. Determine which duct joints were difficult to fasten and seal during installation. These joints are likely duct-leakage locations.
4. Use a trouble light, flashlight, and mirror or a digital camera to help you to visually examine duct interiors.

Feeling air leaks establishes their exact location. Ducts must be pressurized in order to feel leaks. You can feel air leaking out of pressurized ducts, but you can't feel air leaking into depressurized return ducts. Pressurizing the home with a blower door forces air through duct leaks, located in intermediate zones, where you can feel the leakage coming out of both supply and return ducts.



**Video: Pressure pan test**— How to use a pressure pan test to gauge the location and relative severity of duct leakage.

## Pressure Pan Testing

Pressure pan tests can identify leaky or disconnected ducts located in intermediate zones. With the house depressurized by the blower door to either  $-25$  pascals or  $-50$  pascals, make pressure pan readings at each supply and return register.

**A pressure pan:** Blocks a single register and measures the air pressure behind it, during a blower-door test. The magnitude of that pressure is an indicator of duct leakage.

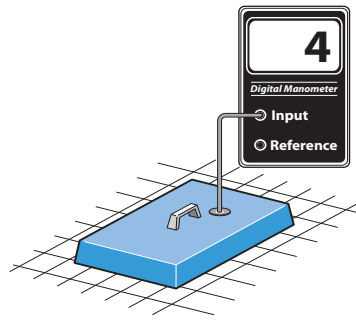

If the ducts are in a basement and the basement is conditioned, pressure pan testing isn't necessary, although air sealing the return ducts for safety is still important.

If instead, the basement is unconditioned, close any openings between the basement and conditioned space. Measure and record the zone pressure of the basement with reference to the conditioned space before pressure pan testing.

1. Install blower door, and set-up house for winter conditions. Open all interior doors.
2. If the basement is conditioned living space, open the door between the basement and upstairs living spaces.
3. If the basement isn't conditioned living space, close the door between basement and upstairs. Then measure and record the zone pressure of the basement with reference to the conditioned space.
4. Turn furnace off at the thermostat or main switch. Remove furnace filter, and temporarily tape filter slot if one exists. Be sure that all grilles, registers, and dampers are fully open.
5. Temporarily seal any outside fresh-air intakes to the duct system.
6. Seal supply registers in unoccupied zones that aren't intended to be heated — an unconditioned basement or crawl space, for example.



7. Open attics, crawl spaces, and garages as much as possible to the outdoors so they don't create a secondary air barrier.
8. Connect hose between pressure pan and the input tap on the digital manometer. Leave the reference tap open.
9. With the blower door's manometer reading  $-25$  or  $-50$  pascals, place the pressure pan completely over each grille or register one by one to form a tight seal. Leave all other grilles and registers open when making a test. Record each reading, which should give a positive pressure.
10. If a grille is too large or a supply register is difficult to cover with the pressure pan (under a kitchen cabinet, for example), seal the grille or register with masking tape. Insert a pressure probe through the masking tape and record the reading. Remove the tape after the test.
11. Use either the pressure pan or tape to test each register and grille in a systematic way.

### Pressure Pan Duct Standards

If the ducts are perfectly sealed with no leakage to the outdoors, you won't measure any pressure difference ( $0.0$  pascals) during a pressure-pan test. The higher the measured pressure reading, the more connected the duct is to the outdoors.

- If the median pressure pan reading is  $4$  pascals or more and/or if one reading is more than  $8$  pascals, duct-sealing is usually cost-effective.
- Following duct-sealing work, no more than three registers should have pressure-pan readings greater than  $2$  pascals. No single reading should be greater than  $4$  pascals.
- The reduction you achieve depends on your ability to find the leaks and whether you can access the leaky ducts. The best weatherization agencies use  $1$  pascal or less as a general goal for all registers.

Examine the registers connected to ducts that are located in areas outside the conditioned living space. Unconditioned spaces containing ducts include attics, crawl spaces, garages, and unoccupied basements. Also evaluate registers attached to stud cavities or panned joists used as return ducts. Leaky ducts, located outside the conditioned living space, may lead to pressure-pan measurements more than 30 pascals if these ducts have large holes.

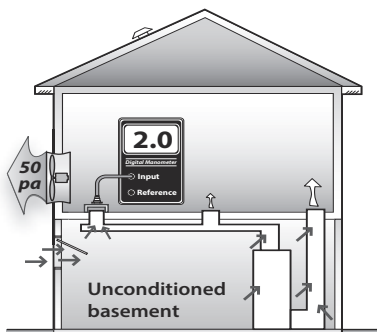

**Pressure pan test:** A pressure pan reading of 2 indicates moderate duct air leakage in the supply ducts.

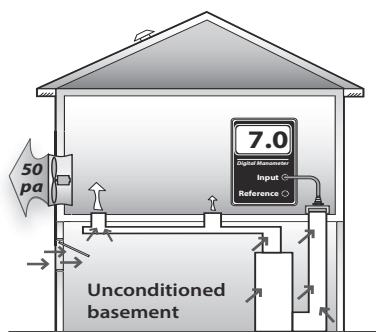

**Problem return register:** A pressure reading of 7 pascals indicates major air leakage near the tested register.

## 8.15.2 Measuring Duct Air Leakage with a Duct Blower

Pressurizing the ducts with a duct blower measures total duct leakage. The duct blower is the most accurate common measuring device for duct air leakage. It consists of a fan, a digital manometer, and a set of reducer plates for measuring different leakage levels. If you use a blower door with a duct blower, you can measure duct leakage to outdoors.

### Measuring Total Duct Leakage

The total duct leakage test measures leakage to both indoors and outdoors. The house and intermediate zones should be open to

the outdoors by way of windows, doors, or vents. Opening the intermediate zones to outdoors insures that the duct blower is measuring only the ducts' airtightness — not the airtightness of ducts combined with other air barriers like roofs, foundation walls, or garages.

Supply and return ducts can be tested separately, either before the air handler is installed in a new home or when an air handler is removed during replacement.

Follow these steps when performing a duct airtightness test.

1. Install the duct blower in the air handler or to a large return register, either using its connector duct or simply attaching the duct blower itself to the air handler or return register with cardboard and tape.
2. Remove the air filter(s) from the duct system.
3. Seal all supply and return registers with masking tape or other non-destructive sealant.
4. Open the house, basement or crawl space, containing ducts, to outdoors.
5. Drill a  $1/4$  or  $5/16$ -inch hole into a supply duct a short distance away from the air handler and insert a manometer hose. Connect a manometer to this hose to measure *duct with reference to (WRT) outdoors*. (Indoors, outdoors, and intermediate zones should ideally be opened to each other in this test).
6. Connect an airflow manometer to measure *fan WRT the area near the fan*.

Check manometer(s) for proper settings. Digital manometers require your choosing the correct mode, range, and fan-type settings.

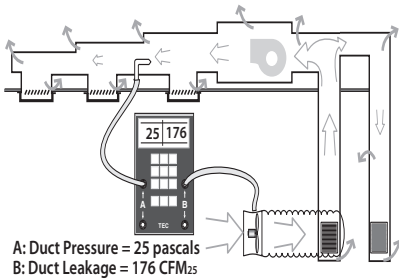

**Total duct air leakage measured by the duct blower:** All registers are sealed except the one connecting the duct blower to the system. Pressurize the ducts to 25 pascals and measure airflow.

1. Turn on the duct blower and pressurize the ducts to 25 pascals.
2. Record duct-blower airflow.
3. While the ducts are pressurized, start at the air handler and move outward feeling for leaks in the air handler, main ducts, and branches.
4. After testing and associated air-sealing are complete, restore filter(s), remove seals from registers, and check air handler.



**Video: Connecting duct tester to air handler**— How to install a duct tester on an example air handler.

## Measuring Duct Leakage to Outdoors

Measuring duct leakage to outdoors gives you a duct-air-leakage value that is directly related to energy waste and the potential for energy savings.

1. Set up the home in its typical heating and cooling mode with windows and outside doors closed. Open all indoor conditioned areas to one another.
2. Install a blower door, configured to pressurize the home.

3. Connect the duct blower to the air handler or to a main return duct.
4. Pressurize the ducts to +25 pascals by increasing the duct blower's speed until this value is reached.
5. Pressurize the house until the pressure difference between the house and duct is 0 pascals (*house WRT ducts*). See "*Blower-Door Test Procedures*" on page 546.
6. Read the airflow through the duct blower. This value is duct leakage to outdoors.

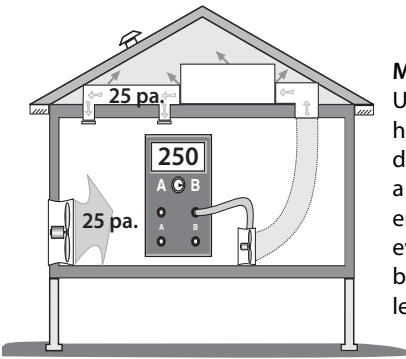

**Measuring duct leakage to outdoors:**

Using a blower door to pressurize the house with a duct blower to pressurize the ducts measures leakage to the outdoors — a smaller number and a better predictor of energy savings. This test is preferred for evaluating duct leakage for specialists in both building air leakage and duct air leakage.



**Video: Duct pressurization test setup**

— How to pressurize duct to test air leakage.

### 8.15.3 Measuring House Pressure Caused by Duct Leakage

The following test measures pressure differences between the house and outdoors, caused by duct leakage. Try to correct pressure differences greater than +2.0 pascals or more negative than -2.0 pascals because of the air leakage that the pressure differences create.

1. Close all windows and exterior doors. Turn-off all exhaust fans.
2. Open all interior doors, including door to basement.
3. Measure the baseline house-to-outdoors pressure difference and zero it out using the baseline procedures described in *“Blower-Door Test Procedures”* on page 546.
4. Turn on air handler.
5. Measure the house-to-outdoors pressure difference. This test indicates dominant duct leakage as shown here.

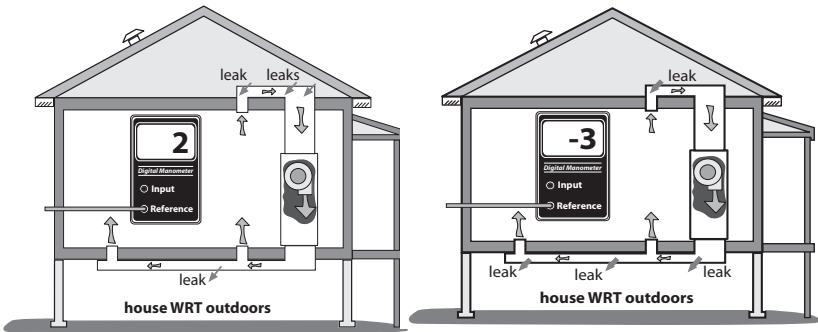

**Dominant return leaks:** When return leaks are larger than supply leaks, the house shows a positive pressure with reference to the outdoors.

**Dominant supply leaks:** When supply leaks are larger than return leaks, the house shows a negative pressure with reference to the outdoors.

A positive pressure indicates that the return ducts (which pull air from leaky intermediate zones) are leakier than the supply ducts. A negative pressure indicates that the supply ducts (which push air into intermediate zones through their leaks) are leakier than return ducts. A pressure at or near zero indicates equal supply and return leakage or else little duct leakage.

## 8.16 SEALING DUCT LEAKS

*SWS Detail: 5.0106 Duct Sealing; 5.0106.1 General Duct Sealing; 5.0106.2 Duct Sealing - Spray Polyurethane Foam (SPF); 5.0105 Duct Repair*

Ducts located outside the thermal boundary or in an intermediate zone like a ventilated attic or crawl space should be sealed. The following is a list of duct leak locations in order of their relative importance. Leaks nearer to the air handler are exposed to higher pressure and are more important than leaks further away.

*See “NFPA Codes” on page 268.*

### 8.16.1 Duct Repair and Sealing Methods

*SWS Detail: 5.0105 Duct Repair; 5.0106 Duct Sealing; 5.0106.1 General Duct Sealing; 5.0106.2 Duct Sealing - Spray Polyurethane Foam (SPF)*

#### Duct Repair and Fastening

Before you air seal ducts, make necessary repairs using these general guidelines.

- ✓ Attach flex duct to metal duct or duct board with a rigid metal coupling, using two tensioned tie bands per joint.
- ✓ Fasten round ducts to round ducts or fittings with a minimum of three equally spaced galvanized or stainless steel fasteners.
- ✓ Fasten duct board to duct board, using overlapping joints, UL 181 fiber mesh tape or aluminum tape, mastic, stitch staples, or other approved products.
- ✓ Fasten duct boots to wood using a minimum of 1 stainless steel or galvanized fastener per side.
- ✓ Fasten duct boots to drywall with mesh tape or a duct-boot hanger, if the boot is accessible.

- ✓ Support flexible and duct board ducts and plenums with 1- $\frac{1}{2}$ -inch wide or greater material, installed every 4 feet or less. Don't pinch the duct or reduce its interior dimensions.
- ✓ Support metal ducts with  $\frac{1}{2}$ -inch-wide or greater eighteen-gauge metal straps, 12-gauge galvanized wire, or metal rods every 10 feet or less.

## General Duct-Sealing Methods

Duct sealers install duct mastic and fiberglass mesh to seal duct leaks. When they need reinforcement or temporary closure, the duct sealers use tape or sheet metal. Observe these standards.

- ✓ Remove any substance that would prevent sealant adhesion (tape, oil, dirt) using appropriate methods and solvents.
- ✓ Seal seams, cracks, joints, and holes, less than  $\frac{1}{4}$  inch using mastic and fiberglass mesh.
- ✓ Bridge seams, cracks, joints, holes, and penetrations, between  $\frac{1}{4}$  and  $\frac{3}{4}$  inch, with sheet metal or tape. Then cover the metal or tape completely with mastic reinforced by mesh at seams.
- ✓ Repair leaks larger than  $\frac{3}{4}$  inch using a rigid duct patch. Mechanically fasten patch before applying mastic. Install mesh and mastic over seams, overlapping repair joint by at least one inch on all sides
- ✓ Overlap the mastic and mesh at least one inch beyond the seams, repairs, and reinforced areas of the ducts.

### 8.16.2 Sealing Return Ducts

*SWS Detail: 5.0106 Duct Sealing; 5.0106.1 General Duct Sealing; 5.0106.2 Duct Sealing - Spray Polyurethane Foam (SPF)*



Return leaks are important for combustion safety and for efficiency. Use the following techniques to seal return ducts.

- ✓ First, seal all return leaks within the combustion zone to prevent this leakage from depressurizing the combustion zone and causing backdrafting.
- ✓ Seal all return ducts in basements and crawl spaces for indoor air quality.
- ✓ Seal filter slots with a tight-fitting, durable, user-friendly filter-slot cover to allow easy removal for filter-changing.
- ✓ Seal the joint between the furnace and return plenum with a removable sealant such as foil tape.

### Panned or Cavity Return Ducts

- ✓ Seal panned return ducts using mastic to seal all cracks and gaps within the return duct and register.
- ✓ Seal leaky joints between building materials composing cavity return ducts, like panned floor cavities and furnace return platforms. Remove the panning to seal cavities containing joints in building materials.
- ✓ Carefully examine and seal leaks at transitions between panned floor joists and metal trunks that change the direction of the return ducts. You may need a mirror to find some of the biggest return duct leaks in these areas.

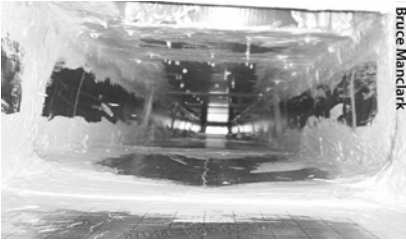

**Lining a panned cavity:** Foil-faced foam board, designed for lining cavities is sealed with duct mastic to provide an airtight return.

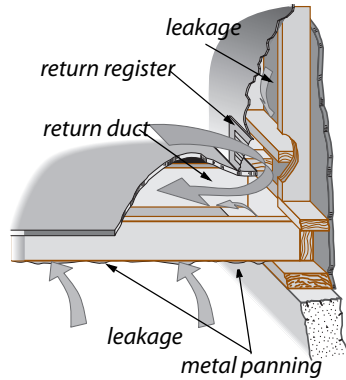

**Panned floor joists:** These return ducts are often very leaky and may require removing the panning to seal the cavity.



**Pedestal return air:** These return plenums are often very leaky and may require removing a panel to seal the leaks from inside.

### 8.16.3 Sealing Supply Ducts

*SWS Detail: 5.0106 Duct Sealing; 5.0106.1 General Duct Sealing; 5.0106.2 Duct Sealing - Spray Polyurethane Foam (SPF)*

Inspect these places in the duct system and seal them as needed.

- ✓ *Plenum joint at air handler:* Technicians might have had problems sealing these joints because of a lack of space. Seal these plenum connections thoroughly even if you must cut an access hole in the plenum. Use silicone caulking or foil tape instead of mastic and fabric mesh here for future access — furnace replacement, for example.

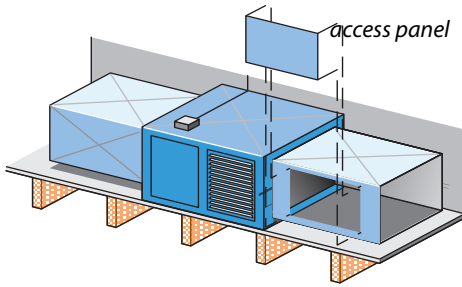

**Plenums, poorly sealed to air handler:** When air handlers are installed in tight spaces, plenums may be poorly fastened and sealed. Cutting a hole in the duct may be the only way to seal this important joint.



**Sectioned elbows:** Joints in sectioned elbows, known as gores, are usually leaky and require sealing with duct mastic.

- ✓ *Joints at branch takeoffs:* Seal these important joints with a thick layer of mastic. Fabric mesh tape should cover gaps and reinforce the seal at gaps.
- ✓ *Joints in sectioned elbows:* Known as gores, these are usually leaky and require sealing with duct mastic.
- ✓ *Tabbed sleeves:* Attach the sleeve to the main duct with 3-to-5 screws and apply mastic plentifully. Or better, remove the tabbed sleeve and replace it with a manufactured take-off.
- ✓ *Flexduct-to-metal joints:* Apply a 2-inch band of mastic to the end of the metal connector. Attach the flexduct's inner liner with a UL-181-approved tie band, tightening it with a tie-band tensioner. Attach the insulation and outer liner with another tie band.
- ✓ *Damaged flex duct:* Replace flex duct when it is punctured, deteriorated, or otherwise damaged.
- ✓ *Deteriorating ductboard facing:* Replace ductboard, preferably with metal ducting, when the facing deteriorates because this deterioration leads to a lot of air leakage.

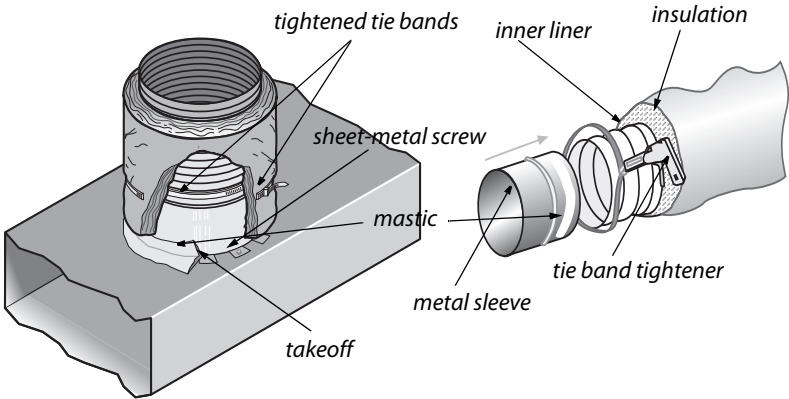

**Flexduct joints:** Flexduct itself is usually fairly airtight, but joints, sealed improperly with tape, can be very leaky. Use methods shown here to make flexduct joints airtight.

- ✓ Consider closing supply and return registers in unoccupied basements or crawl spaces.
- ✓ Seal penetrations made by wires or pipes traveling through ducts.
- ✓ Seal the joint between the boot and the ceiling, wall, or floor between conditioned and unconditioned areas.

## Duct Support

- ✓ Support rigid ducts and duct joints with duct hangers at least every 5 feet or as necessary to prevent sagging of more than one-half inch.
- ✓ Support flexible ducts and duct board every 4 feet using a minimum of 1 ½" wide support material.



**Sealing register boots:** Seal between the boot and floor. Seal joints inside the boot.

## 8.16.4 Materials for Duct Sealing

Duct mastic is the best duct-sealing material because of its superior durability and adhesion. Apply mastic at least  $\frac{1}{16}$ -inch thick, and use reinforcing mesh for all joints wider than  $\frac{1}{8}$ -inch or joints that may move. Install screws to prevent joint movement or separation.

Aluminum foil or cloth duct tape aren't good materials for duct sealing because their adhesive often fails. Consider covering tape with mastic to prevent tape's adhesive from drying out and failing.

## 8.17 DUCT INSULATION

*SWS Detail: 5.0107 Duct Insulation; 5.0107.1 General Duct Insulation*

Insulate supply ducts, located in unconditioned areas outside the thermal boundary, such as crawl spaces, attics, and attached garages. Use vinyl- or foil-faced duct insulation. Don't insulate ducts that run through conditioned areas unless they cause overheating in winter or condensation in summer. Use these best practices for installing insulation.

- ✓ Always perform necessary duct sealing before insulating ducts.

- ✓ Duct-insulation R-value must be  $\geq R-8$  indoors and  $\geq R-12$  outdoors.
- ✓ Select insulation with a flame spread and smoke developed index listed at 25/50.
- ✓ Insulation should cover all exposed supply ducts, with no significant areas of bare duct left uninsulated.

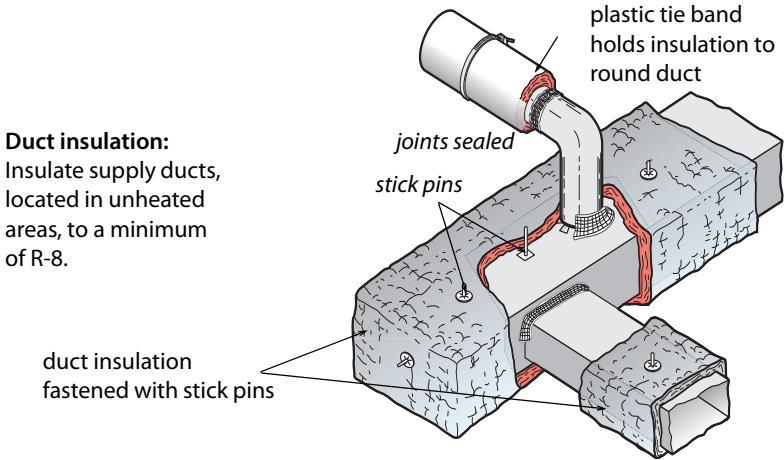

- ✓ Insulation's compressed thickness must be more than 75% of its uncompressed thickness. Don't compress duct insulation excessively at corner bends.
- ✓ Fasten insulation using mechanical means such as stick pins, twine, staples, or plastic tie bands.
- ✓ Cover the insulation's joints with UL 181 tape to seal all gaps.
- ✓ Install the duct insulation 3 inches away from heat-producing devices such as recessed light fixtures.
- ✓ Post a dated receipt, signed by the installer, that includes: Installed insulation type, coverage area, installed thickness, and installed R-value.

**Caution:** Burying ducts in attic insulation is common in some regions and it reduces energy losses from ducts. However, condensation on ducts in humid climates is common during the air-

conditioning season, so don't allow cellulose to touch metal ducts to avoid corrosion from cellulose's Borate fire retardant.

**Important Note:** Tape can be effective for covering joints in the insulation to prevent air convection, but the tape fails when expected to resist the force of the insulation's compression or weight. Outward-clinch staples or plastic tie bands can help hold the insulation facing and tape together.

## 8.18 HOT-WATER SPACE-HEATING DISTRIBUTION

*SWS Detail: 5.0201 Controls; 5.0202 Distribution; 5.0203 Equipment Installation; 5.0204 Clean and Tune; 5.0288 Special Considerations*

The most significant energy wasters in hot-water systems are poor steady-state efficiency, off-cycle flue losses stealing heat from the stored water, and boilers operating at a too-high water temperature. For information about boiler installation, *see page 301*.

*See "NFPA Codes" on page 268.*

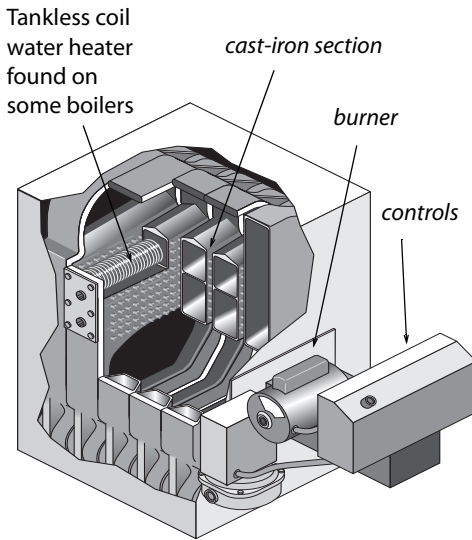

**Cast-iron sectional boilers:**  
The most common boiler type for residential applications.

## 8.18.1 Boiler Efficiency and Maintenance

*SWS Details: 5.0288.1 Boiler Room Water Drainage; 5.0204.1 Fuel-Fired Boilers*

Monitor boiler performance and efficiency in the following ways.

- Corrosion, scaling, and dirt on the water side of the heat exchanger.
- Corrosion, dust, and dirt on the fire side of the heat exchanger.
- Excess air during combustion from air leaks and incorrect fuel-air mixture.
- Off-cycle air circulation through the firebox and heat exchanger, removing heat from stored water.



## Boiler Efficiency Improvements

Consider the following maintenance and efficiency improvements for both hot-water and steam boilers based on boiler inspection.

- ✓ Check for leaks on the boiler, around its fittings, or on any of the distribution piping connected to the boiler.
- ✓ Clean fire side of heat exchanger of noticeable dirt.
- ✓ Drain water from the boiler drain until the water flows clean. Verify that the fill valve replaces the water you drained.

### 8.18.2 Distribution System Improvements

*SWS Details: 5.0204.1 Fuel-Fired Boilers; 5.0202 Distribution; 5.0202.1 Radiator Reflector; 5.0202.2 Distribution Insulation*

Hydronic distribution systems consist of the supply and return piping, the circulator, expansion tank, air separator, air vents, and heat emitters. A properly designed and installed hydronic distribution system can operate for decades without service. However, many systems have installation flaws or need service.

**Note:** You can recognize a hot-water boiler by its expansion tank, located somewhere above the boiler. The expansion tank provides an air cushion to allow the system's water to expand and contract as it is heated and cooled. Without a functioning expansion tank excessive pressure in the boiler discharges water through the pressure-relief valve.

#### Safety Checks and Improvements

Work with contractors and technicians to specify and verify the following safety and efficiency tests and inspections.

- ✓ Verify the existence of a 30-psi-rated pressure relief valve. The pressure relief valve should have a drain pipe that terminates 6 inches from the floor. Replace a malfunctioning

valve, or install a pressure relief valve if none exists. Look for signs of leakage or discharges. Find out why the pressure relief valve is discharging.

- ✓ Verify that the expansion tank isn't waterlogged or isn't too small for the system. A waterlogged expansion tank can make the pressure relief valve discharge. Measure the expansion tank's air pressure. A common pressure for one and two-story buildings is 12 psi. The pressure in taller buildings should be approximately one (1) psi per 2.3 feet of the distribution system's height.
- ✓ If you observe rust in venting, verify that the return water temperature is warmer than 130°F for gas and warmer than 140°F for oil. These minimum water temperatures prevent acidic condensation.
- ✓ Verify that high-limit control extinguishes the burner at a water temperature of 200°F or less.
- ✓ Lubricate circulator pump(s) if necessary.

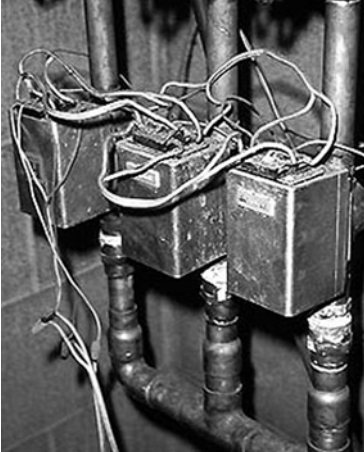

**Zone valves:** Separate thermostats control each zone valve. Zone valves have switches that activate the burner.

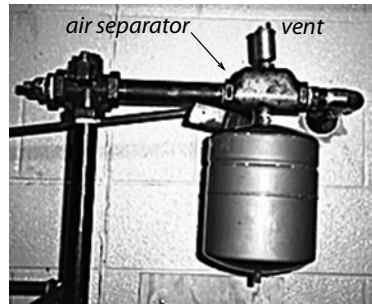

**Expansion tank, air separator, and Vent:** Preventing excessive pressure and eliminating air from the systems are important for hydronic distribution systems.

## Simple Efficiency Improvements

Do the following energy-efficiency improvements.

- ✓ Repair water leaks in the system.
- ✓ Remove corrosion, dust, and dirt on the fire side of the heat exchanger.
- ✓ Check for excess air during combustion from air leaks and incorrect fuel-air mixture.
- ✓ Bleed air from radiators and piping through air vents on piping or radiators. Most systems fill automatically through a shutoff and pressure-reducing valve connected to the building's water supply.
- ✓ If there is a shutoff but no pressure-reducing valve, install one. Set the pressure-reducing valve to the hydronic-system pressure. Then check the system pressure at the expansion tank, and adjust the pressure as necessary.

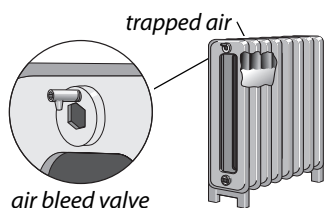

**Purging air:** Trapped air collects at the hot-water system's highest parts. Bleeding air from radiators fills the radiator and gives it more heating surface area.

- ✓ Vacuum and clean fins of fin-tube convectors if you notice dust and dirt there.
- ✓ Insulate all supply and return piping, passing through unheated areas, with pipe insulation, at least R-3, rated for temperatures up to 200° F and compliant with fire safety codes. Secure seams with a durable sealant or zip ties.
- ✓ Install radiator reflector (insulated or uninsulated) behind radiators. Maintain a continuous air space between the reflector and the radiator. Meet applicable fire code requirements.

## Improvements to Boiler Controls

Consider these improvements to control systems for hot-water boilers.

- ✓ Install outdoor reset controllers to regulate water temperature, depending on outdoor temperature.
- ✓ If possible, operate the boiler without a low-limit control for maintaining a minimum boiler-water temperature. If the boiler heats domestic water in addition to space heating, the low-limit control may be necessary.
- ✓ After control improvements like two-stage thermostats or reset controllers, verify that return water temperature is high enough to prevent condensation and corrosion in the chimney as noted previously.
- ✓ Install electric vent dampers on natural-draft gas- and oil-fired high-mass boilers.

## 8.19 STEAM HEATING AND DISTRIBUTION

*SWS Details: 5.0203 Equipment Installation; 5.0202 Distribution; 5.0202.1 Radiator Reflector; 5.0202.2 Distribution Insulation; 5.0201 Controls; 5.0201.1 Thermostat Replacement; 5.0204.1 Fuel-Fired Boilers; 5.8801 Equipment Removal*

Steam heating is less efficient than hot-water heating because steam requires higher temperatures than hot water. For single-family homes, consider replacing a steam heating system with a hot-water or forced-air system. Multifamily buildings, especially multi-story buildings, may have little choice but to continue with steam because of the high cost of switching systems.

Operate steam systems at the lowest steam pressure that heats the building adequately. Two psi on the boiler-pressure gauge is a practical limit for many systems although some systems can operate at pressures down to a few ounces per square inch of

pressure. Traps and air vents are crucial to operating at a low steam pressure.

Post on the equipment or in a conspicuous location, a list of all systems and components inspected, results, and services performed. Include service personnel name, contact information, and date of service.

**Note:** You can recognize a steam boiler by its sight glass, which indicates the boiler's water level. Notice that the water doesn't completely fill the boiler, but instead allows a space for the steam to form above the boiler's water level.

*See "NFPA Codes" on page 268.*



**Sight glass & low-water control:** The sight glass shows the boiler water level. The low water control adds water to the boiler and extinguishes the burner if the water level is too low.

## 8.19.1 Steam System Maintenance

*SWS Details: 5.0204.1 Fuel-Fired Boilers; 5.0288.1 Boiler Room Water Drainage*

Do these safety and maintenance tasks on steam systems.

- ✓ Verify that steam boilers have functioning high-pressure limits and low-water cut-off controls.
- ✓ Verify that flush valves on low-water cutoffs flush water but don't leak water.
- ✓ Verify the function of the low-water cutoff by flushing the low-water cutoff with the burner operating. Combustion should stop when the water level in the boiler drops below the level of the float. If combustion continues, repair or replace the low-water cutoff.
- ✓ Consider flushing the boiler if you find dirt in the water from flushing the low-water cutoff.
- ✓ Clean heat exchangers and burners if you see significant dirt deposits.
- ✓ Suggest that the building manager begin a schedule of boiler blow-down, chemical analysis, and chemical treatment.
- ✓ Inspect: automatic fill valves, zone valves, condensate tanks, and air vents.
- ✓ Specify that technicians drain mud legs on return piping.

## 8.19.2 Steam System Energy Conservation

*SWS Details: 5.0204.1 Fuel-Fired Boilers; 5.0288.1 Boiler Room Water Drainage*

Specify the following efficiency checks and improvements for steam systems.

### General Steam System Improvements

- ✓ Repair leaks on the steam supply piping or on condensate return piping.

- ✓ Consider a flame-retention burner and electric vent damper as retrofits for steam boilers.
- ✓ Insulate steam pipes with pipe insulation designed for steam, R-3 or greater, and compliant with fire safety codes. Secure seams with a durable sealant or zip ties. Post a dated receipt signed by the installer that includes: insulation type, coverage area, installed thickness, and installed R-value.
- ✓ Install radiator reflector (insulated or uninsulated) behind radiators. Maintain a continuous air space between the reflector and the radiator. Meet applicable fire code requirements.

### One-Pipe Steam

- ✓ Verify that high-pressure limit control is set at or below 1 (one) psi or as low as acceptable in providing heat to the far ends of the building.
- ✓ Verify that steam reaches all radiators during every steam cycle. Steam need not fill radiators on every cycle. In mild weather, steam partly fills radiators before the boiler cycles off.
- ✓ Radiator air vents should be open to release air while the system is filling with steam, then closed when steam reaches the vents. Replace malfunctioning radiator air vents as necessary. However, don't over-vent radiators because this can cause water hammer.
- ✓ Verify air vents function and that all steam radiators receive steam during every cycle. Unplug air vents or replace malfunctioning vents as necessary. Add vents to steam lines and radiators as needed to get steam to all the registers.

## Two-Pipe Steam

- ✓ When you can gain access to all the system's steam traps, repair leaking steam traps or replace them. All failed traps should be replaced at the same time to prevent new traps failing because of water hammer from steam leakage through neighboring failed traps. The only 100% reliable way to test a steam trap is to connect it to a test apparatus and see if it allows steam to pass. However if you have an accurate thermometer, the temperature on the radiator side of a functioning trap should be more than 215°F and the temperature on the return side of that trap should be less than 205°F when steam is in the radiator.

**One-pipe and two-pipe steam systems:** Still common in multifamily buildings, one-pipe steam works best when very low pressure steam can drive air out of the piping and radiators quickly through plentiful vents. Vents are located on each radiator and also on main steam lines.

**Two-pipe steam systems:** Radiator traps keep steam inside radiators until it condenses. No steam should be present at the condensate tank.

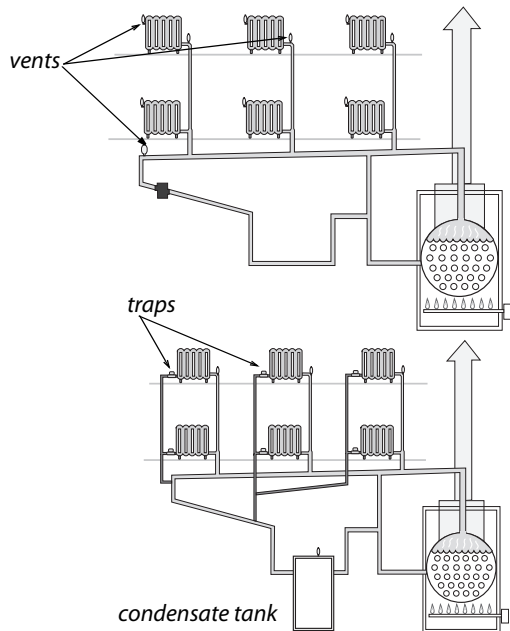

- ✓ When you can't gain access to all the system's steam traps at the same time, consider abandoning failed steam traps and installing radiator-inlet orifices in two-pipe steam radiators. The orifices limit steam flow to an amount that can condense within the radiator. Orifices can also reduce



steam delivery to oversized radiators by 20% or a little more.

- ✓ Consider controlling radiators with thermostatic radiator valves (TRVs) except for radiators in the coolest rooms. TRVs can improve systems than use either traps or orifices. For effective temperature control, the thermostatic element of the TRVs must be located in the path of air moving toward the radiator or convector. TRVs are available with sensors located remotely from the valve, which solves the problem of a valve located where the radiator heats a valve-mounted sensor, fooling it into closing.
- ✓ Inspect return lines and condensate receiver for steam coming back to the boiler. Check radiator and main line traps.
- ✓ Check steam traps with a digital thermometer or listening device to detect any steam escaping from radiators through the condensate return. Replace leaking steam traps or their thermostatic elements.
- ✓ Consider installing remote sensing thermostats that vary cycle length according to outdoor temperature and include night-setback capability.

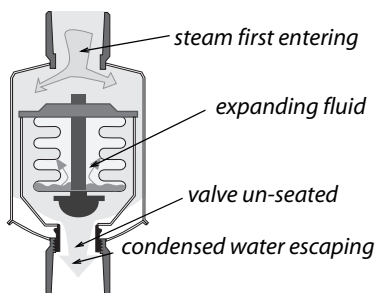

**Steam traps:** Steam enters the steam trap heating its element and expanding the fluid inside. The expanded element plugs the steam's escape with a valve.

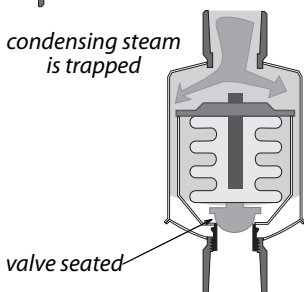

## 8.20 REPLACING THERMOSTATS

*SWS Details: 5.0101.1 Thermostat Replacement; 5.0201.1 Thermostat Replacement*

### Installing Thermostats

- ✓ Verify the number of thermostat wires available to meet the needs of the replacement thermostat.
- ✓ Install thermostat where it accurately reflects the temperature and humidity of the zone which it controls.
- ✓ Don't install a thermostat in a place exposed to extreme temperatures, radiant heat sources, or drafts.
- ✓ Seal penetrations for control wire with a durable sealant.
- ✓ Provide occupants/owners with user's manual, warranty information, installation instructions, and installer contact information.

## Programmable Thermostats

A programmable thermostat may be a big energy saver if the building's occupants understand how to program it. However, a programmable thermostat won't save any energy if occupants already control day and night temperatures effectively.

- ✓ Before you replace the existing thermostat, discuss the operation of programmable thermostats with occupants.
- ✓ If they can use a programmable thermostat effectively, then install one.
- ✓ Educate occupants on setting the programmable thermostat and leave a copy of manufacturer's directions with them.

**Note:** Programmable thermostats may not work effectively with hydronic heating systems because of slow temperature change in those systems.

## Heat Pump Thermostats

- ✓ Select a double-setback programmable thermostat that allows for full functionality of the installed HVAC system, including supplementary heat, emergency heat, fan only, and ventilation control.
- ✓ Connect supplementary heat to second-stage heating terminal in accordance with manufacturer's specifications.
- ✓ Install outdoor temperature sensor, compatible with the thermostat, according to manufacturer's specifications.

**Inside a programmable thermostat:**  
In addition to the instructions on the exterior of this thermostat are instructions inside for setting the heat anticipator.

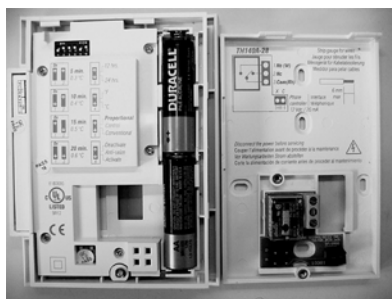

Many models of programmable thermostats have settings that you select from inside the thermostat. These settings include the heat-anticipator setting, which adjusts the cycle length of the heating or cooling system.

## 8.21 ELECTRIC HEAT

*SWS Details: 5.0301 Room Conditioning; 5.0101.1 Thermostat Replacement; 5.8801.1 Decommissioning; 5.0104 Duct Installation; 5.0105 Duct Repair; 5.0106 Duct Sealing*

Electric heaters are usually 100% efficient at converting the electricity to heat in the room where they are located.

*See “NFPA Codes” on page 268.*

### 8.21.1 Electric Baseboard Heat

Electric baseboard heaters are zonal heaters controlled by thermostats within the zone they heat. Electric baseboard heat can help to minimize energy costs, if residents take advantage of the ability to heat by zones.

Baseboard heaters contain electric resistance heating elements encased in metal pipes. These are surrounded by aluminum fins to aid heat transfer. As air within the heater is heated, it rises into the room. This draws cooler air into the bottom of the heater.

- Make sure that the baseboard heater sits at least an inch above the floor to facilitate good air convection.
- Clean fins and remove dust and debris from around and under the baseboard heaters as often as necessary.
- Avoid putting furniture directly against the heaters. To heat properly, there must be space for air convection.

The line-voltage thermostats used with baseboard heaters sometimes don't provide good comfort. This is because these thermo-

stats allow the temperature in the room to vary by 2°F or more. Newer, more accurate thermostats are available. Programmable thermostats for electric baseboard heat use timers or a resident-activated button that raises the temperature for a time and then automatically returns to the setback temperature. Some baseboard heaters use low-voltage thermostats connected to relays that control baseboard heaters in rooms.

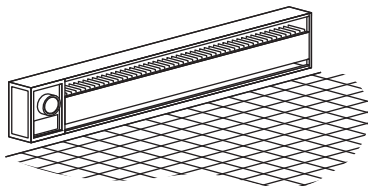

**Electric baseboard:** Electric baseboard is more efficient than an electric furnace and sometimes even outperforms a central heat pump because it is easily zone-able. The energy bill is determined by the habits of the occupants and the energy efficiency of the building.

## 8.21.2 Electric Furnaces

Electric furnaces heat air moved by its fan over several electric-resistance heating elements. Electric furnaces have two to six elements — 3.5 to 7 kW each — that work like the elements in a toaster. The 240-volt thermostat circuit energizes devices called sequencers that bring the 240 volt heating elements on in stages when the thermostat calls for heat. The variable speed fan switches to a higher speed as more elements engage to keep the air temperature stable.

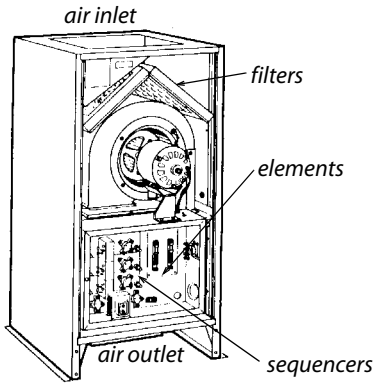

**Electric furnace:** A squirrel-cage blower blows air over 2 to 6 electric resistance coils and down into the plenum below the floor.

## 8.22 HEAT-PUMP ENERGY EFFICIENCY

*SWS Details: 5.0108.1 Air-to-Air Split System; 5.0108.2 Air-to-Air Package Unit; 5.0108.3 Mini-Split System; 5.0109 Clean and Tune; 5.0109.2 Air Handler; 5.0109.1 Condensers; 5.0109.3 Evaporators; 5.0101.1 Thermostat Replacement; 5.8801 Equipment Removal*

An air-source heat pump is almost identical to an air conditioner, except for a reversing valve that allows refrigerant to follow two different paths, one for heating and one for cooling. Heat pumps move heat with refrigeration rather than converting it from the chemical energy of a fuel.

Like air conditioners, air-source heat pumps are available as centralized units with ducts or as room units. Heat pumps are 1.5 to 3 times more efficient than electric furnaces. Heat pumps can provide competitive comfort and value with combustion furnaces, but they must be installed with great care and planning.

**Heat pump:** The air handler contains a blower, indoor coil, strip heat, and often a filter. Static pressure and temperature rise are two indicators of performance.

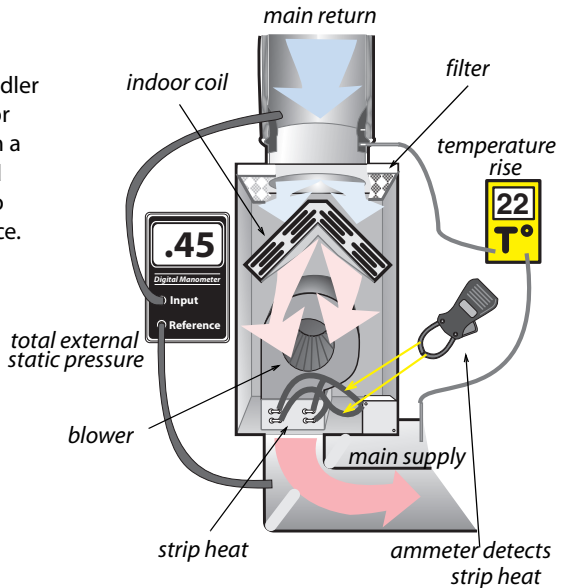

Heat pumps are also equipped with auxiliary electric resistance heat, called strip heat. The energy efficiency of a heat pump depends on how much of the heating load the compressor provides without using the strip heat.

### 8.22.1 Evaluating Heat Pumps During the Heating Season

Heat pumps should have two-stage thermostats designed for use with heat pumps. The first stage is compressor heating and the second stage is the inefficient strip heat. Evaluating heat pumps in the winter is more difficult than a summer evaluation.

Although we can generally evaluate the heat pumps refrigerant charge in the winter, it may be necessary to return in warm weather to more accurately charge the system. This summer verification is required with new heat-pump installations.

Consider these steps to evaluate heat pumps during the winter.

- ✓ Measure the airflow of the air handler by temperature rise method, flow plate or flow hood. Heat pumps must have 400-450 CFM per ton.
- ✓ Look for a temperature rise of 20°F when the outdoor temperature is 32°F. Add or subtract 1° of temperature rise for every 3° it is over or under 32°F outdoor.
- ✓ Check for operation of strip heat by measuring amperage. Then use the chart shown here to find out if strip heat is operating.

**Is strip heat activated?** Using an ammeter and the nameplate data on the heat pump, a technician can know when and if the strip heat is activated.

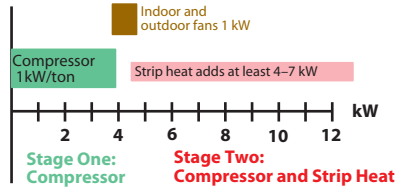

- ✓ External static pressure should be 0.5 IWC (125 pascals) or less for older, fixed-speed blowers and less than 0.8 IWC (200 pascals) for variable-speed blowers. Lower external static pressure promotes higher airflow.
- ✓ Seal supply and return ducts and insulate them after you've verified the airflow as adequate. Measure airflow again after duct sealing.

Most residential central heat pumps are split systems with the indoor coil and air handler indoors and outdoor coil and compressor outdoors. Individual room heat pumps are more efficient because they don't have ducts, and are factory-charged with refrigerant. The illustrations show features of an energy-efficient heat pump installation.

In the summer, use the same procedures to evaluate central heat pumps as to evaluate central air conditioners, described on [page 398](#).



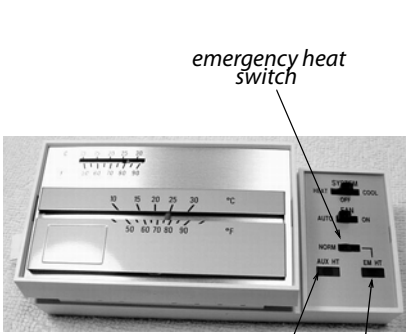

*emergency heat switch*

*auxiliary heat indicator light*

*emergency heat indicator light*

**Heat pump thermostat:** These should have two indicator lights, one for auxiliary heat and one for emergency heat.

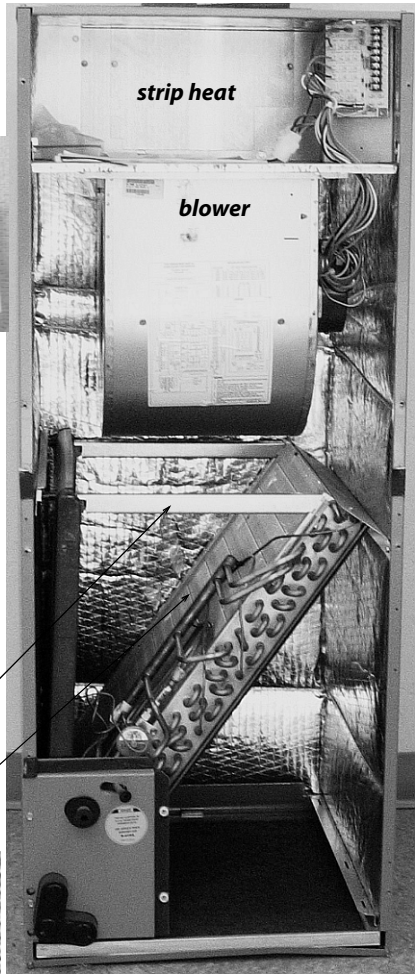

*filter bracket*

*indoor coil*

**Heat pump:** This upflow indoor air handler contains a blower, indoor coil, strip heat, and filter bracket.

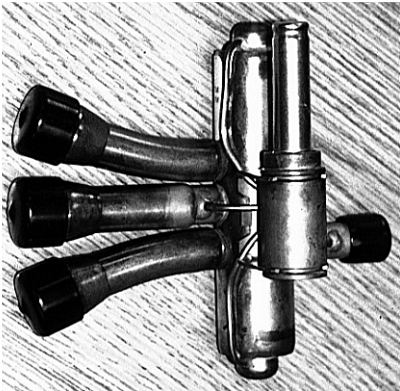

**Reversing valve:** The outdoor unit contains a reversing valve installed near the compressor.

The illustration shows features of an energy-efficient heat pump installation.

Multiple returns ensure good airflow to all parts of the home.

Outdoor thermostat prevents strip heat from operating until outdoor temperature is less than 40°F. Thermostat stages elements as needed.

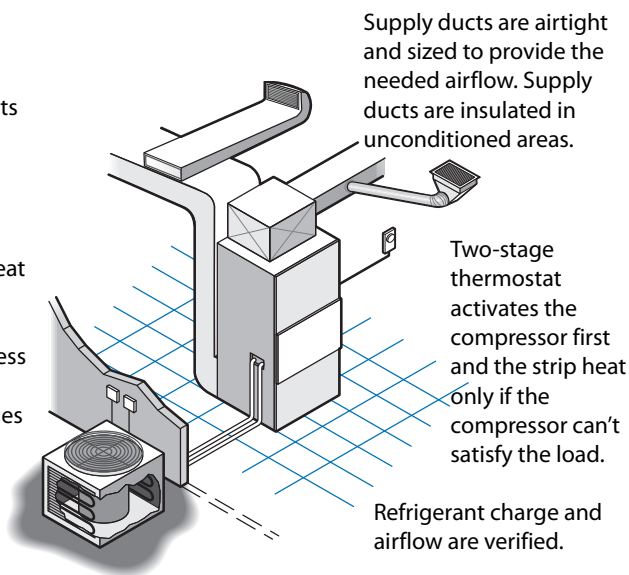

Coil is cleaned every year. Weeds, grass and shrubs shouldn't grow within 3 feet. Verify that no airflow restrictions exist above the outdoor unit.

## 8.22.2 Room or Unitary Heat Pumps

*SWS Details: 5.0301.1 Through-Wall and Window Units; 5.0108.2 Air-to-Air Package Unit; 5.8801 Equipment Removal*

Room heat pumps can provide all or part of the heating and cooling needs for small homes. These one-piece room systems (also known as terminal systems) look like a room air conditioner, but provide both heating and cooling. They can also provide ventilation air when neither heating nor cooling are required. They mount in a window or through a framed opening in a wall.

Room (or unitary) heat pumps can be a good choice for replacing existing unvented gas space heaters. Their fuel costs may be somewhat higher than gas furnaces. However, they are safer than combustion appliances.

Room heat pumps are more efficient than ducted units because they heat a single zone and don't have duct losses. If they replace electric resistance heat, they consume only one-half to one-third the electricity to produce the same amount of heat.

## Selection

Room heat pumps draw a substantial electrical load, and may require 240-volt wiring.

- ✓ Select an ENERGY STAR® qualified model with Energy-Saver Mode or better.
- ✓ Size the new unit according to Manual J, assuming design temperatures of 75 degrees for cooling and 70 degrees for heating.
- ✓ Select a room heat pump, that's input matches available voltage and doesn't exceed the dedicated circuit's ampacity.

## Installation

- ✓ Before installing through-wall unit, seal all adjacent framing and provide a sealed opening.
- ✓ Pipe condensate away from the building or to a sanitary drain.
- ✓ Insulate condensate drain to a minimum of R-3 if the possibility of freezing or condensation exists.
- ✓ Remove old room heat pump or air conditioner from job site and recycle or dispose of it, according to local and federal law.
- ✓ Provide occupants with a user's manual, warranty information, installation instructions, and installer contact information

**Caution:** Don't operate room heat pumps with extension cords or plug adapters.

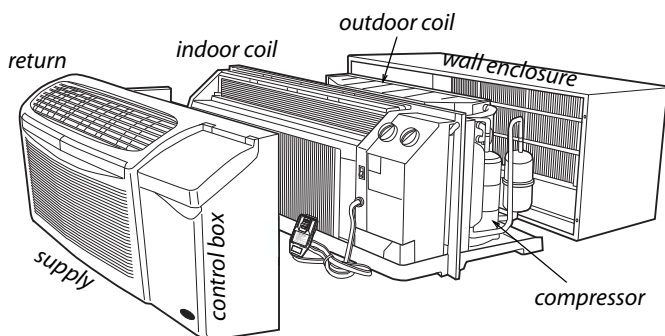

**Unitary heat pumps:** These unitary ductless heat pumps sit inside an exterior wall. They are a very efficient kind of electric heating and cooling.



- ✓ Insufficient wiring capacity can result in dangerous overheating, tripped circuit breakers, blown fuses, or motor-damaging voltage drops.

### 8.22.3 Ductless Minisplit Heat Pumps

*SWS Details: 5.0108.3 Mini-Split System; 5.0101.1 Thermostat Replacement; 5.8801 Equipment Removal*

Ductless minisplit heat pumps contain an outdoor condenser and one or more indoor fan-coil units that heat or cool the rooms. Mini-split heat pumps are among the most efficient heating and cooling systems available, providing 2-to-4 watt hours of heating or cooling for each watt hour of electricity they use.

Select a system that is ENERGY STAR® certified or equivalent. Specify minisplits heat pumps as replacement HVAC solutions when they are appropriate, for example.

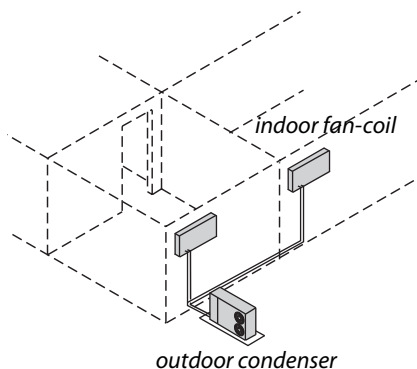

**Ductless mini-split heat pumps:**  
These systems have very high efficiency: 200% to 400%.

- Homes currently having no ducts.
- Homes with poorly designed or deteriorating ducts outside the thermal boundary or located in inaccessible areas, such as floor cavities.
- Isolated part of a building such as an addition or a bonus room.
- Very well-insulated, airtight, and shaded homes.
- Bedrooms needing cooling in homes with no central air conditioning.
- Masonry buildings being retrofitted to replace obsolete central space-conditioning systems (often steam).

## 8.23 EVALUATING DUCTED CENTRAL AIR-CONDITIONING SYSTEMS

*SWS Details: 5.0108.1 Air-to-Air Split System; 5.0108.2 Air-to-Air Package Unit; 5.0108.3 Mini-Split System; 5.0109 Clean and Tune; 5.0101.1 Thermostat Replacement; 5.8801 Equipment Removal*

An energy-efficient home shouldn't need more than a ton of air-conditioning capacity for every 1000 square feet of floor space. Evaluate window shading, attic insulation, and airtightness together with air-conditioner performance.

The following four installation-related problems are characteristic of central air conditioning systems.

1. Inadequate airflow
2. Duct air leakage
3. Incorrect charge
4. Oversizing

Refrigerant-charge tests and adjustment come after airflow measurement and improvement, and after duct testing and sealing. Manufacturers recommend that you verify adequate airflow before checking and adjusting the refrigerant charge.

The recommended airflow rate for central air-conditioning systems is between 350 CFM and 450 CFM per ton of refrigeration capacity. Heat pump airflow rate should be between 400 CFM and 450 CFM per ton.

**Table 8-16: Compiled Research Results on HVAC Performance<sup>a</sup>**

<b>Installation-Related Problem</b>	<b>%<sup>b</sup></b>	<b>Savings Potential</b>
Duct air leakage (avg. 270 CFM <sub>25</sub> ) <sup>c</sup>	70%	17% avg.
Inadequate airflow	70%	7% avg.
Incorrect charge	74%	12% avg.
Oversized by 50% or more	47%	2–10%

- a. Report sponsored by Environmental Protection Agency (EPA) and compiled from research from Multiple Field Studies
- b. Percent of tested homes found with a significant problem.
- c. The number of homes of the duct-leakage studies was around 14,000; the number for the other problems was over 400 each.

## 8.23.1 Central Air-Conditioner Inspection

*SWS Details: 5.0102.1 Condensate Removal; 5.0109.1 Condensers; 5.0109.2 Air Handlers; 5.0109.3 Evaporators; 5.0109 Clean and Tune; 5.0103 Refrigerant Loop*

Verify proper function and safety of the following system elements: fan motor, compressor, outdoor temperature sensors, bearings, safety devices, electrical disconnect, electrical wiring, contactors, capacitors, fan blades, refrigerant access ports.

On the equipment or in a conspicuous location, post a list of all systems and components inspected and services performed. Include in this list: service technician's name, contact information, and service date.

### Cleaning the Air Handler

Air conditioners move a lot of air, and that air contains dust. The filter in the air handler catches most large dust. However some dust travels around or through the filter, depending on the type of filter and its mounting assembly.

- ✓ Check the filter for dirt and replace it if dirty.
- ✓ Check the filter-mounting hardware for a close fit to avoid dirt moving around the filter and on to the blower and heat exchanger. Repair if necessary.
- ✓ Consider providing a supply of filters for occupants to change.
- ✓ Inspect the blower and clean it if dirty.
- ✓ Clean the blower compartment.

*See also "Ducted Air Distribution" on page 341.*

### Cleaning the Condenser Coil

The condenser coil outdoors isn't protected by a filter and is usually quite dirty. The goal of this procedure is to drive the dirt

out by spraying inside to outside. With high-pressure water, however, you can drive the dirt through the coil and into the cabinet where it drains out through drain holes.

- ✓ Clear foliage, grass, and other debris from within 3 feet of the unit.
- ✓ Inspect the condenser coil and know that it is probably dirty even if it looks clean on the outside. Take a flat toothpick and scrape between the fins. Can you scrape dirt out from between the fins?
- ✓ Apply a biodegradable coil cleaner to the outside of the coil. Then spray cold water through the coil, preferably from inside the cabinet. Many coils can tolerate a high-pressure spray but others require low-pressure spray to avoid bending the fins.
- ✓ Lubricate the blower motor.
- ✓ Straighten bent fins with a fin comb.



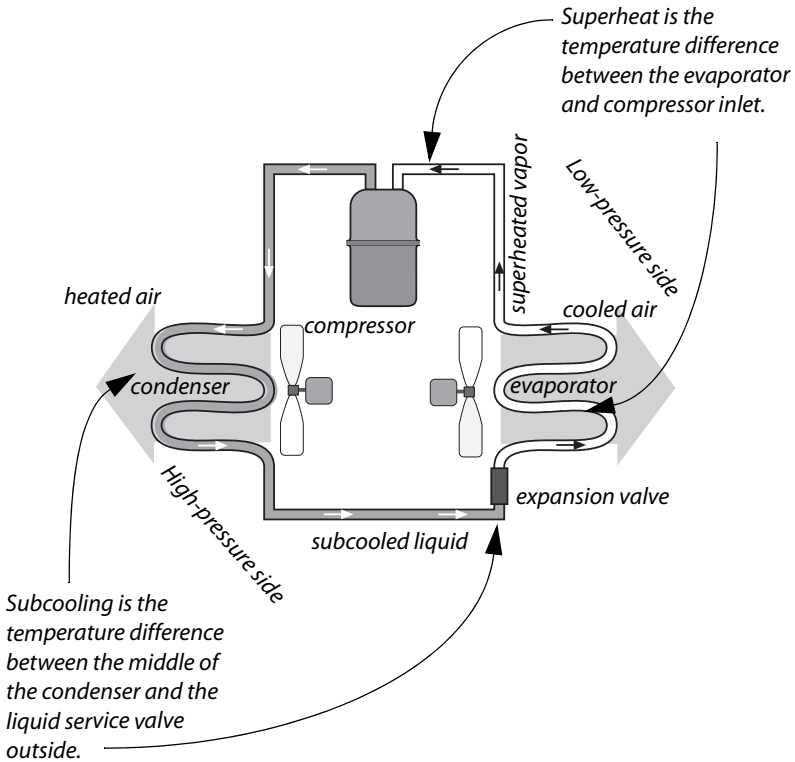

## Cleaning the Evaporator Coil

Dirt enters the filter, blower, and coil from the return plenum.

- ✓ Inspect the filter slot in the air handler or the filter grille in the return air registers. Do the filters completely fill their opening? Are the filters dirty?
- ✓ Inspect the blower in the air handler after disconnecting power to the unit. Can you remove significant dirt from one of the blades with your finger? If the blower is dirty, then the evaporator coil is also dirty.
- ✓ Clean the blower and evaporator. Rake surface dirt and dust off the coil with a brush. Then use an indoor coil cleaner and water to clean between the fins.
- ✓ Straighten bent fins with a fin comb.

## Air-Conditioning Evaporator Coil Temperatures

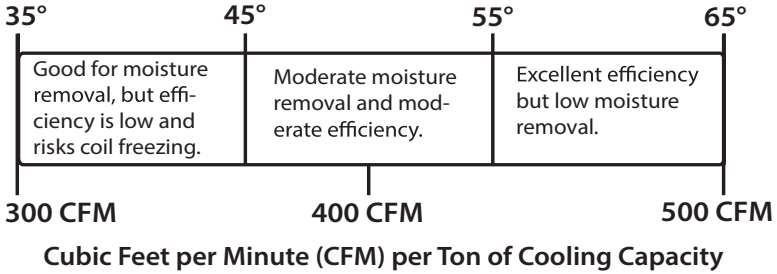

**Coil temperature and airflow:** The ideal airflow and coil temperature vary by the average relative humidity of a local climate.

### 8.23.2 Air-Conditioner Sizing

Calculate the correct size of an air conditioner before purchasing or installing it. The number of square feet of floor space that can be cooled by one ton of refrigeration capacity is determined by the home's energy efficiency. Air-conditioners provide cooling most cost-effectively when they are sized accurately and run for long cycles.

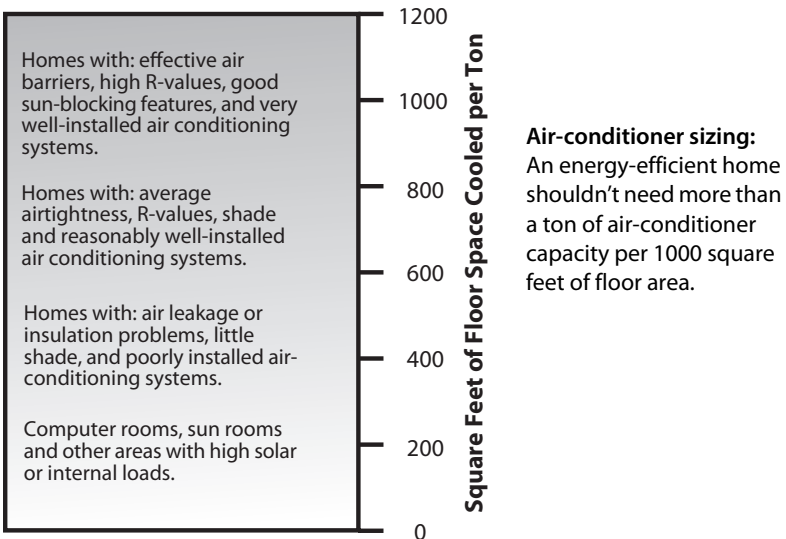

The cooling-cost reduction strategy should focus on making the home more energy efficient and making the air conditioner work more efficiently. Making the home more efficient involves shading, insulation, and air-leakage reduction. Making the air conditioner more efficient involves duct sealing, duct insulation, and a quality installation.

### 8.23.3 Duct Leakage and System Airflow

Unfortunately, duct leakage and poor airflow afflict most air-conditioning systems. The testing and mitigation of these problems was covered earlier in this chapter.

1. See *“Evaluating Duct Air Leakage”* on page 359.
2. See *“Ducted Air Distribution”* on page 341.

### 8.23.4 Evaluating Air-Conditioner Charge

*SWS Details: 5.0103.2 Refrigerant Charge; 5.0103.1 Refrigerant Lines; 5.0103.3; Thermostatic Expansion Valve (TXV); 5.0103.4 Compressors; 5.0109.3 Evaporators*

Air-conditioning replacement or service includes refrigerant charge-checking. The efficiency of the air-conditioning system is directly related to the amount of refrigerant. HVAC technicians evaluate refrigerant charge by two methods depending on what type of expansion valve the air conditioner has.

1. If the expansion valve has a fixed orifice, perform a superheat test.
2. If the valve is a thermostatic expansion valve (TXV), perform a subcooling test.

### Superheat Method Fixed-Orifice XV

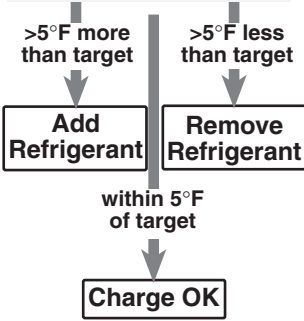

### Subcooling Method Thermostatic XV

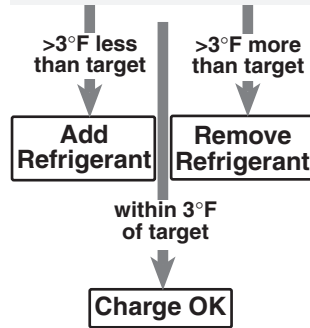

**Charge-checking:** Two methods help technicians judge whether the charge is correct. The remedy for incorrect charge is to either add or remove refrigerant.

## Checking and Correcting Charge

Superheat and subcooling tests indicate whether the amount of refrigerant in the system is correct, or whether there is too much or too little refrigerant. In the refrigerant is low, test for refrigerant leaks.

Perform charge-checking after you complete the airflow tests, airflow adjustments, and duct-sealing. Do charge-checking while the air conditioner operates during the cooling season.

- ✓ In the refrigerant is low, test for refrigerant leaks.
- ✓ Verify that indoor and outdoor temperatures are in the allowable testing range when you test.
- ✓ Add or remove refrigerant as necessary.
- ✓ Weigh in calculated refrigerant charge if outdoor conditions prevent accurate charge-checking according to manufacturer's refrigerant-weight specifications.
- ✓ Document your charge-checking and charge-correction and post the document on or near the equipment.

## 8.24 SWS ALIGNMENT

Field Guide Topic	SWS Detail
8.1.2: HVAC-System Education - Pg. 270	5.0501 Combustion Appliance Zones 5.0502 Combustion Air 5.0503 Appliance Venting 5.0504 Fuel Delivery
8.2.2: Leak-Testing Gas Piping - Pg. 272	5.0504 Fuel Delivery 5.0504.1 Natural Gas/Propane Fuel Piping
8.2.5: Evaluating Combustion Air at Worst-Case - Pg. 279	5.0501 Combustion Appliance Zones 5.0502 Combustion Air 5.0502.1 Combustion Air - Fuel-Fired Appliances
8.2.6: Mitigating CAZ Depressurization and Spillage - Pg. 281	5.0501.1 Isolate CAZ 5.0503.1 Fuel-Fired Appliance Venting 5.0502.1 Combustion Air - Fuel-Fired Appliances 5.0501 Combustion Appliance Zones
8.2.7: Combustion-Air-Related Solutions - Pg. 284	5.0501 Combustion Appliance Zones 5.0502 Combustion Air 5.0502.1 Combustion Air - Fuel-Fired Appliances 5.0501.1 Isolate CAZ
8.5.1: Combustion Furnace Replacement - Pg. 295	5.0108.4 Furnaces 5.8801 Equipment Removal 5.0104 Duct Installation 5.0105 Duct Repair 5.0106 Duct Sealing

<b>Field Guide Topic</b>	<b>SWS Detail</b>
8.5.2: Gas-Fired Heating Installation - Pg. 298	5.0108 Equipment Installation 5.0108.4 Furnaces 5.8801 Equipment Removal
8.5.3: Combustion Boiler Replacement - Pg. 301	5.0203.1 Boilers 5.0202 Distribution 5.0288.1 Boiler Room Water Drainage 5.0204.1 Fuel-Fired Boilers 5.8801 Equipment Removal
8.5.4: Oil-Fired Heating Installation - Pg. 305	5.0504.2 Oil Piping 5.0108 Equipment Installation 5.0203 Equipment Installation 5.0108.4 Furnaces 5.0203.1 Boilers 5.8801 Equipment Removal
8.5.5: Evaluating Oil Tanks - Pg. 307	5.0504.2 Oil Piping
8.6: Combustion Space Heater Replacement - Pg. 309	5.0301 Room Conditioning; 5.0301.3 Wall Furnace 5.05 Combustion Safety 5.0501 Combustion Appliance Zones 5.0502 Combustion Air 5.8801 Equipment Removal
8.6.2: Unvented Space Heaters - Pg. 310	5.8801 Equipment Removal
8.7: Gas Burner Safety & Efficiency Service - Pg. 311	5.8801 Equipment Removal
8.7.3: Testing and Adjustment - Pg. 313	5.05 Combustion Safety 5.0503 Appliance Venting 5.0501 Combustion Appliance Zones 5.0502 Combustion Air

<b>Field Guide Topic</b>	<b>SWS Detail</b>
8.9: Inspecting Furnace Heat Exchangers - Pg. 320	5.05 Combustion Safety 5.0501 Combustion Appliance Zones 5.0502 Combustion Air 5.8801 Equipment Removal
8.11: Inspecting Venting Systems - Pg. 326	5.0503 Appliance Venting 5.0503.1 Fuel-Fired Appliance Venting 5.0501 Combustion Appliance Zones
8.12: Chimneys - Pg. 329	5.0503 Appliance Venting 5.0503.1 Fuel-Fired Appliance Venting
8.12.1: Masonry Chimneys - Pg. 329	5.0503.1 Fuel-Fired Appliance Venting
8.12.2: Manufactured Chimneys - Pg. 333	5.0503.1 Fuel-Fired Appliance Venting
8.12.3: Chimney Terminations - Pg. 334	5.0503.1 Fuel-Fired Appliance Venting
8.13.1: Venting Fan-Assisted Furnaces and Boilers - Pg. 337	5.0503.1 Fuel-Fired Appliance Venting
8.13.2: Venting Sealed-Combustion Furnaces and Boilers - Pg. 339	5.0503.1 Fuel-Fired Appliance Venting
8.13.3: Sidewall Power Venting - Pg. 339	5.0503.1 Fuel-Fired Appliance Venting
8.14: Ducted Air Distribution - Pg. 341	5.01 Forced Air 5.0101 Controls 5.0104 Duct Installation 5.0105 Duct Repair 5.0106 Duct Sealing 5.0107 Duct Insulation

<b>Field Guide Topic</b>	<b>SWS Detail</b>
8.14.2: Solving Airflow Problems - Pg. 342	5.0104 Duct Installation 5.0105 Duct Repair 5.0106 Duct Sealing 5.0107 Duct Insulation
8.14.4: Evaluating Furnace Performance - Pg. 349	5.0108.4 Furnaces
8.14.7: Improving Forced-Air System Airflow - Pg. 355	5.0104.1 New Duct Components
8.15: Evaluating Duct Air Leakage - Pg. 359	5.0104 Duct Installation 5.0105 Duct Repair 5.0106 Duct Sealing
8.16: Sealing Duct Leaks - Pg. 369	5.0106 Duct Sealing 5.0106.1 General Duct Sealing; 5.0106.2 Duct Sealing - Spray Polyurethane Foam (SPF) 5.0105 Duct Repair
8.16.1: Duct Repair and Sealing Methods - Pg. 369	5.0106 Duct Sealing 5.0106.1 General Duct Sealing 5.0106.2 Duct Sealing - Spray Polyurethane Foam (SPF)
8.16.2: Sealing Return Ducts - Pg. 370	5.0106 Duct Sealing; 5.0106.1 General Duct Sealing; 5.0106.2 Duct Sealing - Spray Polyurethane Foam (SPF)
8.16.3: Sealing Supply Ducts - Pg. 372	5.0106 Duct Sealing 5.0106.1 General Duct Sealing
8.17: Duct Insulation - Pg. 375	5.0107 Duct Insulation 5.0107.1 General Duct Insulation
8.18.1: Boiler Efficiency and Maintenance - Pg. 378	5.0288.1 Boiler Room Water Drainage 5.0204.1 Fuel-Fired Boilers



<b>Field Guide Topic</b>	<b>SWS Detail</b>
8.18.2: Distribution System Improvements - Pg. 379	5.0204.1 Fuel-Fired Boilers 5.0202 Distribution 5.0202.1 Radiator Reflector 5.0202.2 Distribution Insulation
8.19: Steam Heating and Distribution - Pg. 382	5.0203 Equipment Installation 5.0202 Distribution 5.0202.1 Radiator Reflector 5.0202.2 Distribution Insulation 5.0201 Controls 5.0201.1 Thermostat Replacement 5.0204.1 Fuel-Fired Boilers 5.8801 Equipment Removal
8.19.1: Steam System Maintenance - Pg. 383	5.0204.1 Fuel-Fired Boilers 5.0288.1 Boiler Room Water Drainage
8.19.2: Steam System Energy Conservation - Pg. 384	5.0203 Equipment Installation; 5.0202 Distribution 5.0202.1 Radiator Reflector 5.0202.2 Distribution Insulation 5.0201 Controls 5.0201.1 Thermostat Replacement 5.0204.1 Fuel-Fired Boilers 5.8801 Equipment Removal
8.20: Replacing Thermostats - Pg. 388	5.0101.1 Thermostat Replacement 5.0201.1 Thermostat Replacement

<b>Field Guide Topic</b>	<b>SWS Detail</b>
8.21: Electric Heat - Pg. 390	5.0301 Room Conditioning 5.0101.1 Thermostat Replacement 5.8801.1 Decommissioning 5.0104 Duct Installation 5.0105 Duct Repair 5.0106 Duct Sealing
8.22.2: Room or Unitary Heat Pumps - Pg. 396	5.0301.1 Through-Wall and Window Units 5.0108.2 Air-to-Air Package Unit 5.8801 Equipment Removal
8.22.3: Ductless Minisplit Heat Pumps - Pg. 398	5.0108.3 Mini-Split System 5.0101.1 Thermostat Replacement 5.8801 Equipment Removal
8.23: Evaluating Ducted Central Air-Conditioning Systems - Pg. 399	5.0108.1 Air-to-Air Split System 5.0108.2 Air-to-Air Package Unit 5.0108.3 Mini-Split System 5.0109 Clean and Tune 5.0101.1 Thermostat Replacement 5.8801 Equipment Removal
8.23.1: Central Air-Conditioner Inspection - Pg. 401	5.0102.1 Condensate Removal 5.0109.1 Condensers 5.0109.2 Air Handlers 5.0109.3 Evaporators 5.0109 Clean and Tune 5.0103 Refrigerant Loop
8.23.4: Evaluating Air-Conditioner Charge - Pg. 405	5.0103.2 Refrigerant Charge 5.0103.1 Refrigerant Lines 5.0103.3 Thermostatic Expansion Valve (TXV) 5.0103.4 Compressors 5.0109.3 Evaporators

# CHAPTER 9: VENTILATION

This chapter discusses ventilation, fans, termination fittings, ducts, and passive vents.

This chapter covers these 4 types of ventilation.

1. Local ventilation
2. Whole-dwelling ventilation
3. Attic and crawl space ventilation
4. Ventilation for cooling

Before installing a mechanical whole-dwelling ventilation system, read *“Health and Safety” on page 21* for more information on controlling the sources of moisture and indoor air pollutants.

## 9.1 POLLUTANT CONTROL

Controlling pollutants at the source is the highest priority for good indoor air quality. Mechanical ventilation dilutes pollutants. However, ventilation is ineffective against prolific sources of moisture and pollutants. Ask these questions to evaluate pollution sources.

- Do the occupants have symptoms of dwelling-related illnesses? *See also “Health and Safety” on page 21.*
- Do sources of moisture like ground water, humidifiers, water leaks, or unvented space heaters cause indoor dampness, high relative humidity, or moisture damage? *See “Reducing Moisture Problems” on page 33.*
- Are there combustion appliances, especially unvented ones, in the living space?
- Do the occupants smoke?
- Are there paints, cleaners, pesticides, gas or other chemicals stored in the home?

## 9.1.1 Pollution-Control Checklist

Survey the home for pollutants before air-sealing or ventilating the home. Perform the following pollutant-control measures if needed.

- ✓ Repair roof and plumbing leaks.
- ✓ Install a ground-moisture barrier over bare soil in crawl spaces or dirt-floor basements.
- ✓ Verify that dryer ducts and exhaust fans move exhaust air to the outdoors.
- ✓ Verify that combustion-appliance vent systems operate properly.
- ✓ Move paints, cleaning solvents, and other chemicals out of the conditioned space if possible.
- ✓ Air seal between attached garages and a dwelling's conditioned areas.
- ✓ Don't leave un-vented space heaters as a primary heat source.

The dwelling's occupants are often the source of many home pollutants, such as candles, deodorizers, and pesticides. Educate the residents about minimizing such pollutants in their dwellings.

**Note:** Ventilation specialists now use the term “dwelling” to describe either a single-family home or multifamily living unit, ASHRAE 62.2–2016 now applies to both single-family and multifamily dwellings.

## 9.2 ASHRAE STANDARD 62.2–2016 VENTILATION

Most dwellings in North America currently rely on air leakage for ventilation. The American Society of Heating, Refrigerating, and Air Conditioning Engineers (ASHRAE) publishes ventilation standards for dwellings.

Their current standard, ASHRAE 62.2–2016, defines the roles and minimum requirements for mechanical and natural ventilation systems and the building envelope. The roles and requirements intend to provide acceptable indoor air quality in residential buildings.

## 9.2.1 ASHRAE 62.2–2016 Components

If you air seal dwellings during weatherization, you may need to install whole-dwelling mechanical ventilation systems under ASHRAE 62.2–2016, which has 3 components.

1. Whole-dwelling ventilation.
2. Local ventilation.
3. Natural infiltration credit.

This ventilation standard allows for natural infiltration (air leakage) to contribute toward the required whole-dwelling ventilation rate for single-family homes and horizontally attached multifamily buildings (but not vertically attached multifamily buildings).

## 9.2.2 Whole-Dwelling Ventilation Requirement

To comply with ASHRAE 62.2–2016, use either the formula or the table shown here to determine the whole-dwelling ventilation airflow requirement.

You can provide this mechanical airflow in 4 ways.

1. A dedicated exhaust or supply fan running continuously or cycling by automatic control.
2. A bathroom or kitchen exhaust fan running continuously or cycling by automatic control.
3. A central air handler drawing filtered outdoor air into its return.

4. A balanced ventilation system such as a heat-recovery ventilator (HRV) or energy-recovery-ventilator (ERV).

### Room Pressure Imbalances

If any room in the building exceeds  $\pm 3$  pascals pressure with reference to the common area when all interior doors are closed and while the ventilation system is operating, take action to reduce the pressure. Install transfer grilles or jumper ducts as needed to reduce the room to common area pressure difference to less than  $\pm 3$  pascals.

### Option 1: Finding the Airflow Requirement Using the Formula

If you want to install the minimum ventilation capacity, use these 3 steps to follow the formula option.

1. Determine the floor area of the conditioned space of the home in square feet ( $A_{\text{floor}}$ ).
2. Determine the number of bedrooms ( $N_{\text{br}}$ ).
3. Insert these numbers in the formula shown next.

$$\text{FAN AIRFLOW(CFM)} = 0.03\text{AFLOOR} + 7.5(\text{NBR} + 1)$$

*From ASHRAE Standard 62.2-2016*

### Option 2: Finding the Airflow Requirement Using the Table

**Note: If you know the number of occupants, compare the number of occupants with the number of bedrooms plus 1 and use the higher of those two values.**

You can also determine the required continuous fan airflow under ASHRAE 62.2–2016 using the table shown here.

**Table 9-1: Continuous CFM Fan Airflow Requirements**

Floor Area (ft <sup>2</sup> )	Number of Bedrooms				
	1	2-	3	4	5
Less Than 500	30	38	45	53	60
501-1000	45	53	60	68	75
1001-1500	60	68	75	83	90
1501-2000	75	83	90	98	105
2001-2500	90	98	105	113	120
2501-3000	105	113	120	128	135
3001-3500	120	128	135	143	150
3501-4000	135	143	150	158	165
4001-4500	150	158	165	173	180
4501-5000	165	173	180	188	195
From ASHRAE Standard 62.2-2016					

### Additional Ventilation Guidance

**If the ventilation airflow requirement is less than 15 CFM, ASHRAE 62.2–2016 exempts the mechanical-ventilation requirement.**

*Residential Energy Dynamics* provides a free online tool to help calculate ASHRAE 62.2–2016 ventilation rates.

Refer to the *ASHRAE standard* for more details, guidance, and exceptions that are beyond the scope of this field guide.

## 9.2.3 Local Exhaust Ventilation Requirement

There are two options for complying with the local ventilation requirements for kitchens and bathroom: demand-controlled exhaust or continuous exhaust.

1. For demand-controlled exhaust specify a minimum of 100 CFM for the kitchen, and 50 CFM for each bathroom. An operable window reduces a bathroom's ventilation requirement to 30 CFM.
2. For continuous exhaust specify a minimum of 20 CFM for each bathroom, and 5 ACH for the kitchen (based on volume).

### Local Exhaust Deficit

If the existing kitchen or bathroom ventilation doesn't meet the requirements stated here, you may adjust the whole-dwelling ventilation rate to compensate for the local airflow deficits. Follow these steps to calculate the local-ventilation deficit in CFM that must be added to the whole-dwelling ventilation rate.

1. Determine the total local exhaust ventilation requirement for all kitchens and bathrooms.
2. Measure the delivered airflow of existing kitchen or bathroom exhaust fans using flow hood, flow grid, or other airflow measuring device. Subtract this amount from the total local exhaust ventilation requirement.
3. If the local jurisdiction allows for operable windows to provide for local ventilation, subtract 20 CFM for each kitchen or bathroom that has an operable window.

The result of these steps is the local exhaust ventilation deficit in CFM. Add  $\frac{1}{4}$  of this deficit to the required whole-dwelling ventilation rate.





**Measuring fan airflow:** Use an exhaust-fan flow meter or a flow hood to verify the airflows through local exhaust fans and whole-building ventilation fans.

## 9.2.4 Infiltration Credit

ASHRAE 62.2–2016 allows for infiltration to contribute to the dwelling’s ventilation airflow. Infiltration can supply the entire whole-dwelling ventilation requirement for very leaky buildings. For moderately leaky buildings, infiltration may supply some of the building’s ventilation.

**Both single-family and multifamily buildings that are horizontally attached (low rise) are eligible for the infiltration credit.**

You can determine the amount of the infiltration credit with a blower-door test and weather data based on the building’s location. Calculating the infiltration credit without software is complicated. To simplify the calculations, use the [RED Calc Free](#) online tool and select “yes” for the “*Use the infiltration credit*” option.

## 9.3 FAN AND DUCT SPECIFICATIONS

This section covers fan and duct specifications for both local ventilation and whole-dwelling ventilation. Duct sizing, materials, and installation determine whether airflow meets the design airflow rate (CFM). Most existing exhaust fans and ventilation systems don’t achieve their design airflow because of installation flaws.

## 9.3.1 Fan Specifications

*SWS Detail: 6.0201.1 Surface Mounted; 6.0201.2 Kitchen Range Hoods; 6.0201.3 Inline and Multiport Fans; 6.0302.1 Individual Exhaust Fan Serving Entire Dwelling; 6.0302.2 Multiport Exhaust Fan Serving Multiple Dwellings*

We highly recommend continuous ventilation. Continuous ventilation simplifies design and control. Continuous ventilation also minimizes depressurization by allowing selection of the minimum-sized fan.

### General Fan and Ventilator Specifications

Exhaust fans, installed as part of weatherization work, must vent to outdoors and should include these features.

- ✓ Rated for continuous operation if the fan operates continuously.
- ✓ A weatherproof termination fitting, equipped with a screen, louver, or grille material over exterior termination with an opening size of no less than  $\frac{1}{4}$ -inch and no greater than  $\frac{1}{2}$ -inch.
- ✓ Unless the fan operates continuously, the fan housing or termination fitting should have a backdraft damper that opens in the direction of flow and closes when the fan is off.
- ✓ Noise rating must be no more than 2 sones.
- ✓ Ventilation efficacy must be more than or equal to 4 cfm/watt.
- ✓ The fan must move at least 50 cfm after installation, ducting, and termination are complete.

**Table 9-2: Fan Noise Limits ASHRAE 62.2–2016**

Fan	Noise Rating (sones)
Whole-dwelling fans	1 sone or less
Continuous Local Exhaust Fan up to 400 CFM	1 sone or less
Intermittent local ventilation up to 400 CFM	3 sones or less

### Fan Installation

Observe these procedures when installing ventilation fans.

- ✓ Install the fan or ventilator as close as possible to its termination.
- ✓ Orient the fan or ventilator housing so that the exit fittings face toward their duct termination fittings, using the shortest duct possible.



**Wrong-way fan orientation:** Turning the air stream 180 degrees substantially reduces airflow.



**Right-way fan orientation:** Air stream turns 90 degrees which is acceptable.

- ✓ Mount fan using mechanical fasteners so that fan housing doesn't shake, rattle, or vibrate when operating.
- ✓ Seal gap around fan housing and intake grills with a durable and compatible sealant, appropriate for indoor use.
- ✓ Remove an integral backdraft damper if the fan operates continuously.

- ✓ Don't inhibit back-draft-damper operation by installing screws that interfere with the damper's movement or by damaging the damper housing.
- ✓ Repair or replace the backdraft damper on an existing fan, if the damper doesn't open and close freely.
- ✓ If fan housing is in unconditioned space, enclose fan housing and insulate it to a minimum of R-8.
- ✓ Ensure fan and service disconnect switch are accessible for maintenance.
- ✓ Install in-line fans and multi-port ventilators in remote areas such as attics and crawl spaces and connect the fans to intake grilles in rooms.
- ✓ Isolate in-line fans and multi-port ventilators from framing to minimize noise.
- ✓ Measure the fan airflow to verify compliance with ASHRAE 62.2–2016.
- ✓ Install a MERV 6 filter in all ducted supply ventilation systems. *See “Evaluating Duct Air Leakage” on page 347.*

### Kitchen Range Hoods

- ✓ Select a fan that is rated a maximum of 3 sones at one or more airflow settings greater than or equal to 100 cfm.
- ✓ The fan must have a minimum efficacy of 2.8 cfm/watt.
- ✓ The fan must move at least 100 cfm intermittently or 5 kitchen air changes per hour (ACH) continuously after installation, ducting, and termination are complete.
- ✓ See *“Fan Installation” on page 421* for additional requirements.

### Inline and Multi-port Fans

- ✓ Select a fan that: has an electrically commutated motor (ECM) and an efficacy of 3.8 cfm/watt or more.

- ✓ Seal gaps around intake register boots with compatible sealant.
- ✓ See “*Fan Installation*” on page 421 for additional requirements.



**Two- or variable-speed fan:** An occupancy sensor toggles between speeds. A 6-inch outlet provides airflow for whole-building ventilation.



**Advanced 4-speed range fan:** Lower speeds for continuous ventilation and higher ones for spot ventilation.



**In-line fan in attic:** A Y exhausts airflow from two bathrooms for both local exhaust and whole-building ventilation.

**Outdoor-mounted kitchen fan:** Provides adequate power with less noise.



## 9.3.2 Intake and Exhaust Fittings

*SWS Detail: 6.0101.3 Exterior Intakes; 6.0101.2 Exhaust Terminations*

Termination fittings for intake and exhaust ducts must exclude pests and water. Termination fittings must comply with these specifications.

- ✓ Termination fittings must terminate outdoors and never in an attic, crawl space, garage, or within 10 feet of an intake fitting.
- ✓ The hole for termination fitting must leave no more than a  $\frac{1}{4}$ -inch gap around the fitting assembly.
- ✓ Termination fitting must direct water away from its opening.
- ✓ Flash or weather-seal termination fittings.
- ✓ Termination fittings must have insect screens over the openings. Insect screen openings must be between  $\frac{1}{4}$  and  $\frac{1}{2}$ -inch in size.
- ✓ The termination-fitting collar must be the same diameter as the exhaust or intake fitting on the fan.



**PVC elbow:** This screened PVC elbow is an intake fitting for an HRV.

- ✓ If the fan has no backdraft damper and the fan operates intermittently, install a termination fitting with a backdraft damper, to operate in the direction of airflow.

- ✓ Don't inhibit the backdraft damper operation if included in termination fitting — with fasteners, for example,

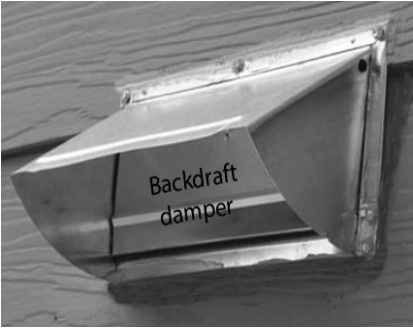

**Termination fitting:** If the fan operates intermittently, the termination fitting or the fan must have a backdraft damper.



**Backdraft damper in the kitchen-fan housing:** Many kitchen fans have integral backdraft dampers.

## Locating Termination Fittings

Locate termination fittings using these specifications.

- ✓ At least 6 inches above grade.
- ✓ At least 10 feet from another fan termination.
- ✓ Above local snow or flood line.
- ✓ At least 18 inches above a sloped asphalt based roof.
- ✓ Comply with local building authority requirements.
- ✓ Exhaust terminations must be at least 3 feet away from an operable window, an exterior door, or the property line.

### 9.3.3 Duct Sizing

Fans often fail to deliver their rated airflow capacity. Bends, un-straight flex duct, dirty grills, and backdraft dampers can reduce design airflow by 50% or more.

If you follow the sizing in this table, you may achieve the fan's rated airflow for short duct runs with a maximum of two elbows.



For more detailed duct-sizing recommendations, see [“ASHRAE 62.2 Duct Sizing” on page 568](#).

**Table 9-3: Round Duct Diameters (inches) for Desired Airflows**

Desired CFM	25	50	75	100	150	200
<b>Rigid</b>	4	5	6	7	8	9
<b>Flex duct</b>	5	6	7	8	9	10
Friction rate = 0.05; maximum equivalent length =100 feet						

### 9.3.4 Duct Materials and Installation

*SWS Detail: 6.0101.1 Ventilation Ducts; 6.0101.2; Exhaust Terminations; 6.0101.3 Exterior Intakes*

This sections covers SWS requirements and best practices for installing ventilation ducts connected to exhaust fans, ventilators, and air handlers.

*See also "Sealing Duct Leaks" on page 356.*

#### Rigid Duct Installation

Observe these best practices for installing rigid ventilation ducts.

- ✓ Prefer rigid smooth metal pipe (30 gauge or thicker) or plastic pipe (Schedule 30 or thicker) for ventilation duct.
- ✓ Limit elbows to a maximum of two per duct run.
- ✓ Use three equally spaced sheet-metal screws to fasten sections of round metal duct together.
- ✓ Join rigid duct sections so the edge of male end of a duct section isn't opposing airflow.
- ✓ Follow manufacturer's instructions to join other types of rigid ducts together.

- ✓ Seal all rigid-duct joints and seams with mastic, mastic and webbing, or metal tape, labeled UL181B or UL181B-M. *See “Sealing Duct Leaks” on page 356.*
- ✓ Support metal ducts with at least  $\frac{1}{2}$ -inch, 18 gauge strapping or at least 12-gauge galvanized wire. These supports must not be more than 10 feet apart.
- ✓ To prevent condensation, insulate all ducts to R-8 if they travel through unconditioned spaces. *See “Duct Insulation” on page 363.*
- ✓ Fasten PVC exhaust ducts together with approved PVC cement.

## Flexible Duct Installation

Observe these best practices for installing flexible ducts.

- ✓ Stretch flex duct and support it every 4 feet with a 1.5-inch duct support.
- ✓ Use tool-tensioned plastic tie bands to join both the inner liner and the outer liner of the flex duct to the rigid duct or a fitting on the fan or termination fitting.
- ✓ Install a screw to secure the flex duct and tie band to the metal duct between the tie band and the end of the metal duct.
- ✓ Flexible air duct material must meet UL 181, NFPA 90A/90B, International Mechanical Code, or the Uniform Mechanical Code.

**Flex duct joint to metal:** Seal the metal takeoff to the main duct. Seal the inner liner of the flex duct to the takeoff with a tool-tensioned tie band.

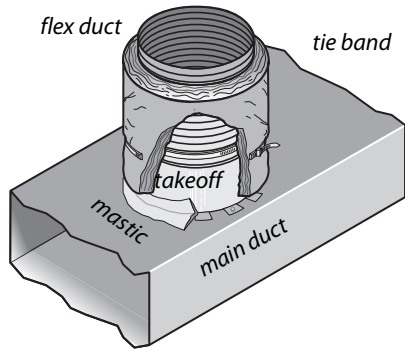

## 9.4 COMMISSIONING VENTILATION SYSTEMS

Commission new, retrofitted and serviced whole-dwelling ventilation systems to verify that the systems function according to design and the ASHRAE 62.2 standard.

- ✓ Verify that all the required ventilation-system components are present and connected correctly.
- ✓ Use airflow and pressure manometers that are appropriate for the operating range and that render accuracy of  $\pm 10\%$ .
- ✓ Measure total airflow, room airflows, and total static pressure to verify that these measurements are within design specifications.
- ✓ Adjust fan speed, dampers, and registers as necessary to bring airflow into conformance with design specifications.
- ✓ Verify that all sensors and controls function correctly.
- ✓ Check intermittent or continuous operation, verify sensor operation, record control settings, and observe the sequence of operation.

## 9.5 WHOLE-DWELLING VENTILATION SYSTEMS

This section discusses three options for design of whole-building ventilation systems.

- ✓ Exhaust ventilation
- ✓ Supply ventilation
- ✓ Balanced ventilation

See “*Fan and Duct Specifications*” on page 419.

We begin by discussing ducts for all types of ventilation systems.

## 9.5.1 Exhaust Ventilation

### *SWS Detail: 6.0302 Exhaust Ventilation*

Exhaust ventilation systems employ an exhaust fan to remove indoor air, which infiltrating outdoor air then replaces.

Installing a two-speed bathroom fan is a common ventilation strategy. The new fan runs continuously on low speed for whole-building ventilation. A built-in occupancy sensor switches the fan automatically to a high speed to remove moisture and odors from the bathroom quickly.

A remote fan that exhausts air from several rooms through ducts (4-to-6 inch diameter) may provide better ventilation for larger more complex dwellings, compared to a single-point exhaust fan.

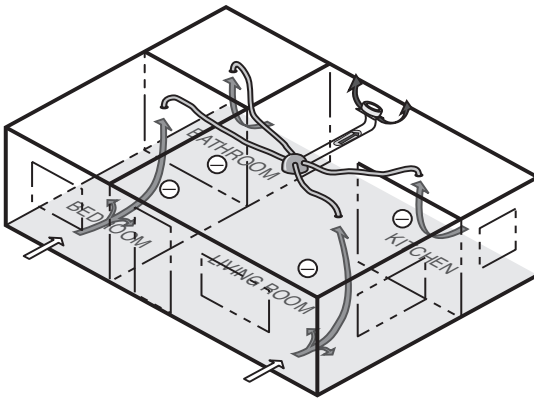

**Multi-port exhaust ventilation:** A multi-port ventilator creates better fresh-air distribution than a single central exhaust fan.



**Passive intake vent:** Exhaust ventilation systems often use passive vents to supply make-up air. This vent is close-able for very cold weather.

Exhaust ventilation systems create a negative house pressure, drawing outdoor air in through leaks in the envelope. This keeps moist indoor air from traveling through building cavities, which would occur with a positive building pressure. The negative building pressure reduces the likelihood of moisture accumulation in building cavities during the winter months in cold climates.

In hot and humid climates, however, this depressurization can draw moist outdoor air into the home through building cavities. Therefore we recommend supply ventilation for warm humid climates rather than exhaust ventilation.

### Single-Family Exhaust-Ventilation-System Specifications

- ✓ Fans must conform to *“Fan Specifications” on page 420.*
- ✓ Ducts must conform to *“Duct Materials and Installation” on page 427.*

- ✓ Termination fittings must conform to “*Intake and Exhaust Fittings*” on page 425.
- ✓ Use passive intake vents only if you can air seal the building to 1 ACH<sub>50</sub> or less. Otherwise the ventilation fans may draw their makeup air from air leaks rather than the passive vents.

### Multi-room Exhaust-Ventilation-System Specifications

- ✓ Evaluate the seal between the roof-mounted ventilator and the its ducts and the roof.
- ✓ Evaluate ventilation-duct chases for air leakage.
- ✓ Install backdraft dampers on intermittently operating systems.
- ✓ Measure airflow through registers to ensure a correct airflow rate. Adjust register size if necessary to decrease or increase ventilation airflow.
- ✓ Adjust ventilator airflow if building ventilation airflow is either excessive or insufficient.
- ✓ Insulate ducts outside the thermal boundary to R-8.
- ✓ Fire dampers must be accessible for inspection and testing.
- ✓ Educate occupants or building manager on maintenance procedures.

## 9.5.2 Supply Ventilation

*SWS Detail: 6.0301 Supply Ventilation; 6.0301.1 Fresh Air Intake In Forced Air System; 6.0301.2 Dedicated Air Handler for Multiple Dwellings*

Supply ventilation, using the home’s air handler, is never operated continuously as with exhaust ventilation because the furnace or heat-pump blower is too large and would over-ventilate the home and waste electrical energy. Supply ventilation may

not be appropriate for tight dwellings in very cold climates because supply ventilation can push moist indoor air through exterior walls, where moisture can condense on cold surfaces.

**Supply ventilation:** A furnace or heat pump with an outside air duct intake is used for ventilation with a control that ensures sufficient ventilation.

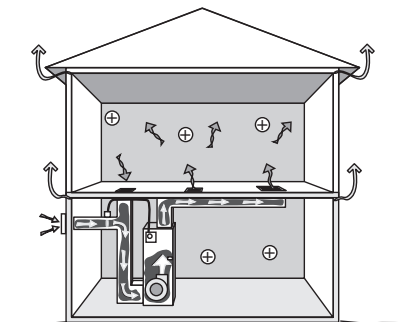

### Motorized Outdoor-Air Damper

A motorized damper that opens when the air-handler blower operates must control outdoor-air supply. The furnace/air conditioner heats or cools the outdoor air as necessary before delivering it to the living spaces.

The damper control estimates how much ventilation air is needed. The damper closes after the required amount of ventilation air has entered during heating or cooling. The control also activates the damper and the blower for additional ventilation air as needed without heating or cooling the air during mild weather.

### Supply-Ventilation System Requirements

Supply ventilation and sometimes balanced ventilation typically use the furnace or heat pump to move ventilating air. Comply with these specifications.

- ✓ The existing duct system must leak less than 10% of the air handler flow when measured at 25 pascals WRT outside.
- ✓ Install intake to pull air from the outdoors, not including unconditioned spaces such as attics, crawl spaces, and garages.

- ✓ Install intake above local snow or flood line and a minimum of 10 feet from contaminant sources or exhaust outlets.
- ✓ Install intake a minimum of 18 inches above an asphalt based roof.
- ✓ Install intake a minimum of 6 inches from grade.
- ✓ The outdoor air must flow through a MERV 8 or better air filter before flowing through heating and cooling equipment.
- ✓ Ducts must conform to *“Duct Materials and Installation” on page 427.*
- ✓ Termination fittings must comply with *“Intake and Exhaust Fittings” on page 425.*
- ✓ *See also “Fan Installation” on page 421.*

### 9.5.3 Balanced Ventilation

#### *SWS Detail: 6.0303 Balanced Ventilation*

Balanced ventilation systems exhaust stale air and provide fresh air through a ducted distribution system. Of the three ventilation systems discussed here, balanced systems do the best job of controlling pollutants in a building. However weatherization contractors seldom install them because of their high cost and high-maintenance demands.

Balanced systems move equal amounts of air into and out of the home. Most balanced systems incorporate heat-recovery ventilators or energy-recovery ventilators that reclaim heat and moisture from the exhaust air stream.



**Centralized balanced ventilation:**  
Air is exhausted from areas most likely to contain pollutants and fresh air is supplied to living areas.

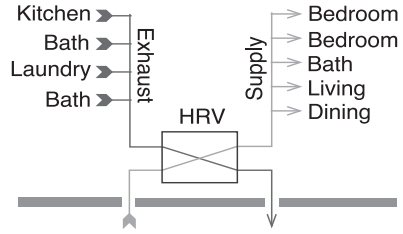

Balanced ventilation systems can improve the air quality and comfort of a building, but they require a high standard of care. Testing and commissioning are vital during both the initial installation and periodic service calls.

*See also "Supply-Ventilation System Requirements" on page 433.*

### Heat-Recovery and Energy-Recovery Ventilators

The difference between heat-recovery ventilators (HRVs) and energy-recovery ventilators (ERVs) is that HRVs transfer heat only, while ERVs transfer both sensible heat and latent heat (moisture) between air streams.

HRVs are often installed as balanced whole-building ventilation systems. The HRV core is an air-to-air heat exchanger in which the supply and exhaust air streams pass one another and exchange heat without mixing.

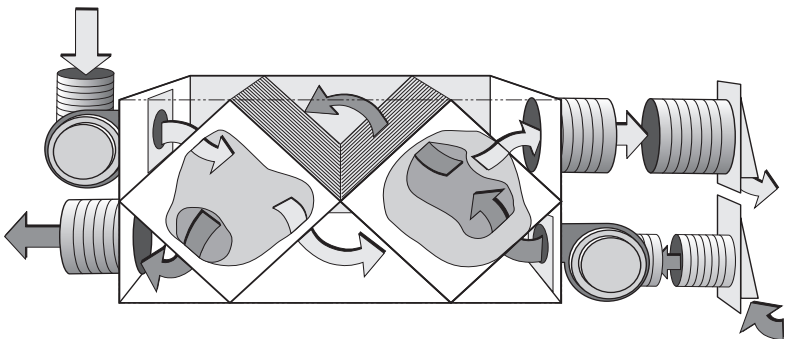

**Heat-recovery ventilator:** Heat from the exhaust air heats a plastic or aluminum heat exchanger, which in turn heats the fresh intake air. Two matched fans provide balanced ventilation.

## 9.6 GARAGE EXHAUST VENTILATION

### *SWS Detail: 6.0201.4 Garage Exhaust Fans*

Attached garages, particularly garages beneath living areas, may require exhaust ventilation to prevent indoor CO contamination. Only consider garage exhaust ventilation when all attempts to air seal the garage from the house were insufficient.

- ✓ Use pressure diagnostics to assist in determining the level of connection from the garage to the house and in making the determination for the need to add garage ventilation.
- ✓ For single family homes, install 100-CFM-capacity exhaust fans with an efficacy of 3.8 cfm/watt or more on the exterior wall or surface mounted inside the garage.
- ✓ Make sure the fan doesn't cause an unacceptable depressurization in a nearby CAZ. Provide pressure-relief if necessary.
- ✓ If the fan doesn't contain an integrated damper, install a damper that opens in the direction of the desired flow and closes when the system is off
- ✓ For larger multifamily garages, do thorough air sealing and then provide exhaust ventilation necessary to reduce indoor CO to a negligible level.
- ✓ Operate the fan using an occupancy sensor with a 15-minute runtime or continuous for larger garages as necessary.

*See also "Garages Underneath Living Areas" on page 209.*

## 9.7 MULTIFAMILY VENTILATION

*SWS Detail: 6.0301.1 Fresh Air Intake In Forced Air System; 6.0301.2 Dedicated Air Handler for Multiple Dwellings; 6.0304.1 Multi-Story Passive System; 6.0302.2 Multiport Exhaust Fan Serving Multiple Dwellings*

*Roof-mounted ventilator*

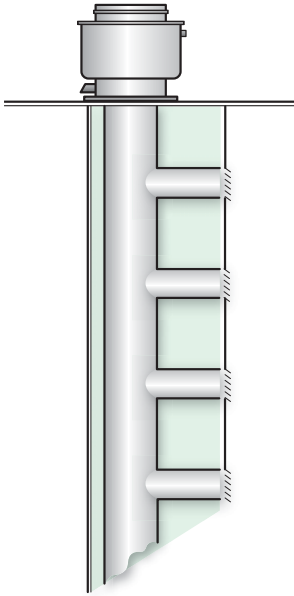

**Multifamily exhaust ventilation system:** Many multifamily buildings have vertically ducted exhaust ventilation systems with registers opening to kitchens and bathrooms on each floor.

Exhaust-only ventilation is the most common ventilation strategy for multifamily buildings. Vertical chases surround the ventilation ducts and installers cut holes in the chase for the ventilation registers/grills.

Forced-air HVAC systems also provide ventilation to multifamily buildings. The HVAC system delivers a portion of heated and cooled air as outdoor ventilation air.

See the following sections for more information on multifamily ventilation.

- [“General Fan and Ventilator Specifications” on page 420](#)
- [“Fan Installation” on page 421](#)
- [“Whole-Dwelling Ventilation Systems” on page 429](#)
- [“Air Filtration for Indoor Air Quality” on page 439](#)

## 9.7.1 Rooftop-Unit (RTUs) Economizer Ventilation

*SWS Detail: 6.0301.1 Fresh Air Intake In Forced Air System; 6.0301.2 Dedicated Air Handler for Multiple Dwellings*

Many buildings, particularly those with RTUs use economizers as their ventilation system. The delivered ventilation air is part outdoor air and part indoor air. The outdoor air dilutes pollutants and the indoor air provides mixing and moderation. Economizers don't normally have heat recovery or energy recovery function, so economizer ventilation has an energy penalty compared to a heat recovery ventilators.

Mild climates are ideal for ventilating with an economizer. When buildings use an economizer for ventilation, its dampers are open a small amount while the HVAC system is heating, cooling, or operating on the fan-only option. The fan-only control setting functions when you need ventilation, but not heating or cooling.

To run efficiently, the economizer requires a programmable thermostat that tracks the amount of ventilation air delivered during the free cooling mode and during the ventilation mode.

*See also "Supply-Ventilation System Requirements" on page 433.*

## 9.7.2 Adaptive Ventilation

The dwelling's residents can maintain good indoor air quality by using spot ventilation together with opening windows and doors. Depending on climate and season, residents can control natural ventilation to provide clean air, comfort, and energy efficiency.

- ✓ Choose windows and screen doors in strategic locations to ventilate using prevailing winds.
- ✓ Make sure that windows and screen doors, chosen for ventilation, open and close and have effective insect screens.

- ✓ Open windows to provide make-up air when an exhaust fan or the clothes dryer is operating.
- ✓ Understand that dust and pollen may enter through windows or screen doors and consider the consequences.

## 9.8 AIR FILTRATION FOR INDOOR AIR QUALITY

Ventilation isn't effective at removing small particles. Efficient air filters can reduce particle pollution in homes where particles are a air-quality problem. Suggest that clients run their air handlers during heavy air pollution in cities, proximity to dirt roads, seasonal forest fires, and other particle-generating events.

You can run an air-handler fan using the “fan only” setting on a thermostat. You can even program the fan to run for a period each day using a programmable thermostat.

The best places for filters are in forced-air HVAC systems or in balanced ventilation systems. Room air cleaners can also be effective particle removers if there is natural circulation among rooms.

Air filters affect the airflow and energy consumption of forced air HVAC systems and balanced ventilation systems. Before choosing the type of air filter and deciding to use the filter to remove particles, consider the filter's MERV rating and a building's need for particle removal.

### 9.8.1 Installing Filters for Outdoor Air

*SWS Detail: 6.0303.1 HRV/ERV Installation; 6.0301.2 Dedicated Air Handler for Multiple Dwellings; 6.0301.1 Fresh Air Intake In Forced Air System*

Provide filters for outdoor air supplied through ducted ventilation systems and observe these specifications.

- ✓ All fan-supplied outdoor air must pass through a filter before combining with conditioned air.

- ✓ Select a filter with a MERV rating of 8 or greater.
- ✓ The filter's pressure drop must not result in insufficient HVAC airflow.
- ✓ Install the filter on the inlet side of the fan.
- ✓ Make the filter accessible for changing or cleaning.
- ✓ Instruct the occupants or building manager on how and when to service the filter.

## 9.9 ATTIC VENTILATION

### *SWS Detail: 4.0188.2 Unconditioned Attic Ventilation*

Attic ventilation has the following functions.

- To keep the attic insulation and the attic's other building materials dry by circulating dry outdoor air through the attic.
- To prevent ice dams in cold weather by preventing snow melt and keeping the roof deck cold during the winter.
- To remove solar heat from the attic during the summer.

### 9.9.1 Attic Ventilation as a Solution for Moisture Problems

The best way to keep attic insulation dry is to air seal the attic floor to block moist indoor air from entering the attic. Adding attic vents may help to solve certain attic moisture problems.

- Seasonal moisture deposition.
- Ice damming in areas that currently lack high and low vents.

Adding attic vents won't solve these attic moisture problems.

- Moisture deposited by air leaks between the living space and the attic.

- Rain driven through attic vents.
- Roof leaks that dampen building materials beyond the capacity of the vents to dry.

## 9.9.2 When to Install Attic Ventilation

Install more attic ventilation only if you believe that the home needs one of the attic-ventilation functions listed above. Consider the following discussion points.

- Don't increase attic ventilation without first sealing attic air leaks and testing the attic air barrier for adequate airtightness.
- Avoid cutting new vents through the roof to avoid the possibility of roof leaks.
- Attic ventilation may not provide a useful function in some climates, such as persistently damp climates or windy, rainy climates.

**Important note:** The IRC offers an outright exception to ventilating attics if a code official determines that “atmospheric or climatic conditions” aren't favorable to attic ventilation.

## 9.9.3 Attic Ventilation Requirements

### *SWS Detail: 4.0188.2 Unconditioned Attic Ventilation*

Always vent exhaust fans directly to outdoors (through a soffit, gable, or wall) and never into a ventilated attic.

Net free area is the area of the vent minus the vent's solid obstructions such as screens and louvers. The net free area is typically 50% to 70% of the gross vent area.

The IRC and SWS state these requirements for attic ventilation.

- ✓ Provide a maximum ratio of one square foot of net free vent area to 150 square feet of attic area.

- ✓ The IRC requires only one square foot of net free area per 300 square feet of attic area for cool-climate ceilings, that have an interior vapor barrier, or well distributed ventilation (high and low), or with thorough air-sealing of the ceiling.
- ✓ Vents must have screens, with  $\frac{1}{4}$ -to- $\frac{1}{16}$  inch or less opening, to prevent the entry of pests and to reduce the entry of snow and rain.
- ✓ Vertical vents must have louvers to deflect rain.

**Soffit chute or baffle:** Install a maximum amount of insulation that the baffle allows. The chute prevents wind-washing and conveys the ventilation air over the insulation. The distributed vents ventilate the whole surface of the insulation and cool the whole roof in winter, preventing ice damming.

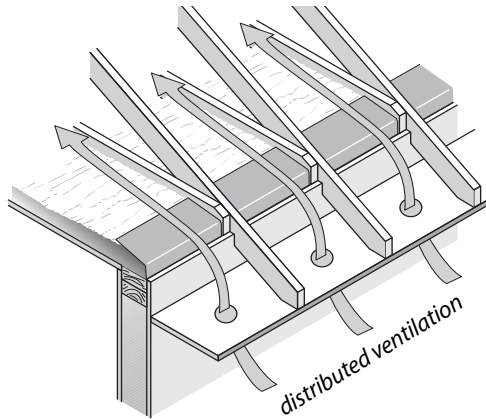

- ✓ Install vent chutes or baffles to prevent blown insulation and spray-foam insulation from entering the space between soffit vents and the attic.
- ✓ The baffles should allow the maximum amount of insulation to be installed over top plates without restricting ventilation paths. Vent chutes or baffles also help prevent the wind-washing of insulation caused by cold or hot air entering soffit vents. They should extend upwardly along the rafter to at least 4 inches above the finished insulation level.
- ✓ Don't install power ventilators to increase attic ventilation because of their energy consumption and doubtful effectiveness.



## High and Low Vents

A combination of high and low vents is the best way to move ventilating air through the attic. Soffit vents and ridge vents are an ideal combination for high-low attic ventilation. However, gable vents and roof vents, located high or low, also create acceptable ventilation.

**Low and high attic ventilation:** Distributed ventilation — high and low — is more effective than vents that aren't distributed.

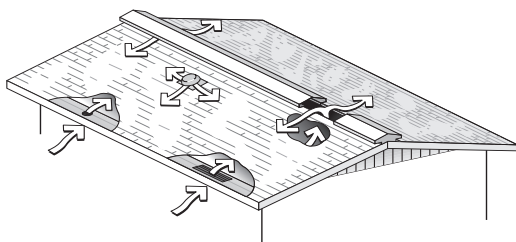

### 9.9.4 Power Ventilators

Power ventilators have limited value ventilating attics for air-conditioning energy savings or moisture mitigation.

- Power ventilators typically run longer than necessary.
- Power ventilators often consume more electricity than they save in reduced air conditioning.
- Power ventilators can pull conditioned air out through ceiling air leaks, counteracting their ventilating or cooling benefit.

### 9.9.5 Unventilated Attics

According to the IRC, new attics may be unventilated if the two conditions listed here are both met.

1. There is no vapor barrier installed in the ceiling.
2. The roof assembly is insulated with an air-impermeable insulation, such as high-density sprayed polyurethane,

to the bottom of the roof sheathing or foam board on the top side of the roof sheathing.

## 9.10 CRAWL SPACE VENTILATION

Before taking steps to improve crawl-space ventilation, comply with these requirements.

- ✓ The crawl space should have an access hatch or door that is adequate for a worker or resident to enter or exit.
- ✓ Correct grading, drainage, and gutter-and-downspout problems related to crawl-space moisture problems as specified in *“Ground-Water Drainage” on page 39.*
- ✓ Install a ground-moisture barrier as specified in *“Ground-Moisture Barriers” on page 44.*
- ✓ Install a sump pump with its discharge drained to daylight or a French drain to drain persistent standing water.

### 9.10.1 Naturally Ventilated Crawl Spaces

When insulating the floor, the crawl space is usually ventilated naturally through passive vent openings in the foundation wall. A ground-moisture barrier protects the floor insulation and other building materials from moisture. The vent openings can remove small amounts of moisture from the crawl space. Two specifications apply to ventilated crawl spaces.

1. A crawl-space with a ground-moisture barrier may have vent openings equal to 1 square foot of vent area to 300 square feet of crawl-space floor area. A minimum of two vents should be installed on opposite corners of the crawl space.
2. In a dry crawl space with a ground-moisture barrier, ventilation openings may be minimized to one square foot of net free ventilation area for every 1500 square

feet of crawl-space floor area, according to the 2012 IRC.

### 9.10.2 Power-Ventilated Crawl Spaces

The IRC allows you to seal the crawl-space vents completely when you insulate the foundation walls and power-ventilate the crawl space. These three specifications apply to power-ventilated or conditioned crawl spaces.

1. Remove moisture sources like standing water and install a seam-sealed and edge-sealed ground-moisture barrier, before sealing the foundation vents.
2. The IRC requires 1 CFM per 50 square feet of crawl space floor area in continuous powered exhaust ventilation. The IRC requires openings from the crawl space into the home so that make-up air comes from the living space. Some installers depend on floor air leakage to provide make-up air instead of intentional openings between the home and crawl space.
3. An acceptable alternative to option 2 is controlling the exhaust fan with a dehumidistat (moisture sensitive control). Such an exhaust fan typically operates continuously until the crawl space is dry and then intermittently after that. This option isn't IRC-approved.

### 9.10.3 Conditioned Crawl Spaces

The IRC requires 1 CFM per 50 square feet of crawl space floor area in conditioned supply air from a forced-air system. The IRC requires openings from the crawl space into the home for this option. The conditioned option requires code-compliant level of foundation insulation appropriate for the home's climate.

The conditioned crawl space, although allowed by the IRC, may be an ineffective moisture-and-energy solution for existing crawl spaces, especially in dry locations. In humid climates with

damp crawl spaces, the conditioned crawl space has succeeded in reducing moisture problems and even energy costs, when combined with an airtight ground-moisture barrier and foundation insulation.

## 9.11 VENTILATION FOR COOLING

Ventilation cooled dwellings for centuries before the invention of air conditioning. Ventilation is still an effective method for clients who can't afford air conditioning. Ventilate with fans during the coolest parts of the day and night, and close the windows during the hottest periods.



**Modern whole-house fans:**  
Modern models feature multiple speeds, tight-sealing insulated enclosures, and quiet operation.



### 9.11.1 Whole-House Fans

#### *SWS Details: 3.0103.3 Whole-House Fan - Operable*

Whole-house fans range in diameter from 24 inches to 42 inches, with capacities ranging from 3,000 to 10,000 cubic feet per minute (cfm). The capacity of the fan in cfm is rated for two different conditions: 1) free air; and 2) air constricted by 1 inch

of static pressure. The second condition is closer to the actual operating conditions of the fan in a home, and the cfm rating at 1 inch of static pressure may still be 10 to 30 percent higher than the actual volume of air moved by the installed whole-house fan. This means you should probably install a fan with a greater capacity than the sizing recommendations that follow.

Whole-house fans require 2 to 4 times the normal area of attic vent openings. Install a minimum of 1 square foot of net free area for every 750 cfm of fan capacity. However, more vent area is better for optimal whole-house-fan performance because the extra vent area increases airflow.

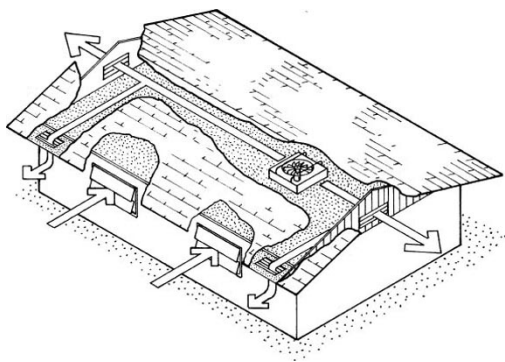

**Whole-house fan circulation:** the whole-house fan sucks air out of the house and exhausts it into the attic or through a gable wall. Cooler air enters the windows as make-up air for the fan.

## Sizing Whole-House Fans

To estimate the suitable size of a whole-house fan in cubic feet per minute,

1. First determine the volume of the building in cubic feet. Multiply the square footage of the floor area in your building that you want to cool by the height from floor to ceiling.
2. Take that volume and multiply by 15 to 40 air changes per hour, depending on how much ventilation you want.
3. Then, divide by 60 minutes to get cubic feet per minute of capacity for the whole-house fan.

$$\text{FAN AIRFLOW(CFM)} = \frac{\text{Building volume X 15-40 ACH}}{60}$$

### Seasonal Cover

Some fans come with a tight-sealing winter cover. If the fan doesn't have such a cover, or if the attic access doesn't allow you to cover the fan easily, then you can fabricate a cover for the grill on the ceiling. A seasonal cover, held in place with rotating clips or spring clips and sealed with foam tape, works well.

If the clients switch between air conditioning and cooling with a whole-house fan as the summer weather changes, build a tightly-sealed, hinged door for the fan opening that is easy to open and close when they switch cooling methods.

Comply with these specifications to install an operable cover.

- ✓ Install an operable cover for the fan enclosure that opens when the fan operates and closes when the fan turns off.
- ✓ Operable cover must seal airtight when closed.

**Air-sealed and dammed whole-house fan:** The whole-house fan must be dammed like an attic access hatch with air sealing and insulation to prevent excessive heat loss or gain.



### Insulation Dam

- ✓ Insulate fan enclosure to a minimum of R-20.

- ✓ Install insulation in full contact with the enclosure.

### 9.11.2 Window Fans

Window fans are best used in windows facing the prevailing wind or away from it to provide cross ventilation. Window fans can augment any breeze or create a breeze when the air is still. If the wind direction changes in your area, use reversible type window fans so you can either pull air into the home or push air out, depending on which way the wind is blowing. Experiment with positioning the fans in different windows to see which arrangement works best.

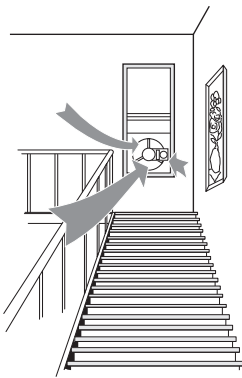

**Window fans:** Window fans circulate outdoor air when it is cooler than indoor air. The air circulation removes heat from the house.

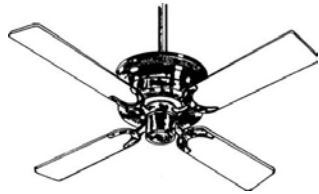

**Ceiling fans:** Ceiling fans cool people by convecting air next to their skin and helping evaporate sweat.

### 9.11.3 Air Circulation

#### *SWS Detail: 7.0188.1 Ceiling Fan Replacement*

Air circulating fans are very effective cooling energy savers. Air circulating fans may allow a 4 degree rise in the thermostat setting with no decrease in comfort.

Use circulating fans with air conditioners, evaporative coolers, whole-house fans, or by themselves. Circulating fans save cooling energy by increasing air movement over the skin to help occupants feel cooler.

## Ceiling Fans

Ceiling fans and various types of portable fans provide more comfort at less cost than any other electrically powered cooling strategy. Options include: small personal fans that sit on table-tops, or heavier units that sit on the floor or on metal stands with wheels.

Ceiling fans produce high air speeds with less noise than oscillating fans or box fans. High quality ceiling fans are generally more effective and quieter than cheaper ones. Ceiling fans are a key element to providing low-cost comfort to a home.

Comply with these specifications when selecting and installing a ceiling fan.

- ✓ Fan and lighting must be ENERGY STAR® qualified, equivalent, or better.
- ✓ Fan must be compatible with the existing switching and wiring configuration.
- ✓ Fan must be of similar functionality and size as the one you're replacing and carry a minimum of a 1-year warranty.
- ✓ Provide occupants/owners with user's manual, warranty information, installation instructions, and installer contact information.



## 9.12 SWS ALIGNMENT

Field Guide Topic	SWS Detail
9.3.1: Fan Specifications - Pg. 420	6.0201.1 Surface Mounted 6.0201.2 Kitchen Range Hoods 6.0201.3 Inline and Multiport Fans 6.0302.1 Individual Exhaust Fan Serving Entire Dwelling 6.0302.2 Multiport Exhaust Fan Serving Multiple Dwellings
9.3.2: Intake and Exhaust Fittings - Pg. 425	6.0101.3 Exterior Intakes; 6.0101.2 Exhaust Terminations
9.3.4: Duct Materials and Installation - Pg. 427	6.0101.1 Ventilation Ducts 6.0101.2 Exhaust Terminations 6.0101.3 Exterior Intakes
9.5.1: Exhaust Ventilation - Pg. 430	6.0302 Exhaust Ventilation;
9.5.2: Supply Ventilation - Pg. 432	6.0301 Supply Ventilation 6.0301.1 Fresh Air Intake In Forced Air System 6.0301.2 Dedicated Air Handler for Multiple Dwellings
9.5.3: Balanced Ventilation - Pg. 434	6.0303 Balanced Ventilation
9.6: Garage Exhaust Ventilation - Pg. 436	6.0201.4 Garage Exhaust Fans
9.7: Multifamily Ventilation - Pg. 436	6.0301.1 Fresh Air Intake In Forced Air System 6.0301.2 Dedicated Air Handler for Multiple Dwellings 6.0304.1 Multi-Story Passive System 6.0302.2 Multiport Exhaust Fan Serving Multiple Dwellings

<b>Field Guide Topic</b>	<b>SWS Detail</b>
9.7.1: Rooftop-Unit (RTUs) Economizer Ventilation - Pg. 438	6.0301.1 Fresh Air Intake In Forced Air System 6.0301.2 Dedicated Air Handler for Multiple Dwellings
9.8.1: Installing Filters for Outdoor Air - Pg. 439	6.0303.1 HRV/ERV Installation 6.0301.2 Dedicated Air Handler for Multiple Dwellings 6.0301.1 Fresh Air Intake In Forced Air System
9.9: Attic Ventilation - Pg. 440	4.0188.2 Unconditioned Attic Ventilation
9.9.3: Attic Ventilation Requirements - Pg. 441	4.0188.2 Unconditioned Attic Ventilation
9.11.1: Whole-House Fans - Pg. 446	3.0103.3 Whole-House Fan - Operable
9.11.3: Air Circulation - Pg. 449	7.0188.1 Ceiling Fan Replacement

# CHAPTER 10: BASELOAD MEASURES

## SWS Detail: 7 Baseload

Baseload energy consumption accounts for a large part of home energy use. This chapter discusses energy savings for refrigeration, entertainment, lighting, laundry, and water heating.

**Table 10-1: Levels of Household Electric Baseload Consumption**

Indicator	Low	Medium	High
kWh per Year	<4500	4500–8500	>8500
kWh per Month	<375	375–700	>700
kWh per Day	<12	12–23	>23
kWh per Person (Annual)	<1900	1900–3500	>3500

Doesn't include heating, cooling, or water heating. Assumes 2.4 persons per household and average annual consumption of 6500 kWh per household.

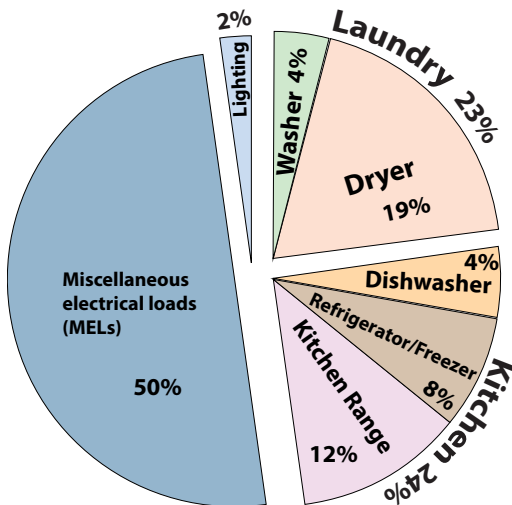

**Baseload Energy Consumption:** These baseload usage percents are, of course, different for every dwelling unit. However this chart gives an ideas of a typical distribution. Miscellaneous electrical loads or MELs can be up to half of total baseload consumption.

**Table 10-2: Electrical Consumption of Typical Appliances**

<b>Appliance</b>	<b>Annual usage (kWh)</b>	<b>Annual cost</b>
Ten-year-old refrigerator or freezer	1250	\$188
New ENERGY STAR refrigerator or freezer	500	\$75
Television	100–1000	\$15–\$150
Clothes dryer	1200	\$180
Well pump	500	\$75
Furnace fan	500	\$75
Computer	50–400	\$8–\$60
Hot tub, spa	2300	\$345
Water bed	1000	\$150
Data from Lawrence Berkeley Laboratory and others. Based on 15¢ per kilowatt-hour for electricity.		

## 10.1 REFRIGERATOR REPLACEMENT AND MAINTENANCE

Refrigerators built after 1993 use less electricity than refrigerators built before that year. Another efficiency increase occurred in 1999 in the refrigerator industry.

### 10.1.1 Refrigerator Replacement

#### *SWS Detail: 7.0101.1 Refrigerator and Freezer Replacement*

Comply with the following requirements when replacing refrigerators.

- ✓ The new refrigerator must fit the existing space.

- ✓ The new refrigerator must be 40% more efficient than the minimum federal standards or be labeled ENERGY STAR.
- ✓ The new refrigerator must have a minimum one-year warranty.
- ✓ Take refrigerators that are replaced to a facility that is licensed to reclaim their refrigerant and recycle the refrigerator's parts.
- ✓ No refrigerator, taken out of service, may be returned to service by sale, barter, or for free.
- ✓ Instruct the client about location and operation of energy controls such as the thermostats for the refrigerator and freezer.

Some clients use two or more refrigerators in their homes, and this practice results in high electricity usage. Suggest to these clients to consolidate food storage into a large single refrigerator.

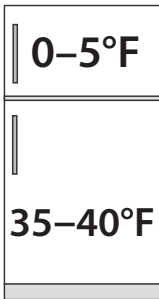

**Refrigerator clean and tune:** Clean coils and check temperatures. Adjust temperatures that are out of range.



## 10.1.2 Refrigerator Cleaning and Tuning

*SWS Detail: 7.0101.2 Refrigerator/Freezer Clean and Tune*

Cleaning and tuning an existing refrigerator can increase its efficiency. Follow these procedures.

- ✓ Clean dirt off clogged coils.
- ✓ Move objects that block airflow around the refrigerator, and ask the client to store the objects elsewhere.
- ✓ Measure refrigerator temperature and verify that it is between 35° and 40° F. Otherwise re-set the thermostat to this temperature range.
- ✓ Measure the freezer temperature, and verify that it is more than or equal to 0° F. If it is colder than 0°, re-set the freezer's thermostat to 0° F.
- ✓ Check the condensation-control switch. If the condensation control is on, the refrigerator door or door frame is being heated. Try turning the switch to “energy saver” which turns the heating elements off. If frost forms on the door, turn the control back on.
- ✓ Explain the function of the condensation control to clients. If the energy-saver setting isn't adequate for very humid weather, the occupants could toggle setting.

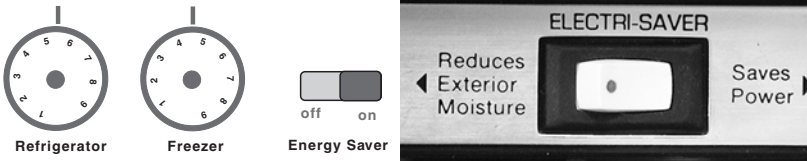

**Refrigerator energy controls:** Refrigerator and freezer temperatures aren't typically labeled in degrees, so there might be some trial and error in getting the setting within range. The condensation control is either on and heating the door perimeter or off and not heating the door perimeter.

### 10.1.3 Refrigerator Metering Protocol

Older refrigerators use from 1000 to 2000 kWh per year. Newer ENERGY STAR refrigerators use less than 400 kWh per year. You need a minimum of two hours to accurately measure refrigerator energy consumption using a recording watt-hour meter.

There are two (2) common options for evaluating refrigerator energy consumption for replacement.

1. The first option is to follow the metering procedure presented here.
2. If metering isn't practical, use the database housed in the Weatherization Assistant (WA) Software.

### Metering Accuracy Issues

A number of unusual circumstances could reduce the accuracy of the metering, including the following.

- A quantity of warm food recently placed in the refrigerator.
- Abnormally high or low ambient temperature. For example: refrigerators in garages during the summer or winter; or refrigerators in vacant homes where heating or cooling systems aren't operating.

#### Recording watt-hour meter:

Measures energy consumption over time. The better units can also calculate monthly consumption, or record maximum current draw to help identify the defrost cycle.

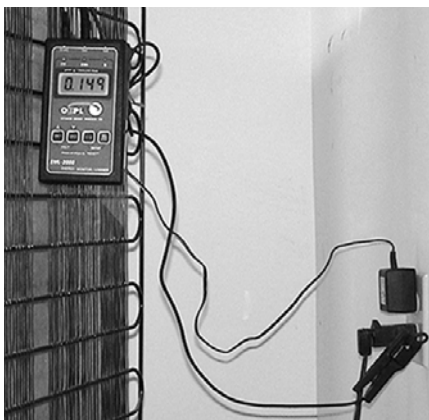

### Refrigerator Metering Procedure

If the refrigerator is an automatic-defrost model, you could measure an inaccurate reading if the unit goes into the electric defrost mode during the test period. The following test protocol includes provisions to prevent the defrost mode from activating.

1. Determine if the refrigerator is equipped with automatic defrost. This is usually stated on the manufacturer's data plate or on the outside of the unit. If the refrigerator is equipped with a manual defrost, proceed to step 3.
2. If the unit is equipped with automatic defrost, follow this sub-procedure.
  - a. Locate the defrost timer. This small electrical-control box is located in the refrigerator or behind the front kick-plate. The defrost timer may also be located on the rear of the unit.

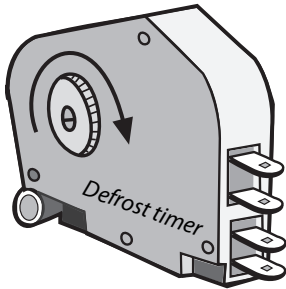

**Defrost Timer:** The defrost timer initiates the defrost cycle to melt ice at regular intervals.

- b. Open the defrost timer and locate the advance pinion. This shaft usually has a screwdriver slot to allow you to manually advance the timer.
      - c. Turn the timer clockwise (you can break the timer if you turn it counter-clockwise) until you hear a loud click. This turns the defrost heaters on. Turn it further until it clicks loudly again, turning the defrost heaters off.
      - d. You can now perform your measurement since the timer won't call for defrost heat again for several hours.
3. Connect the refrigerator to a recording watt-hour meter. Run the test for at least two hours. You don't need to stop at two hours, and a longer measurement is better. During the test, avoid opening the refrigerator, or do so briefly.



4. At the end of the test, read the kilowatt/hours of consumption measured by the meter. Divide this number by the number of hours in the test. This gives you the number of kilowatt-hours consumed each hour. Multiply this number times the total number of hours in a year (8760 hours per year). The product of this calculation is the annual kilowatt-hours of electrical usage.
5. **Remove the meter and plug the refrigerator back into its outlet.**

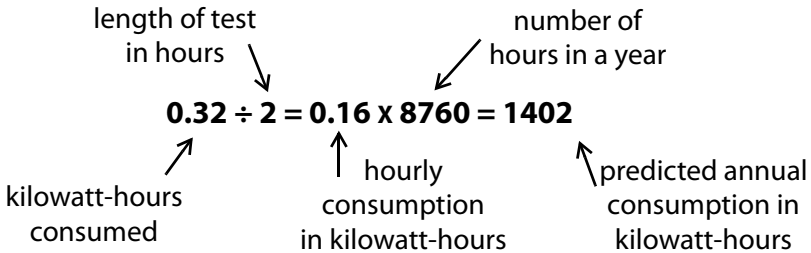

**Refrigerator consumption example:** In this example, a 2-hour measurement was performed. During this time, the appliance consumed 0.32 kilowatt-hours of electricity, or 0.16 kilowatt-hours per hour. The annual total of 1402 kilowatt-hours, calculated above, is well beyond the 450 kilowatt-hours per year consumed by today's most efficient refrigerators.

**Table 10-3: Kilowatt-Hours per Hour & Kilowatt-Hours per Year**

kWh/hour	kWh/year	kWh/hour	kWh/year
0.23	2000	0.16	1400
0.22	1900	0.15	1300
0.21	1800	0.14	1200
0.19	1700	0.13	1100
0.18	1600	0.11	1000
0.17	1500	0.10	900

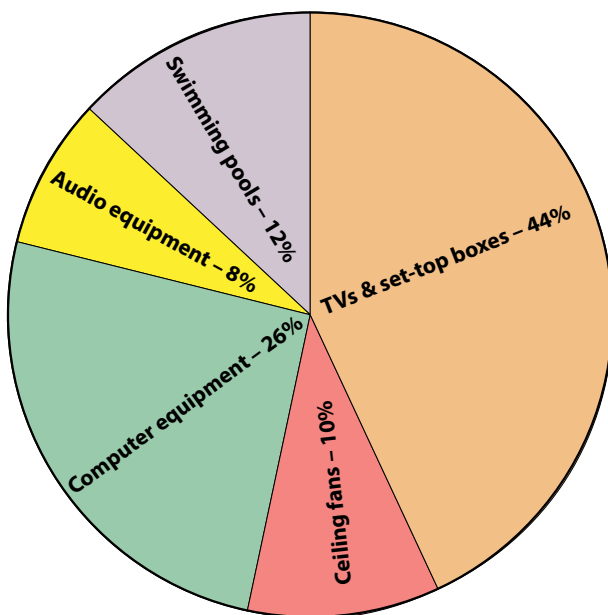

**Miscellaneous Electrical Loads (MELs):** MELs consume from 1000 to 3000 kWh per household, a huge increase over households 20 or even 10 years ago. The explanation is more TVs with set-top boxes, computers, and electronic entertainment.

## 10.2 ELECTRONIC ENTERTAINMENT AND COMPUTERS

*SWS Detail: 7.0102 Electronics; 7.0102.1 Consumer Electronics Replacement*

Change settings for the plan: Power saver

Choose the sleep and display settings that you want your computer to use.

 Turn off the display:

 Put the computer to sleep:

[Change advanced power settings](#)

[Restore default settings for this plan](#)

**Computer power settings:**

Go to your computer's control panels and set the *power-saver control* to rest the display and sleep the computer after some chosen time of inactivity.

The purpose of this section is to help clients conserve electricity and identify major electricity users among their computer and entertainment systems. These measures must not be charged to DOE or LIHEAP funds.

- ✓ Advise clients to buy equipment labeled ENERGY STAR.
- ✓ Advise clients to buy electronic equipment that doesn't need to be left on when not being used.
- ✓ Recommend power strips that can be turned off when electronic equipment isn't being used.
- ✓ Standby losses for electronic equipment should be one watt or less.
- ✓ Typical Set-top boxes consume between 30 and 50 W even when they're switched off. Most energy efficient models still consume more than 10 W when they're off.
- ✓ Read the operating manual and enable all energy-saving features of an appliance. Explain the energy-saving features to the client.
- ✓ Verify that clients have operating instructions for their electronic equipment or that they know how to access instructions using the Internet.
- ✓ Recycle or dispose of equipment using principles of the Environmental Protection Agency (EPA) Responsible Recycling (R2) Initiative.



**Smart plug strips:** A variety of plug strips with built-in controls are now available. The plug strips interrupts power to appliances by remote control, on a time schedule, or by sensing occupancy.

## 10.3 LIGHTING-EFFICIENCY IMPROVEMENTS

*SWS Detail: 7.0103 Lighting; 7.0103.2 Lighting Reduction*

Lighting-efficiency improvements include bulb (lamp) replacement, daylighting, fixture replacement, and energy-efficient lighting controls.

### 10.3.1 LEDs versus CFLs

*SWS Detail: 7.0103.2 Lighting Reduction; 7.0103.1 Lighting Replacement*

CFLs were the dominant energy-saving alternative to incandescent for at least 20 years. Now, LEDs have largely captured the lighting-retrofit market because of their superior energy efficiency, long life, and low cost.

CFLs are still a viable choice, especially when you have a large stock of them. However the future now belongs to LEDs. The more LEDs that WAP installs, the more energy savings WAP achieves from lighting retrofits.



Cree.com



*LED recessed-light replacement*



*LED bulb*

**LED lamps and fixtures:** LEDs now dominate the lighting-retrofit market because of their superior energy efficiency and long life.

## 10.3.2 Home Lighting Retrofit Equipment

*SWS Detail: 7.0103.2 Lighting Reduction; 7.0103.1 Lighting Replacement; 7.0103.3 Ballast Replacement; 7.0104 Lighting Controls*

Consider the following specifications when retrofitting lighting equipment.

- ✓ Ask the client about their lighting usage, and explain the electrical savings potential for switching to light-emitting diodes (LEDs).
- ✓ Demonstrate a LED bulb to the client if they're hesitant about replacing their incandescent light bulbs.
- ✓ Select the type of LED and its wattage, according to its use and the client's accustomed light level.
- ✓ Consider the color temperature of the LED — warm versus cool.

- ✓ Turn on each LED after installation to ensure that it operates. Make sure that the client is satisfied with the light level.
- ✓ Replace a halogen-torchiere lamp holder with an LED conversion kit for the torchiere.
- ✓ Replace incandescent bulbs in candelabra fixtures with LEDs designed for this purpose.
- ✓ Install bulbs, fixtures, and controls designed for their intended application (for example: enclosed, dimmable, indoor, outdoor).
- ✓ Select bulbs, fixtures, and controls to provide the brightness and light quality required in that application (for example: task lighting, walkway lighting, night lights).
- ✓ All bulbs, fixtures, and controls must be ENERGY STAR® rated where applicable.
- ✓ Bulb wattage must not exceed rated wattage of the light fixture.
- ✓ Select bulb replacements based on expected life span, light quality, and lifetime energy use.
- ✓ Install occupancy sensing controls where appropriate.
- ✓ All bulbs, fixtures, and controls must be UL-approved and installed according to local code(s) and *NFPA 70 National Electric Code*
- ✓ Inform clients about proper recycling of fluorescent bulbs by stores, municipal waste departments, or other recycling organizations.
- ✓ Replace fluorescent light ballasts containing polychlorinated biphenyls (PCBs) according to the EPA's *Healthy Indoor Environment Protocols for Home Energy Upgrades*.



*LED candle*



*LED  
torchiere*

**LED lamps:** These advanced lamps use less than one-third of the electricity of the incandescent lamps they usually replace, and they last about ten times as long.

### 10.3.3 Reducing Fixture Wattage

*SWS Detail:7.0103.2 Lighting Reduction; 7.0103.1 Lighting Replacement; 7.0103.3 Ballast Replacement; 7.0103.4 Exit Sign Replacement; 7.0103.5 Emergency Lighting Replacement; 7.0103.6 Security Lighting*

Many rooms and common areas of multifamily buildings are unnecessarily over-lit. Areas that, by reasonable standards, require between 2 and 15 footcandles sometimes measure 20 to 60 footcandles.

Measure light levels before and after lighting retrofits. Occupants very seldom notice light-level reductions unless they know it happened.

#### General Fixture Retrofit

- Clean lenses and fixtures as part of the retrofit.
- Consider replacing incandescent and CFL bulbs with LEDs of a reduced lumen output.

- Retrofit point-source fixtures in over-lit areas with the same bulb type of a lower wattage and reduced lumen output.
- Replace existing fixtures in intermittently occupied areas with fixtures equipped with integral occupancy sensors if available.



**Footcandle meter:** Measure light levels in rooms and outdoor areas before and after lighting retrofits.

## Multifamily Fluorescent Fixtures

Multifamily stairs, parking garages, hallways, and lobbies are some of the most over-lit areas. Fluorescent fixtures light many of these areas. Consider these retrofits depending on the building's budget and the cost of electricity.

- Clean lenses and fixtures as part of the retrofit.
- Replace T-12 lamps with T-8 lamps.
- Remove up to two tubes from 4-lamp fixtures or 1 lamp from a 2-lamp fixtures.
- Modernize existing magnetic-ballast fixtures to the Super T-8 standard.
- Replace fluorescent fixtures with LED fixtures with reduced lumen output.



### 10.3.4 Light Color

Some clients are sensitive to light color. Manufacturers design and label commercial lamps with a color temperature (°K), depending on their “coolness” or “warmness.” People perceive colors at the blue-green end of the color spectrum as cool and those at the color spectrum’s red end as warm. Morning sunlight from the north is a cool blue-green and from southwest evening sunlight is a warm red-yellow.

Office workers perform better under cool light sources for visual tasks, since cool light produces better illumination and contrast at the printed page, workbench, or other task. People often prefer warm light sources for living spaces, because warm light seems to many to illuminate people’s skin and clothing in a flattering way.

Light color is a complex topic of color measurement by degrees Kelvin (°K) through a range of 3000°K (very warm) to 5000°K (very cool). The full discussion of this range of options is more relevant for commercial and industrial buildings than residential buildings. That discussion goes beyond the scope of this field guide.

### 10.3.5 Daylighting

#### *SWS Detail: 7.0103.7 Daylighting*

Use daylighting as appropriate to save electricity.

- ✓ Replace, adjust, or repair window coverings to maximize useful daylight where appropriate.
- ✓ Design and use active and passive day lighting where appropriate.

**Table 10-4: Recommended Horizontal Light Levels (FC)**

<b>Building Area</b>	<b>Recommended Footcandles (FC)</b>
<b>Corridors and stairways</b>	5-10
<b>Kitchens and work areas</b>	25-50
<b>Dining rooms and bedrooms</b>	10-20
<b>Common bathrooms</b>	5-10
<b>Parking garages</b>	1-2
<b>Lobbies</b>	5-10
<b>Outdoor walkways</b>	1-2
<b>Outdoor building entrance</b>	2-5

## 10.4 CLOTHES-WASHER SELECTION/REPLACEMENT

### *SWS Detail: 7.0105 Laundry*

Observe the following standards to minimize the energy consumption of clothes washers. This measure must not be charged to DOE or LIHEAP funds.

### 10.4.1 Clothes-Washer Selection

#### *SWS Detail: 7.0105.1 Washing Machine*

Comply with these requirements when selecting a new clothes washer.

- ✓ Select clothes washers that meet or exceed ENERGY STAR® and WaterSense® specifications.

- ✓ Maintain adequate clearance around appliance when fit into the available space, so the washer doesn't block access to cabinets and light switches.
- ✓ Appliance must be covered by a minimum one-year warranty.
- ✓ Standby losses for clothes washers must be one watt or less.

## 10.4.2 Clothes-Washer Installation

### *SWS Detail: 7.0105.1 Washing Machine*

Comply with these requirements when installing a new clothes washer. This measure must not be charged to DOE or LIHEAP funds.

- ✓ Install clothes washers in accordance with manufacturer specifications, (including leveling, plumbing connections, electrical connections) and meet all applicable codes.
- ✓ Install shut-off valves on hot and cold supply water if not already present.
- ✓ If located in conditioned or finished area, install an overflow pan and drain the pan to a safe location
- ✓ Air seal any penetrations to the exterior of the home created by the washer's installation.
- ✓ Demonstrate energy-related appliance controls to the occupant.
- ✓ Provide specific information about proper maintenance of the washer to the occupant.
- ✓ Provide warranty information, operation manuals, and installer name to the owner.

## 10.5 CLOTHES DRYERS

*SWS Detail: 7.0105 Laundry*

The following standards minimize the energy consumption of clothes dryers. This measure must not be charged to DOE or LIHEAP funds.

### 10.5.1 Clothes-Dryer Selection

*SWS Detail: 7.0105.2 Clothes Dryer*

Comply with these requirements when selecting a new clothes dryer. This measure must not be charged to DOE or LIHEAP funds.

- ✓ Maintain adequate clearance around appliances to avoid blocking cabinets and light switches.
- ✓ Verify that appliances have a minimum one-year warranty.
- ✓ Select equipment with features that reduce peak electric demand and energy use.
- ✓ Standby losses for clothes dryers must be one watt or less.

### 10.5.2 Clothes-Dryer Installation

*SWS Detail: 6.0202.1 Clothes Dryer; 7.0105.2 Clothes Dryer*

Install the appliance in accordance with manufacturer specifications and all applicable codes.

Consider these requirements when replacing clothes dryers. This measure must not be charged to DOE or LIHEAP funds.

- ✓ Demonstrated energy-related dryer controls to the occupant.
- ✓ Provide specific information of the proper maintenance of the equipment to the occupant.

- ✓ Provide warranty information, operation manuals, and installer contact information to the occupant.
- ✓ Recycle or remove and dispose of replaced appliances in accordance with local regulations, including older equipment switches containing mercury.

If existing venting doesn't meet manufacturer specifications, code, or the following criteria, install new venting using these specifications. This measure must not be charged to DOE or LIHEAP funds.

- ✓ Vent all dryers, other than condensing dryers to the outdoors.
- ✓ Vent appliance to the outdoors using metal-to-metal or UL listed foil-faced dryer vent.
- ✓ Use only metal clamps on semi-rigid metal and UL listed foil-type vent pipes.
- ✓ Install a pest screen at the termination.
- ✓ Insulate at least 3 feet of the vent closest to the home's exterior to a minimum of R-6.
- ✓ If a combustion appliance is used, perform combustion-safety testing as described in "[Combustion-Safety Evaluation](#)" on page 269.
- ✓ Seal penetrations to the outdoors created by the appliance installation to an airtight condition.

### 10.5.3 Clothes-Dryer Service and Venting

*SWS Detail: 6.0202.1 Clothes Dryer; 7.0105.2 Clothes Dryer*

Clogged clothes-dryer vents are a leading cause of house fires. The drying time of a load of laundry depends first on the dryer installation. The original installation can also cause excessive drying time when flexible vents are excessively long, kinked, or restricted in some other way. The amount of lint in the dryer,

vent piping, and vent termination also affects dryer safety and efficiency. Lint builds up over time and slows drying time and increases the fire hazard.

Vinyl flexible dryer vent isn't an approved dryer vent material. To reduce energy cost and improve safety, replace vinyl flex duct with metal flexible dryer vent.



**Lint collection:** After years of operation, lint coats flexible pipe and eventually blocks the airway.

## Service Procedures

As part of the client education process, recommend servicing clothes dryers to prevent fires, reduce drying time, save energy and reduce lint build-up. Unless the clients are capable, a service professional may be required to adequately clean lint from a dryer and vent.

Observe the following suggestions when servicing clothes dryers to prevent fires, reduce drying time, improve energy efficiency, and reduce lint build-up.

- ✓ Unplug the clothes dryer before making any improvements.
- ✓ Remove the vent pipe and vent termination and clean all lint out of them.
- ✓ Clean lint out of the electric heating elements and the airway around them.

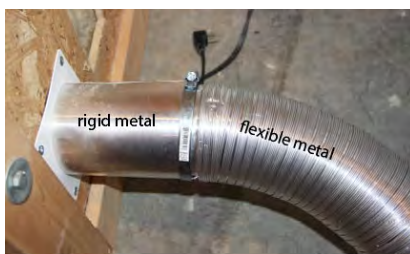

**Vent and termination:** Use rigid metal vent pipe if at all possible. Or use flexible metal vent and not foil vent when flexibility is required.



## Dryer Exhaust Venting Requirements

Follow these venting requirements for clothes dryers when servicing dryers.

- ✓ Clean lint from the dryer and vent system when making modifications or improvements to the dryer vent system.
- ✓ Pipe dryer vents with 4-inch-diameter rigid aluminum or galvanized pipe whenever and wherever possible.
- ✓ Don't use screws or rivets to join rigid pipe sections because they collect lint. Join and seal the sections with pipe clamps or UL 181B tape.
- ✓ Exhaust venting duct must be supported at a maximum of 4-foot intervals.
- ✓ Use short, stretched pieces of flexible metal dryer vent, labeled UL 2158A, to connect the dryer to the rigid vent through difficult framing or to allow dryer to be moved in and out. Make connections using rigid fittings installed male-to-female in the direction of exhaust flow to prevent lint build-up.
- ✓ Fasten UL listed foil-type vent or semi-rigid sheet metal to rigid metal with clamps.
- ✓ Fasten other specialized duct fittings according to manufacturer's specifications.

- ✓ Seal duct connection with foil tape labeled UL 181B or 181B-M.
- ✓ Install a booster fan for dryer ducts exceeding 35 feet in duct equivalent length. When calculating duct length, add 5 feet for each 90° bend and 2.5 feet for each 45° bend.
- ✓ Provide make-up air if you measure excessive depressurization or if the dryer moves 200 CFM or more of airflow.

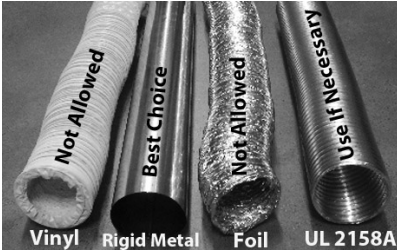

**Dryer vent types:** Clothes dryer energy-efficiency depends on the type of vent material and the equivalent length of the vent.

## 10.6 WATER-HEATING ENERGY SAVINGS

*SWS Detail: 7.02 Water Conservation; 7.03 Water Heating*

For safety information on combustion water heaters, see [“Carbon Monoxide \(CO\) Testing” on page 271](#).

The most important tasks in evaluating hot water energy savings are determining the water heater’s insulation level, measuring the shower’s flow rate, and measuring the water temperature.



**Table 10-5: Water Heating Consumption According to Family Size**

<b>Number of Residents</b>	<b>Annual kWh</b>	<b>Annual Therms</b>	<b>Gallons Per Day</b>
<b>1</b>	2700	180	25
<b>2</b>	3500	230	40
<b>3</b>	4900	320	50
<b>4</b>	5400	350	65
<b>5</b>	6300	410	75
<b>6</b>	7000	750	85

Author's interpretation of data from single-family homes with existing water heaters from Energy Information Administration, Lawrence Berkeley Laboratory, *Home Energy Magazine*, and others.

## 10.6.1 Water-Saving Shower Heads and Faucet Aerators

### *SWS Detail: 7.0201.1 Low-Flow Devices*

Most families use more hot water in the shower than for any other use. A low-flow shower head reduces this consumption.

- ✓ Water-saving shower heads must be rated for a flow of 2.5 gallons per minute or less.
- ✓ Water-saving aerators must be rated for a flow of 2.2 gallons per minute or less.
- ✓ Use caution in removing the existing shower head or aerator from old, fragile plumbing fixtures.
- ✓ The shower or faucet flow rate must be satisfactory to the occupants and be documented.
- ✓ Select features that meet any special needs of the occupant: swivel head, hand-held shower, for example.

- ✓ Evaluate water quality for debris that may clog the shower head or aerator.
- ✓ Use a non-hardening thread sealant when installing the device.
- ✓ Check the fixtures after installation for adequate tightness to prevent leakage at the connection.
- ✓ Recycle replaced shower heads and aerators.

**Water-saving shower heads:** Two styles of water-saving shower heads give consumers a choice between steamy showers and less steamy ones.

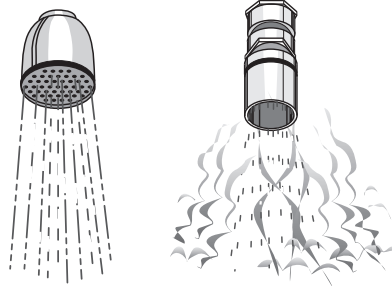

## Measuring Shower or Faucet Flow Rate

You can determine flow rate by measuring the time needed to fill a one-gallon plastic container. If the one-gallon container fills in less than 20 seconds, your flow rate is more than 3 gallons per minute.

1. Start the shower and set it to the maximum showering rate.
2. Start a stopwatch at the same time you move the container underneath the shower, capturing its entire flow.
3. Record the number of seconds and divide 60 by that number to find gallons per minute.

**Measuring shower flow rate:** If you divide 60 by the number of seconds needed to fill a gallon container, you can calculate flow in gallons per minute.

$$60 \text{ sec} \div \frac{1 \text{ gal}}{15 \text{ sec}} = 4 \frac{\text{gal}}{\text{min}}$$

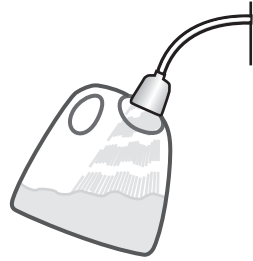

## 10.6.2 Water Heater Blankets

### *SWS Detail: 7.0301.2 Tank Insulation*

Install an R-11 insulation blanket on all water heaters **unless the manufacturer's label prohibits it**. Follow these guidelines to avoid fire hazards and to simplify future service.

#### Gas Water Heaters

When you install insulation on gas water heaters, use these specifications.

- ✓ Keep insulation at least 2 inches away from the gas valve and the burner access panel. Don't install insulation below the burner access panel.
- ✓ Don't cover the pressure relief valve or discharge line with insulation.
- ✓ Don't insulate the tops of gas-fired water heaters because the insulation can obstruct the draft diverter.
- ✓ Don't insulate Flammable Vapor Ignition Resistant (FVIR) water heaters. The blanket may shift and unintentionally cover the combustion air openings.

#### Electric Water Heaters

When you install insulation on electric water heaters, use these specifications.

- ✓ Mark the blanket to locate the thermostat and heating element access plates and cut the blanket at these locations.
- ✓ When you cut the blanket for the thermostats, cut the bottom and sides but not the top. This creates a hinge that allows the door in the insulation to swing open and closed.
- ✓ Cover the top of the water heater with insulation.
- ✓ Don't cover the pressure relief valve and discharge line with insulation.
- ✓ If you specify insulation for an existing water heater which has a relief valve but no discharge line, install a discharge line outside the insulation to within 6 inches of the floor.
- ✓ Also install 3 zip-ties over the blanket. One within 6" of the top and bottom of the tank, and one in the middle.

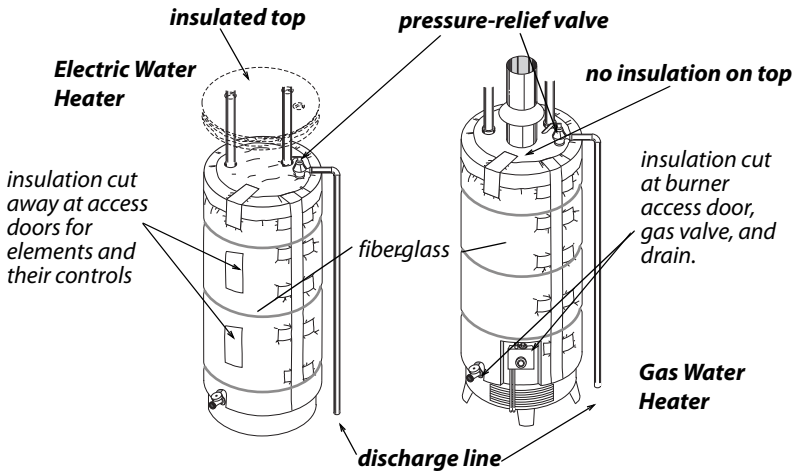

**Water heater insulation:** Insulation should be installed carefully so it doesn't interfere with the burner, elements, draft diverter, FVIR combustion intake, or pressure relief valve and discharge line.



**Video: Wrapping a Water Heater**— Wrapping a gas water heater with a fiberglass insulation blanket. Shows proper fitting and fastening procedures.

## 10.6.3 Measuring and Adjusting Hot Water Temperature

Use the following instructions to adjust water temperature.

- ✓ Shut off power to an electric water heater before opening thermostat access panels.
- ✓ Measure the water temperature at the nearest faucet to the water heater. Reduce the temperature to 120° F with the client's permission.
- ✓ On electric water heaters, set both upper and lower thermostats to the same temperature.



**Setting hot-water temperature:** Getting the temperature correct can take a few measurements and re-adjustments.

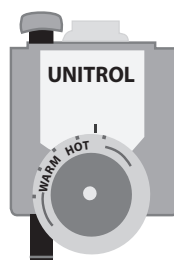

*Gas water heater control*



*Electric water heater control*

## 10.6.4 Heat Traps and Water-Heater Pipe Insulation

*SWS Detail: 7.0301 Thermal Loss Reduction; 7.0301.1 Pipe Insulation; 7.0302.1 Electric Storage Tank Water Heater; 7.0302.2 Fuel-Fired Storage Tank Water Heater; 7.0302.3 Heat Pump Storage Tank Water Heater; 7.0302.4 Non Heated Storage Tank*

Heat traps are piping loops or valves that prevent thermosiphoning of water in and out of the piping near the water

heater. Install heat traps if the water heater has no built-in heat traps.

Install pipe insulation to slow convection of hot water into the water lines near the tank.

- ✓ Interior diameter of pipe sleeve must match exterior diameter of pipe.
- ✓ Insulate the first 6 feet of hot and cold water pipe from the water heater.
- ✓ Use pipe wrap with a minimum thickness of 1 inch and a minimum R-value of 3. Cover elbows, unions and other fittings with the same insulation thickness as the pipe.
- ✓ Corners must be mitered, tight fitting, sealed and secured with appropriate material to prevent failure.
- ✓ Keep pipe insulation 6 inches away from single-wall vent pipe and 1 inch away from Type B vent.
- ✓ Fasten pipe insulation with zip ties, tape, or other approved method.

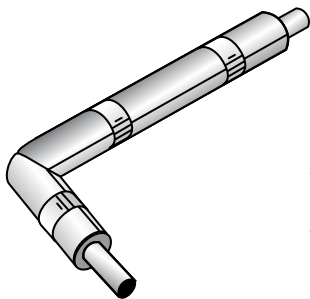

**Properly installed pipe insulation:** Must be the right size for the pipe, must completely cover the pipe, including bends, and must be fastened tightly to the pipe.

## 10.7 SELECTING STORAGE WATER HEATERS

*SWS Detail: 7.03 Water Heating*

Storage water heaters are the most common water heaters found

in homes. All ECM replacement water heaters must achieve an SIR of 1.0 or greater. *For installation instructions, see page 486.*

### 10.7.1 Determining a Storage Water Heater's Insulation Level

Common storage water heaters consist of a tank, insulation surrounding the tank, and an outer shell. There is typically either 1 or 2 inches of insulation surrounding the tank. The insulation is either fiberglass or polyisocyanurate.

Follow this procedure to determine the water heater's insulation level.

- ✓ Look for a listing of R-value on a label on the water heater.
- ✓ Find a hole in the outer shell where the flue pipe emerges or where plumbing connects. Look around the hole for either fiberglass or polyisocyanurate insulation.
- ✓ If the hole isn't large enough to see the insulation level on an electric water heater, try removing the access panel for the heating element after disconnecting power from the unit.
- ✓ You may just be able to see the gap between the tank and outer shell. If you can't see this gap, use a ruler or probe to push through the insulation along side of a pipe connecting to the tank until the probe hits the steel tank to determine thickness. Make sure that the probe is against the tank and not against a nut welded to the tank.
- ✓ If additional tank insulation is installed, it must be at least R-11. **Don't install insulation if the manufacturer's label on the water heater prohibits it.**

## Identifying Tank Insulation

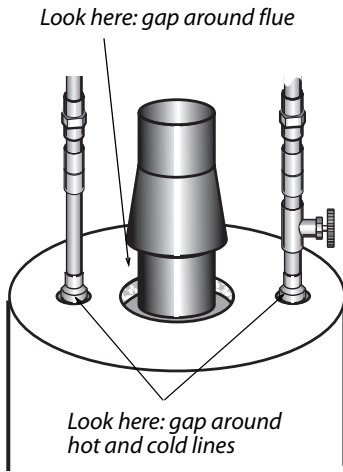

Table 10-6: Insulation R-Values

Insulation/thickness	R
Fiberglass 1 inch	3
Fiberglass 2 inches	6
PIC 1 inch	6.5
PIC 2 inches	13
PIC 3 inches	19.5

### 10.7.2 Storage Water-Heater Selection

*SWS Detail: 7.0302.1 Electric Storage Tank Water Heater; 7.0302.2 Fuel-Fired Storage Tank Water Heater; 7.0303.5 Expansion Tank (Potable Water)*

Existing gas water heaters, including propane, typically use 200 to 400 therms per year. New gas water heaters use as little as 175 therms per year, resulting in a savings of between 25 and 225 therms per year. Similar savings are possible by replacing electric water heaters. Consider the following recommendations for specifying water heaters.

- A replacement gas or oil storage water heater should have an energy factor of at least 0.67 and be insulated with at least 2 inches of foam insulation.
- A replacement electric water heater should have an energy factor of at least 0.93 and be insulated with at least 2.5 inches of foam insulation.



## 10.8 ALTERNATIVE WATER HEATERS

*SWS Detail: 7.0302 Water Heater Installation; 7.0303 Distribution Components*

Weatherization programs sometimes choose alternative water-heating products to improve efficiency and safety. *For installation instructions, see page 486.*

### 10.8.1 Sidewall-Vented Gas Storage Water Heaters

When gas storage water heaters cause persistent venting problems, specify a sidewall-venting water heater. Two common types of these water heaters are shown here.

- ✓ Choose a sealed-combustion sidewall-vented gas water heater, if possible. Next best is a fan-assisted unit.
- ✓ Install the replacement water heater in accordance with manufacturer specifications, 2012 IRC G2427.8.

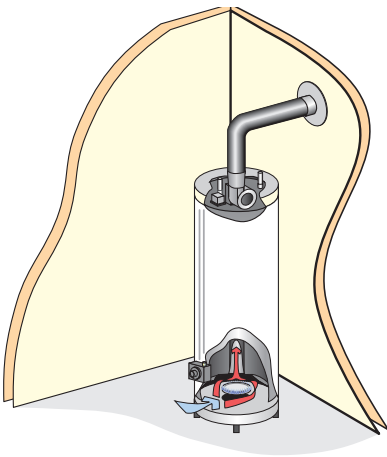

**Fan-assisted water heater:** The fan allows horizontal venting. The water heater may be open combustion or sealed combustion.

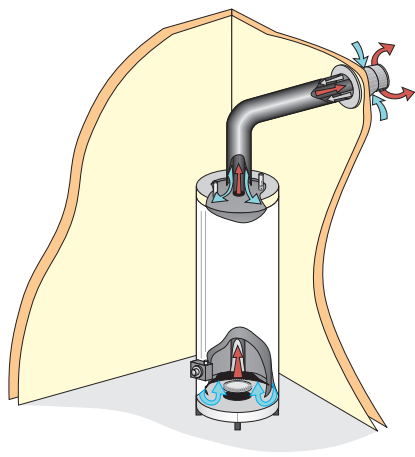

**Direct-vent water heater:** Moves combustion air and flue gases through a concentric pipe system without a draft fan.

## 10.8.2 On-Demand Gas Water Heaters

*SWS Detail: 7.0302.5 Tankless On-Demand/Point-Of-Use Appliances*

On-demand gas water heaters are more efficient and cost less to operate compared to conventional gas storage water heaters. However, on-demand gas water are more expensive to install and may have shorter lifespans compared to storage water heaters.

Choose a sealed-combustion on-demand gas water heater, if possible. A fan-assisted on-demand gas water heater is the next best choice.

## 10.8.3 Heat-Pump Water Heaters

*SWS Detail: 7.0302.3 Heat Pump Storage Tank Water Heater*

Heat pump water heaters can heat water at up to 2-3 times more efficiently than electric-resistance storage water heaters. Heat pump water heaters use heat from surrounding air to heat water. They cost much more than conventional electric water heaters but are far less costly to operate.



**Heat pump water heater:** This heat pump water heater has the heating coil (condenser) surrounded by the domestic water.

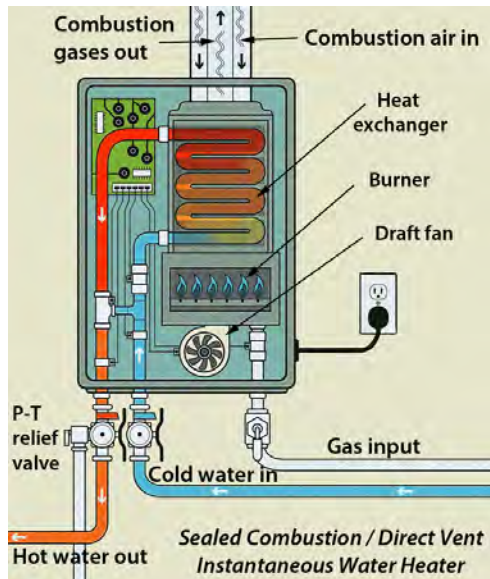

**Sealed-combustion on-demand water heater:** These water heaters have a small market share and save around one-third of energy used by the best storage water heaters.

**Table 10-7: Comparison of Advanced Water Heaters**

<b>Advanced Water Heater Type</b>	<b>\$ Savings*</b>	<b>Expected Lifespan</b>	<b>Major Advantages</b>
High-efficiency storage tank (Oil, gas, electric)	≤\$500	8–15 years	Lowest first cost
Instantaneous Tankless (direct fired)	≤\$1800	5-15 years	Unlimited hot water
Heat pump	≤\$3000	5-15 years	Most efficient electric option
From information supplied by ENERGYSTAR.gov by the Environmental Protection Agency. * Lifetime savings compared to conventional water-heater models and same fuel.			

## 10.9 WATER-HEATER INSTALLATION

*SWS Detail: 7.0302 Water Heater Installation; 7.0302.1 Electric Storage Tank Water Heater; 7.0302.2 Fuel-Fired Storage Tank Water Heater; 7.0302.3 Heat Pump Storage Tank Water Heater; 7.0302.4 Non Heated Storage Tank*

Follow these procedures when installing a storage water heater or an alternative water heater.

- ✓ A replacement water heater must have a pressure-and-temperature relief valve with a discharge line that terminates less than 6 inches from the floor into a floor drain or drain pan.
- ✓ The discharge pipe should be made of rigid metal pipe or approved high-temperature plastic pipe.
- ✓ Install dielectric unions as required and a backflow preventer as part of a water heater replacement if any of these components are missing from the existing installation.

- ✓ Install an expansion tank for all storage water-heater replacements when needed.
- ✓ If leakage would cause damage to the home, install an emergency drain pan with sides that extend a minimum of 4 inches above the floor under a replacement water.
- ✓ Install a  $\frac{3}{4}$ -inch drain line to the tapping on drain pan. Terminate the drain line in a floor drain or outdoors, at least 6 inches above grade.
- ✓ Install heat traps on the water heater's inlet and outlet piping if the manufacturer hasn't provided traps.
- ✓ Adjust water temperature to 120° F or to the lowest setting acceptable to occupants.

## 10.10 COMPARING WATER HEATERS

The choice of fuel and model for a storage water heater isn't easy and it involves many factors including safety, reliability, efficiency, and installed cost.

### 10.10.1 Safety Comparison

Conventional direct-fired gas water heaters vent their combustion by-products to a gravity vented chimney. They can spill products of combustion into the living space, especially if the chimney isn't tall enough, warm enough, or sized properly. Sharing of a main chimney with another combustion appliance can cause venting problems. If the furnace or boiler is replaced with a sealed-combustion or horizontal-vented model, the chimney may then be too big for the remaining combustion water heater.

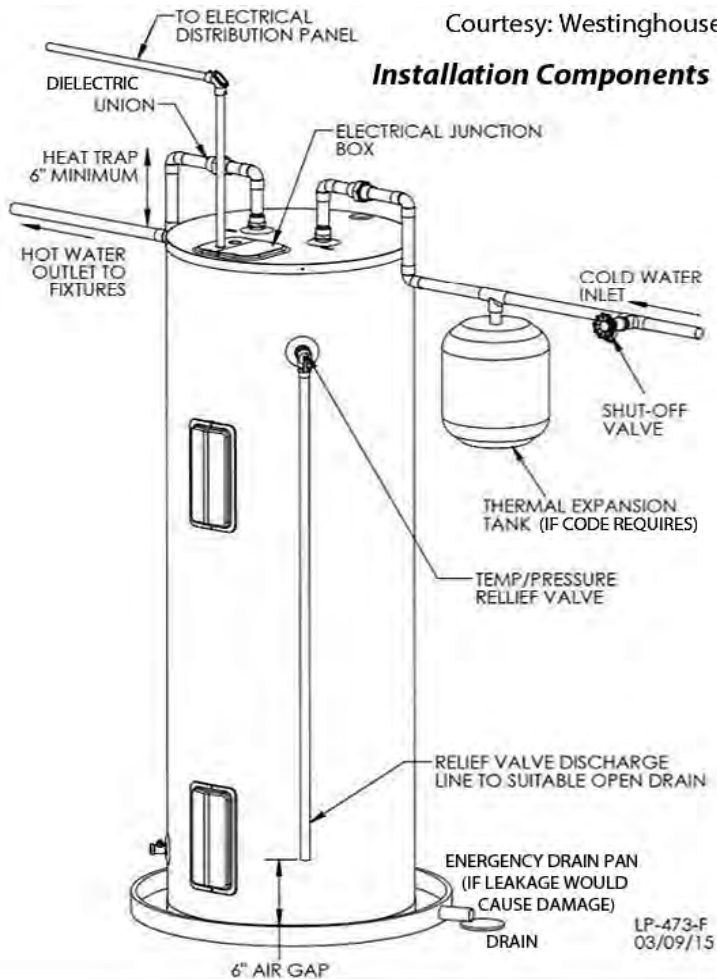

**Storage water heater installation:** The SWS requires these components on new-water-heater installations.

Electric water heaters have no chimney and need no combustion air, which makes them safer for buildings with low natural air leakage, compared to gas storage water heaters.

Electric water heaters have no products of combustion. However, because their recovery capacity is generally much slower than gas water heaters of the same size, there is a greater chance of someone trying to compensate for a cold shower by setting

the electric water heater to an unsafely high temperature where occupants could be scalded.

### 10.10.2 Reliability Comparison

Storage water heaters are popular because they are inexpensive and reliable. Both gas and electric storage water heaters are simpler and more reliable than more expensive and complex water heaters. The lifespan of storage water heaters depends on local water quality and the quality of the water heater's storage tank.

Most heaters have glass-lined steel tanks which are typically warranted for five years. All types of heaters are available with larger or additional sacrificial anodes, which are pieces of metal that corrode before the tank does, thereby extending the tank life and maybe the warranty. If you buy a ten-year guarantee heater instead of a five-year guarantee heater, this choice might reduce the future cost of replacement and possible water damage from eventual storage-tank leaks.

### 10.10.3 Efficiency and Energy Cost Comparison

Conventional gas storage water heaters are rated at about 80% steady-state efficiency. However, whenever a storage water heater isn't firing, it's losing heat up the chimney. This happens when cold air, flowing through the heater, is warmed by the heater and escapes up the flue. This off-cycle heat loss reduces annual efficiency drastically and may result in the water heater's energy factor (EF) being less than 0.60.

The exact EF for a particular storage water heater is difficult to estimate because of many factors including: chimney height, chimney diameter, wind, the home's air-tightness, outdoor temperature, and water heater temperature setpoint. Considering these variables, the actual EF can vary from 0.60 to 0.40 or even lower. Nevertheless, gas storage water heaters cost less to operate than electric water heaters with the same insulation level.

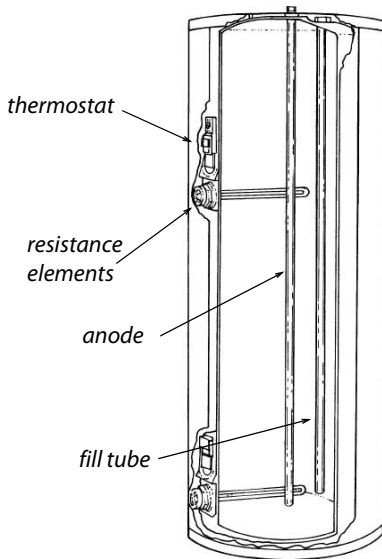

**Standard electric storage water heater:** Electric water heating is more expensive than gas or oil but safer. Electric water heaters should have at least 2 inches of foam insulation.

As a heating fuel, electricity is approximately 2.5 times as expensive as natural gas. However, electric water heaters have no chimney and therefore no chimney losses. Electric water heaters do lose heat through the insulation jacket, which results in an EF of around 0.90. Heat-pump water heaters have an operating efficiency of over 200% (COP = 2.3) because they heat water with heat from the surrounding air. But because the electricity production and transmission system in the U.S. is about 31% efficient, the overall energy use and cost for heating water with electricity is still higher than with gas.

## 10.11 MULTIFAMILY WATER HEATING

*SWS Detail: 7.0303 Distribution Components; 5.0203.1 Boilers*

Multifamily water heating is much more complex than single family water heating. Particularly in large multifamily buildings, a water heating system may deliver zero gallons to several thousand gallons of hot water an hour.



## 10.11.1 Multifamily Water-Heating Choices

*SWS Detail: 7.0302.4 Non Heated Storage Tank; 7.0302.5 Tankless On-Demand/Point-Of-Use Appliances*

To provide hot water efficiently, this huge range of demand requires a system that resupply hot water slowly to a storage tank during low demand and also provide 15 to 50 gallons per minute during high demand. A staged array of on-demand water heaters has become very popular for multifamily water heating in the past 20 years.

### Multiple Storage Water Heaters

Many multifamily buildings use multiple large size (80 gallons) storage water heaters. The lifespan of these units can be as little as 7 years. This creates an annual replacement cycle that decreases reliability and increases the per-gallon cost of hot water.

### Water Heating with a Single Boiler

Asking a single boiler to cover this range of demand requires either a modulating boiler or a huge storage tank or both to cover the range between peak usage and the minimum. The problems of providing for this demand variability with a single boiler, which may also provide space heating are these.

- A single heat exchanger can't really operate efficiently with such a wide variability of demand.
- If the boiler malfunctions, nobody has hot water.
- The mismatch between supply and demand are greater because of the boiler's responsibility for space heating.
- The control system is necessarily more complex than a simple staging control system.



**Popular multifamily water-heating solution:** On-demand water heaters heat water for a storage tank and for demand in a medium-sized multifamily building.

## Staged On-Demand Water Heaters

Multifamily-building managers are now choosing staged on-demand water heaters to solve the problems of multiple storage water heaters or a single boiler.

The control systems for these on-demand systems regulate the number of units that fire based on demand. Because of the staging, the system can provide excess capacity for reliability in the event of unit failure without an efficiency penalty. And, the control system can spread the operating time equally among the units for further reliability.

### 10.11.2 Multifamily Storage Tanks

The design and selection of a multifamily hot-water storage tanks depends on the following factors among others.

- Peak hot-water demand.
- The capacity of the water heater(s).
- The budget of the building manager.

- Space available for installation.

The tank should have these features.

- ✓ R-12.5 or greater R-value.
- ✓ Glass or plastic anti-corrosion coating.
- ✓ 20-year warranty.
- ✓ Size selection to meet available footprint in mechanical area.

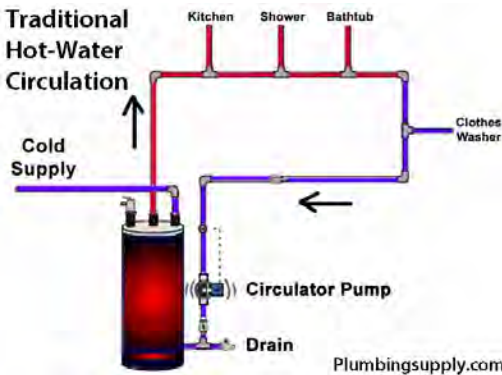

**Hot-water re-circulation:** Most multifamily hot-water circulation systems return cold water to the water heater and supply hot water to the distribution pipes.

### 10.11.3 Circulation Systems

*SWS Detail: 7.0303.6 Recirculation System Temperature Modulation Controls; 7.0301.1 Pipe Insulation*

The circulation pump moves water to provide hot water in pipes near the faucets and showers. The pump compensates for heat loss through pipes.

The pump should provide hot water to the farthest fixture from the tank at a temperature no cooler than 90°. The engineer must calculate the pipes' heat loss to size the pump correctly.

## Types of Circulation Systems

Circulation pumps move hot water through the hot-water distribution pipes to provide hot water at or near every plumbing fixture. Circulation systems reduce wasted water that drains away while occupants wait for the hot water to arrive. The pump supplies freshly heated water near the fixture to counteract the pipes' steady heat loss. Two types of circulation systems are common.

1. Circulation that uses a return pipe.
2. Circulation that doesn't use a return pipe.

The circulation system without a return pipe is called demand circulation. Demand circulation is newer and less common, requiring controls in every dwelling unit. Large single family and small multifamily buildings are the primary users.

## 10.12 SWS ALIGNMENT

<b>Field Guide Topic</b>	
10: Baseload Measures - Pg. 453	7 Baseload
10.1.1: Refrigerator Replacement - Pg. 454	7.0101.1 Refrigerator and Freezer Replacement
10.1.2: Refrigerator Cleaning and Tuning - Pg. 455	7.0101.2 Refrigerator/Freezer Clean and Tune
10.2: Electronic Entertainment and Computers - Pg. 460	7.0102 Electronics 7.0102.1 Consumer Electronics Replacement
10.3: Lighting-Efficiency Improvements - Pg. 462	7.0103 Lighting 7.0103.2 Lighting Reduction
10.3.1: LEDs versus CFLs - Pg. 462	7.0103.2 Lighting Reduction 7.0103.1 Lighting Replacement
10.3.5: Daylighting - Pg. 467	7.0103.7 Daylighting

<b>Field Guide Topic</b>	
10.3.2: Home Lighting Retrofit Equipment - Pg. 463	7.0103.2 Lighting Reduction; 7.0103.1 Lighting Replacement; 7.0103.3 Ballast Replacement; 7.0104 Lighting Controls
10.3.3: Reducing Fixture Wattage - Pg. 465	7.0103.2 Lighting Reduction; 7.0103.1 Lighting Replacement 7.0103.3 Ballast Replacement 7.0103.4 Exit Sign Replacement 7.0103.5 Emergency Lighting Replacement 7.0103.6 Security Lighting
10.4: Clothes-Washer Selection/ Replacement - Pg. 468	7.0105 Laundry
10.4.1: Clothes-Washer Selection - Pg. 468	7.0105.1 Washing Machine
10.4.2: Clothes-Washer Installation - Pg. 469	7.0105.1 Washing Machine
10.5: Clothes Dryers - Pg. 470	7.0105 Laundry
10.5.1: Clothes-Dryer Selection - Pg. 470	7.0105.2 Clothes Dryer
10.5.2: Clothes-Dryer Installation - Pg. 470	6.0202.1 Clothes Dryer 7.0105.2 Clothes Dryer
10.5.3: Clothes-Dryer Service and Venting - Pg. 471	6.0202.1 Clothes Dryer 7.0105.2 Clothes Dryer
10.6: Water-Heating Energy Savings - Pg. 474	7.02 Water Conservation 7.03 Water Heating
10.6.1: Water-Saving Shower Heads and Faucet Aerators - Pg. 475	7.0201.1 Low-Flow Devices
10.6.2: Water Heater Blankets - Pg. 477	7.0301.2 Tank Insulation

Field Guide Topic	
10.6.4: Heat Traps and Water-Heater Pipe Insulation - Pg. 479	7.0301 Thermal Loss Reduction 7.0301.1 Pipe Insulation 7.0302.1 Electric Storage Tank Water Heater 7.0302.2 Fuel-Fired Storage Tank Water Heater 7.0302.3 Heat Pump Storage Tank Water Heater 7.0302.4 Non Heated Storage Tank
10.7: Selecting Storage Water Heaters - Pg. 480	7.03 Water Heating
10.7.2: Storage Water-Heater Selection - Pg. 482	7.0302.1 Electric Storage Tank Water Heater 7.0302.2 Fuel-Fired Storage Tank Water Heater 7.0303.5 Expansion Tank (Potable Water)
10.8: Alternative Water Heaters - Pg. 483	7.0302 Water Heater Installation 7.0303 Distribution Components
10.8.2: On-Demand Gas Water Heaters - Pg. 484	7.0302.5 Tankless On-Demand/Point-Of-Use Appliances
10.8.3: Heat-Pump Water Heaters - Pg. 484	7.0302.3 Heat Pump Storage Tank Water Heater
10.9: Water-Heater Installation - Pg. 486	7.0302 Water Heater Installation 7.0302.1 Electric Storage Tank Water Heater 7.0302.2 Fuel-Fired Storage Tank Water Heater 7.0302.3 Heat Pump Storage Tank Water Heater 7.0302.4 Non Heated Storage Tank

<b>Field Guide Topic</b>	
10.11: Multifamily Water Heating - Pg. 490	7.0303 Distribution Components 5.0203.1 Boilers
10.11.1: Multifamily Water-Heating Choices - Pg. 491	7.0302.4 Non Heated Storage Tank 7.0302.5 Tankless On-Demand/Point-Of-Use Appliances





# CHAPTER 11: MOBILE HOMES

Mobile homes are covered by their own details and outcomes in the SWS, which refers to mobile homes as manufactured homes. These two names refer to the same type of housing. We prefer the term “mobile home.” In this chapter, we cover mobile-home air sealing, insulation, windows, doors, and heating systems.

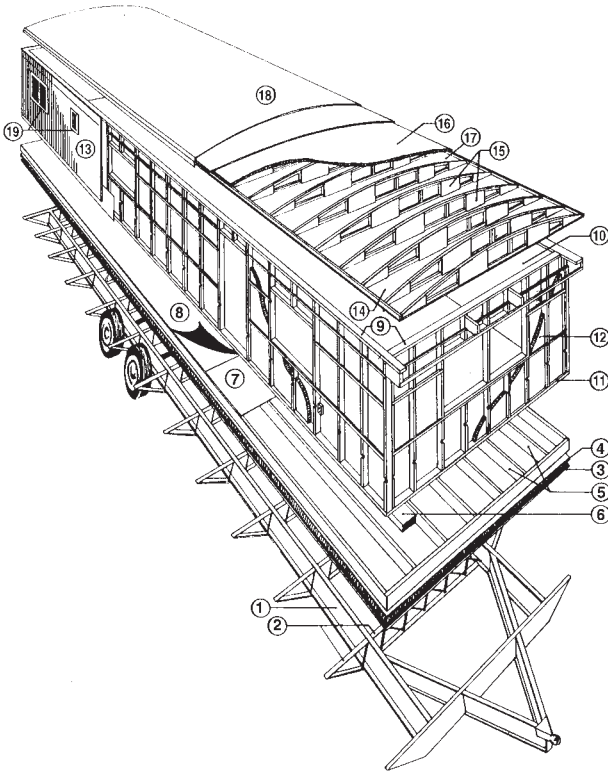

**Typical components of a mobile home:** 1–Steel chassis. 2–Steel outriggers and cross members. 3–Underbelly. 4–Fiberglass insulation. 5–Floor joists. 6–Heating/air conditioning duct. 7–Decking. 8–Floor covering. 9–Top plate. 10–Interior paneling. 11–Bottom plate. 12–Fiberglass insulation. 13–Metal siding. 14–Ceiling board. 15–BOWSTRING trusses. 16–Fiberglass insulation. 17–Vapor barrier. 18–Galvanized steel one-piece roof. 19–Metal windows.

## 11.1 MOBILE-HOME HEATING

### *SWS Detail: 5.0105 Duct Repair*

Mobile-home furnaces are similar to furnaces for site-built homes in some ways and different in other ways. Mobile-home combustion furnaces have been sealed-combustion since the early 1970s. Gas furnaces are either the old atmospheric sealed-combustion type or the newer fan-assisted mid-efficiency type. Some older less-efficient sealed-combustion furnaces had draft fans too. For information on electric furnaces, see *“Electric Furnaces” on page 391.*

Mobile-home oil furnaces are a close relative to oil furnaces in site-built homes. However, they should have a housing that fits around the burner’s air shutter and provides outdoor air directly to the burner. See *“Oil Burner Safety and Efficiency Service” on page 314.*

Mobile-home furnaces are different from conventional furnaces in the following ways.

- A great majority of mobile homes are equipped with down-flow furnaces, designed specifically for mobile homes.
- Mobile-home combustion furnaces are sealed-combustion units that use outdoor combustion air, unlike most furnaces in site-built homes. They don’t have draft diverters or barometric draft controls.
- Gas-fired furnaces have kits attached, containing alternative orifices, to burn either propane or gas.
- Return air enters the furnace through a large opening in the furnace rather than through return ducts.

**Important Note:** *The Manufactured Home Construction and Safety Standards* require all fuel-burning, heat-producing appliances in mobile homes, except ranges and ovens, to be vented to outdoors.

All fuel-burning appliances in mobile homes, except ranges, ovens, including illuminating appliances, clothes dryers, solid fuel-burning fireplaces and solid fuel-burning stoves, must be installed to provide for the complete separation of the combustion system from the interior atmosphere of the manufactured home. This means that all fuel-burning appliances must bring combustion air directly into the appliance from outdoors.

**Unvented space heaters aren't allowed in mobile homes weatherized by SC WAP.**

**Mobile-home furnace combustion:** Combustion air enters through the flue assembly on the roof and feeds the flame through a sealed passageway.

**Mobile-home furnace airflow:** Return air flows from the hallway through the furnace grill. The air is heated and distributed through the ducts.

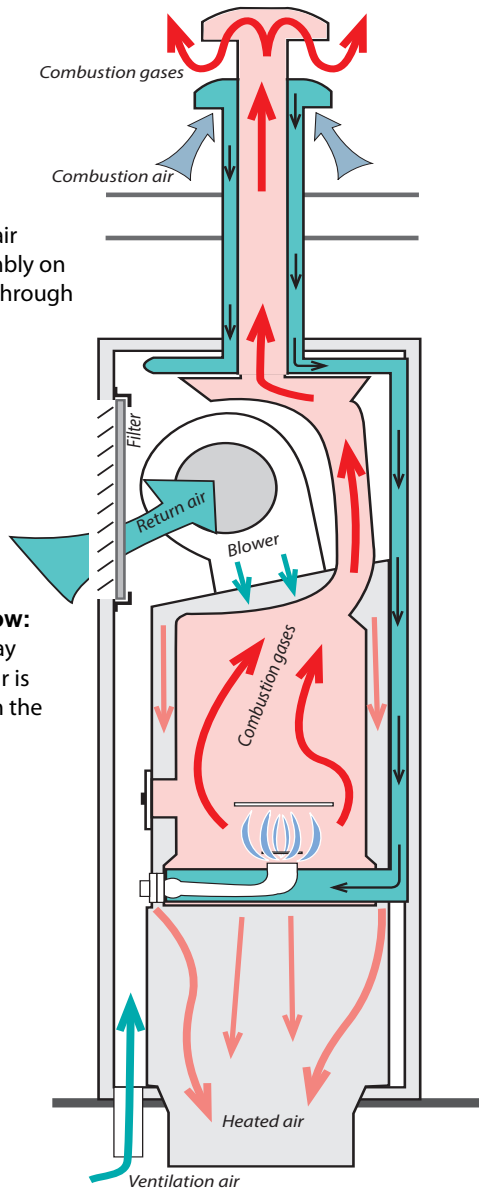

### 11.1.1 Furnace Maintenance and Energy Efficiency

Mobile-home furnaces should comply with this guidebook's combustion safety and efficiency standards. See *"Gas Burner Safety & Efficiency Service" on page 311* and *"Oil Burner Safety and Efficiency Service" on page 314*.

### 11.1.2 Furnace Replacement

Mobile-home furnaces must be replaced by furnaces designed and listed for use in mobile homes. If a heat exchanger is available to replace the existing cracked heat exchanger, consider heat-exchanger replacement as a repair priority instead of replacing the furnace.

Consider replacing the existing furnace with a sealed-combustion, downflow, condensing furnace. One manufacturer makes condensing furnaces, approved for mobile homes.

Consider replacing a mobile-home furnace when you observe any of the following.

- The furnace has a cracked heat exchanger.
- Repair and retrofit exceed half of the replacement cost.
- The furnace isn't operating and not repairable.

Mobile-home furnaces require an outdoor source of combustion air. Mobile-home furnaces have either a manufactured chimney that includes a passageway for combustion air or a combustion-air chute connecting the burner with the crawl space.

- ✓ Install a new furnace base unless you are sure that the existing base exactly matches the new furnace.
- ✓ Attach the furnace base firmly to the duct, and seal all seams between the base and duct with mastic and fabric tape before installing the furnace.
- ✓ Support the main duct underneath the furnace with additional strapping if necessary.

- ✓ When replacing mobile-home furnaces, note the differences between old furnace and new, in the way each supplies itself with combustion air.
- ✓ Install a new chimney that is manufactured specifically for the new furnace.
- ✓ Often the old chimney opening doesn't exactly line up with the new furnace's flue. In these cases either use an off-set pipe, provided by the manufacturer, or else cut the opening larger so that the new chimney can be installed absolutely vertical. Also make sure the chimney cap is installed absolutely straight.

Mobile-home furnaces have short chimneys, and their combustion process depends on a delicate balance between combustion air entering and combustion gases leaving. The furnace demands a vertical, leak-free chimney, and a properly installed chimney cap. Follow manufacturer's installation instructions exactly.

## 11.2 MOBILE-HOME COOLING AND VENTILATION SYSTEMS

*SWS Detail: 5.01 Forced Air; 5.0108 Equipment Installation*

Mobile-home cooling systems are, in most ways, identical to single-family cooling systems, which we document in [“Evaluating Ducted Central Air-Conditioning Systems” on page 399](#)

### 11.2.1 Air-Conditioning Systems

Mobile-home central air-conditioning (A/C) systems are very similar to those of single-family homes. Mobile-home split-system central A/C systems have the condenser and compressor outdoors and the air handler indoors. Packaged A/C systems have all the components in one cabinet.

Consult the following field-guide topics as necessary.

- [“Central Air-Conditioner Inspection” on page 401](#)
- [“Air-Conditioner Sizing” on page 404](#)
- [“Duct Leakage and System Airflow” on page 405](#)
- [“Evaluating Air-Conditioner Charge” on page 405](#)

## 11.2.2 Evaporative Coolers

*SWS Detail: 5.0109.5 Evaporative Coolers; 5.0108.5 Evaporative Coolers*

Evaporative coolers for mobile homes are essentially the same as those of single-family homes. [See “SWS Alignment” on page 451.](#)

## 11.2.3 Mobile-Home Ventilation

*SWS Detail: 6.03 Whole-Building Ventilation; 6.0301.1 Fresh Air Intake In Forced Air System; 6.0302.1 Individual Exhaust Fan Serving Entire Dwelling; 4.0188.2 Unconditioned Attic Ventilation*

Consult the SWS links above and the links listed below for information on mobile-home ventilation systems.

- [“Whole-Dwelling Ventilation Requirement” on page 415](#)
- [“Exhaust Ventilation” on page 430](#)
- [“Rooftop-Unit \(RTUs\) Economizer Ventilation” on page 438](#)

### Roof-and-Attic Ventilation

Consult the SWS links above and the links listed below for information on mobile-home ventilation systems.

- [See “When to Install Attic Ventilation” on page 441.](#)
- [See “Attic Ventilation as a Solution for Moisture Problems” on page 440.](#)
- [See “Attic Ventilation Requirements” on page 441.](#)

## Crawl Space Ventilation

See *“Naturally Ventilated Crawl Spaces”* on page 444.

### 11.3 MOBILE-HOME AIR SEALING

#### *SWS Detail: 3.01 General Pressure Boundary*

The location and relative importance of mobile-home air leaks was a mystery before blower doors. Some mobile homes are fairly airtight, and others are very leaky. Air leakage serves as ventilation in most mobile homes. Comply with the whole-building ventilation standards outlined in *“ASHRAE Standard 62.2–2016 Ventilation”* on page 414.

A duct airtightness tester, which pressurizes the ducts and measures their air leakage, is the best way to measure and evaluate duct air sealing. See *“Evaluating Duct Air Leakage”* on page 359. For simply locating duct leaks, the blower door used in conjunction with a pressure pan does a good job. See *“Pressure Pan Testing”* on page 361.

Most mobile-home duct sealing is performed through the belly. This work is more difficult once the belly has been re-insulated. Inspect the ductwork and seal any major leaks, such as disconnected trunk lines, before insulating the belly.



**Table 11-1: Air-Leakage Locations & Typical CFM<sub>50</sub> Reduction**

<b>Air-Sealing Procedure</b>	<b>Typical CFM<sub>50</sub> Reduction</b>
Patching large air leaks in the floor, walls and ceiling	200–900
Sealing floor cavity used as return-air plenum ( <a href="#">See “Floor return air” on page 512.</a> )	300–900
Sealing leaky water-heater closet	200–600
Sealing leaky supply ducts	100–500
Installing tight interior storm windows	100–250
Caulking and weatherstripping	50–150

Workers reduce mobile-home air leakage when they install insulation combined with proper air-sealing in roofs, walls, and belly cavities. Prioritize your efforts by performing these tasks in this order.

1. Evaluate the insulation levels. If adding insulation is cost-effective, perform the usual pre-insulation air sealing measures that also prevent spillage of insulation out of the cavity.
2. Seal ducts before you insulate the belly.
3. Install cavity insulation.
4. Re-check the air leakage rate.
5. Perform additional air sealing as needed.

## 11.3.1 Air-Leak Locations and Sealing

*SWS Detail:3.0102.5 MH Belly Repair - Soft Bottom Patching; 3.0102.6 MH Belly Repair - Soft Bottom Replacement; 3.0102.7 MH Belly Repair - Rigid Bottom Patching; 3.0102.8 MH Belly Repair - Rigid Bottom Replacement; 3.0102.9 Sealing Dropped Soffits/Bulkheads; 3.0102.10 Sealing Dropped Ceilings; 3.0102.11 Sealing Roof/Wall Connections*

### Air-Leak Locations

Blower doors have pointed out the following envelope locations as the most serious air leakage sites.

- ✓ Plumbing penetrations in floors, walls, and ceilings.  
Water-heater closets with exterior doors are particularly serious air leaks, with large openings between bathrooms and other areas
- ✓ Torn or missing underbelly, exposing air leaks in the floor to the ventilated crawl space
- ✓ Large gaps around furnace and water heater chimneys
- ✓ Severely deteriorated floors in water heater compartments
- ✓ Gaps around the electrical service panel box, light fixtures, and fans
- ✓ Interior or exterior wall sheeting materials loose or penetrated
- ✓ Joints between the halves of double-wide mobile homes and between the main dwelling and additions

### General Air-Sealing Specifications

- ✓ Select sealants that are compatible with their intended surfaces, allowing for differential expansion and contraction.
- ✓ Consider the need for ignition barriers when using significant quantities or spray foam.

- ✓ Select low volatile-organic-compound (VOC) sealants for indoor use.
- ✓ For patching, select materials that adequately support their load and function as permanent air barriers. Provide additional reinforcing materials as necessary.
- ✓ Patch fabric belly material and rigid asphalt-impregnated belly board with similar water resistive materials.

### Soft-Belly Patching and Air Sealing

Soft underbellies use a water-resistant tear-resistant fabric to function as an air barrier and protective layer for the floor cavity with crosswise floor joists. Because the duct runs lengthwise, it hangs down and the underbelly bulges at the duct.

- ✓ Span each belly section with an uninterrupted section of belly material, creating as few seams as possible.
- ✓ Lap any seams in the belly material at least 6 inches, seal with a continuous bead of sealant, and fasten mechanically every 2 inches.
- ✓ Attach fabric belly material at opposite ends of spanned section using rigid support material, such as wooden furring strips. Wrapping it around the rigid support 2 times and mechanically fastening every 6 inches.
- ✓ Attach fabric belly material to all available floor joists and reinforce the joint with rigid supports.

### Hard-Belly Patching

Hard bellies use a water-resistant rigid material such as asphalt-impregnated fiberboard. That material attaches to the floor joists of mobile homes with lengthwise floor joists. Patch the existing material with a similar material, and fasten the patch to the floor joists with mechanical fasteners.

- ✓ Remove any material from the sealing-and-patching area that could prevent full adhesion between the sealant and patch material.
- ✓ Attach continuous rigid insulation when possible to the floor joists, and install rigid supports to prevent the insulation's detachment.
- ✓ Seal joints in the rigid material and under its seams with a compatible sealant.
- ✓ Patch any hole larger than 1 square foot, by first cutting a rectangular hole in the existing material. The available floor joists should border that hole. Then mechanical fasteners attach the rectangular close-fitting patch to adjoining floor joists.
- ✓ Use mechanical fasteners with washers or integrated caps to prevent fasteners from pulling through the rigid belly material. Space the fasteners no more than 6 inches apart.

### 11.3.2 Duct-Leak Locations

*SWS Detail: 5.0105.3 Crossover Duct Repair or Replacement; 5.0105.4 Replace Return Air Systems That Use Building Cavities; 5.0105.5 Replace MH Duct Boots*

Blower doors and duct testers have pointed to the following duct locations as the most serious energy problems.

- ✓ Joints between the furnace and the main duct — if necessary, cut open the main duct from underneath to access and seal leaks between the furnace, duct connector, and main duct. With electric furnaces you access the duct connector by removing the resistance elements. For furnaces with empty A-coil compartments, you can simply remove the access panel to seal the duct connector.
- ✓ Floor cavities used as return-air plenums — These floor return systems should be eliminated and replaced with

return-air through the hall or a large grille in the furnace-closet door.

- ✓ Joints between the main duct and the short duct sections joining the main duct to a floor register
- ✓ Joints between register boots and floor
- ✓ The poorly sealed ends of the duct trunk, which often extend beyond the last supply register
- ✓ Disconnected, damaged or poorly joined crossover ducts
- ✓ Supply and return ducts for outdoor air conditioner units
- ✓ Holes cut in floors.
- ✓ New ductwork added to supply heat to room additions

Seal floor penetrations and ductwork before doing any belly repair. If you disturb pollutants in the crawl space such as mold and dust, these pollutants can spread to the whole home through duct leaks and holes in the floor.

*See “Pressure Pan Testing” on page 361. See “Sealing Supply Ducts” on page 372.*



**Video: Mobile-Home Duct Sealing**

— Proper materials and procedures for sealing ducts in mobile homes.

### 11.3.3 Belly-Pressure Test

Mobile-home supply duct leaks pressurize the belly cavity. Follow these steps to perform this rough test to determine if duct leaks are present and their general location.

- ✓ Repair the rodent barrier.
- ✓ Turn on the air handler.

- ✓ Insert a manometer hose into the belly through the rodent barrier and test the pressure with-reference-to the out-doors.
- ✓ Start near the furnace, and work your way toward the ends alongside the trunk line. A pressure rise gives you a rough idea of the location of leaks, size of leaks, and tightness of the nearby rodent barrier.
- ✓ Repair the ducts and re-test.

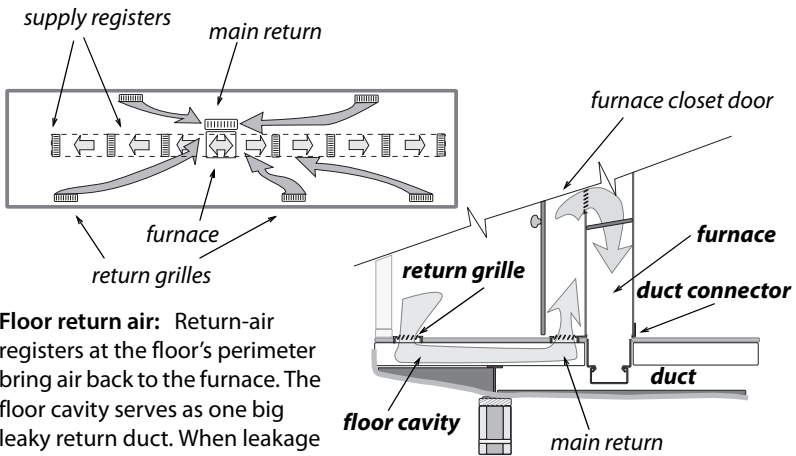

**Floor return air:** Return-air registers at the floor's perimeter bring air back to the furnace. The floor cavity serves as one big leaky return duct. When leakage is serious, the floor return system should be eliminated.

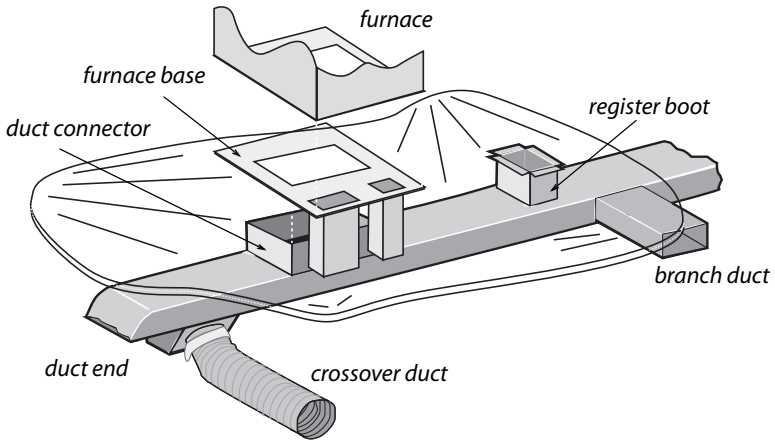

**Mobile-home ducts:** Mobile-home ducts leak at their ends and joints — especially at the joints beneath the furnace. The furnace base attaches the furnace to the duct connector. Leaks occur where the duct connector meets the main duct and where it meets the furnace. Branch ducts are rare, but easy to find, because their supply register isn't in line with the others. Crossover ducts are found only in double-wide and triple-wide homes.

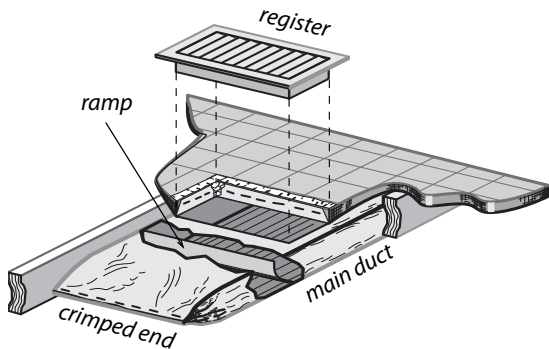

**Sealing the end of the main duct:** The main duct is usually capped or crimped loosely at each end, creating a major air leakage point. Seal this area and improve airflow by installing a sheet metal ramp, accessed through the last register, inside the duct. Seal the ramp to the ductwork with metal tape and silicone or mastic.

## 11.4 MOBILE-HOME INSULATION

*SWS Detail: 4.0103 Attic Floors - Unconditioned Attics*

Address all significant moisture problems before insulating. The most important single moisture-control measure is installing a ground-moisture barrier. *See also "Preparing for Foundation or Floor Insulation" on page 215.*

Select insulation that has a flame spread and smoke development index of 25/450 or less.

For each separate insulated building assembly, post a dated line item in a receipt signed by the installer. This posted line item must include: installed insulation type, coverage area, installed thickness, minimum settled thickness, installed R-value, and number of bags installed.

### 11.4.1 Insulating Mobile-Home Roof Cavities

*SWS Detail: 4.0103.9 MH - Blown Insulation for Flat, Bowed, or Vaulted Ceilings (via Gable End Access); 4.0103.10 MH - Blown Insulation for Flat, Bowed, or Vaulted Ceilings (via Roof Side Lift); 4.0103.11 MH - Blown Insulation for Flat, Bowed, or Vaulted Ceilings (via Roof Top Access); 4.0103.12 MH - Blown Insulation for Flat, Bowed, or Vaulted Ceilings (via Interior Access Through the Ceiling); 4.0103.13 MH - Blown Insulation in Roof-Over Construction*

Blowing a closed mobile-home roof cavity is similar to blowing a closed wall cavity, only the insulation doesn't have to be as dense. Use fiberglass blowing wool because cellulose is too heavy and absorbs water too readily for use around a mobile home's lightweight sheeting materials.

If existing insulation is attached to the underside of the roof, blow the insulation below it. If existing insulation lays on the ceiling, blow the insulation above it. If you find insulation at



both the ceiling and roof, blow the new insulation in between the two existing layers of insulation.

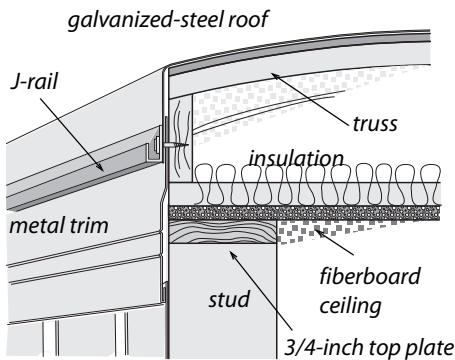

**Bowstring roof details:**

Hundreds of thousands of older mobile homes were constructed with these general construction details.

### Roof Insulation Methods

There are three common and effective methods for blowing mobile-home roof cavities.

1. Cutting a square hole in the metal roof and blowing fiberglass through a flexible fill-tube.
2. Disconnecting the metal roof at its edge and blowing fiberglass through a rigid fill-tube.
3. Blowing fiberglass through holes drilled in the ceiling.

### Existing Insulation

- If existing blanket insulation sits above the trusses, blow the new insulation below the existing blanket.
- If existing blanket insulation sits on the ceiling, blow the new insulation above the existing blanket.
- If existing blanket insulation is installed at both locations, blow the new insulation in between the two existing blankets.

### Preparation and Completion of Roof-Insulation Blowing

Perform these steps before insulating mobile-home roofs.

- ✓ Reinforce weak areas in the ceiling.
- ✓ Inspect the ceiling and seal all penetrations.
- ✓ Verify that the ceiling is intact, able to support insulation weight, and air sealed.
- ✓ Replace all broken rooftop vents, or remove them and seal the holes.
- ✓ Maintain safe clearances between insulation and recessed light fixtures and ceiling fans.
- ✓ Verify that chimneys are zero-clearance triple-wall chimneys. Otherwise maintain clearances specified by the manufacturers of non-zero-clearance chimneys. *See “Manufactured Chimneys” on page 333.*
- ✓ Select insulation that has a flame spread and smoke development index of 25/450 or less.
- ✓ Install closures/patches over all access holes that are airtight, durable, and aesthetically acceptable.
- ✓ If you removed existing trim, reinstall it to original condition.
- ✓ For accessible mobile-home attics, follow the procedures in *4.2.1: Preparing for Attic Insulation - Pg. 139.*
- ✓ Post a dated receipt signed by the installer that includes: Insulation type, coverage area, installed depth, installed R-value, and number of bags installed near the circuit-breaker box, where the home’s original specs may be posted.

### Blowing Through a Square Opening

Blowing through the roof top does a good job of filling the critical edge area with insulation, and the patches are easy to install if you have the right materials. Complete your work during good weather however, since the roof is vulnerable to rain or snow during the job. Before considering this procedure,

read “*Preparation and Completion of Roof-Insulation Blowing*” on page 515.

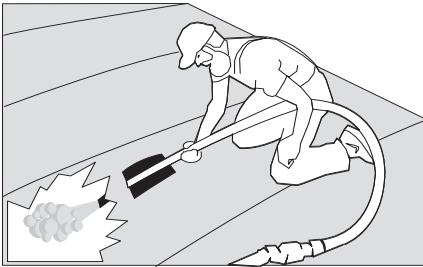

**Roof-top insulation:** Blowing fiberglass insulation through the roof top is effective at achieving good coverage and density on almost any metal roof. Use walk boards to avoid damaging the roof.

If the roof contains a strongback running the length of the roof, the holes should be centered over the strongback, which is usually near the center of the roof’s width. A strongback is a 1-by-4 or a 1-by-6, installed at a right angle to the trusses near their center point, that adds strength to the roof structure.

1. Cut 10-inch square holes at the roof’s apex on top of every second truss. Each square hole permits access to two truss cavities.
2. Use a 2-inch or 2-<sup>1</sup>/<sub>2</sub>-inch diameter fill-tube. Insert the fill-tube and push it forcefully out toward the edge of the cavity.
3. Blow fiberglass insulation into each cavity.
4. Stuff the area under each square hole with a piece of unfaced fiberglass batt so that the finished roof patch stands a little higher than the surrounding roof.
5. Patch the hole with a 14-inch-square piece of stiff galvanized steel, sealed with an appropriate sealant and screwed into the existing metal roof.
6. Cover the first patch with a second patch, consisting of an 18-inch-square piece of foil-faced butyl rubber.

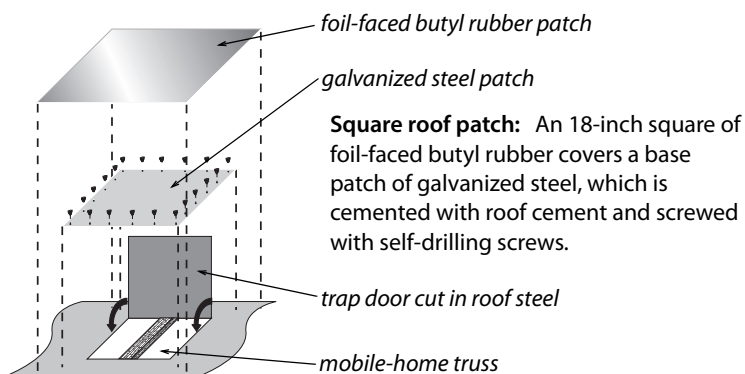

## Blowing Through a Round Hole on the Roof

Consider this alternative to cutting a square hole as suggested above. Before considering this procedure, read [“Preparation and Completion of Roof-Insulation Blowing” on page 515](#).

1. Drill a 3-inch or larger hole between each truss.
2. Use a 2-inch or 2- $\frac{1}{2}$ -inch diameter fill-tube. Insert the fill-tube, and push it forcefully out toward the edge of the cavity.
3. Blow fiberglass insulation into each cavity to fill the entire cavity.
4. Patch the holes with galvanized steel, plastic caps, and roofing material that is compatible with the existing roof.

## Blowing a Mobile-Home Roof from the Edge

Erect scaffold to do this procedure safely and efficiently. Mobile-home metal roofs are usually fastened only at the edge, where the roof joins the wall. Before considering this procedure, read [“Preparation and Completion of Roof-Insulation Blowing” on page 515](#).

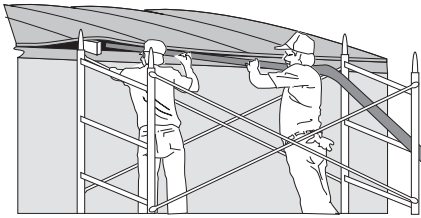

**Roof-edge blowing:** Use a rigid fill tube to blow insulation through the roof edge. This avoids making holes in the roof itself, though this process requires much care in refastening the roof edge.

1. Remove the screws from the metal j-rail at the roof edge. Also remove staples or other fasteners, and scrape off putty tape.
2. Pry the metal roof up far enough to insert a 2-inch-diameter, 10- to 14-foot-long rigid fill-tube. Two common choices are steel muffler pipe and aluminum irrigation pipe. Inspect the cavity with a bright light to identify any wires or piping that could be damaged by the fill tube.
3. Blow insulation through the fill-tube into the cavity. Turn off the insulation-material feed on the blowing machine when the tube is a couple feet from the roof edge, in order to avoid blowing insulation out through the opening in the roof edge. Stuff the last foot or two with unfaced fiberglass batts.
4. Fasten the roof edge back to the wall using galvanized roofing nails, a new metal j-rail, new putty tape, and larger screws. The ideal way to re-fasten the metal roof edge is with air-driven galvanized staples, which is the way most roof edges were attached originally.

The re-installation of the roof edge is the most important part of this procedure. You must replace the putty tape and re-install the roof edge as it was originally. This usually involves installing a layer of putty tape or a bead of high quality caulk under the metal roof and another between the metal roof edge and the j-rail.

The advantages of blowing through the edge is that if you have the right tools, including a powered stapler, this method can be very fast and doesn't require cutting into the roof. The disadvantages of this procedure are that you need scaffolding to work at the edges, and it won't work on roof systems with a central strongback that stops the fill tube from reaching all the way across the roof.

### Blowing a Mobile-Home Roof from Indoors

The advantage to this method is that you are indoors, out of the weather. The disadvantages include being indoors where you can make a mess — or worse, damage something.

Blowing the roof cavity from indoors requires drilling straight rows of 3-inch or 4-inch holes and blowing insulation into the roof cavity through a fill tube. Before considering this procedure, read *“Preparation and Completion of Roof-Insulation Blowing” on page 515.*

Follow this procedure.

1. Setup a dust-control enclosure for all interior access locations that limits insulation and construction dust.
2. Drill a 3-inch or 4-inch hole in an unseen location to discover whether the roof structure contains a strongback that would prevent blowing the roof cavity from a single row of holes.
3. Devise a way to drill a straight row of holes down the center of the ceiling. If a strongback exists, drill two rows of holes at the quarter points of the width of the ceiling.
4. If a longitudinal ceiling trim piece exists, remove trim piece and drill behind the trim.
5. Insert a flexible plastic fill tube into the cavity, and push it as far as possible toward the edge of the roof.
6. Fill the cavity with tightly packed fiberglass insulation.

7. Cap the holes with manufactured plastic caps and caulk the caps. Be careful not to damage the holes so that the plastic hole covers fit properly. You can also install a piece of painted wood trim over the line of holes.



**Blowing through the ceiling:** The contractor pushes the fill-tube into the cavity and out near the edge of the roof. The holes are drilled in a straight line for appearance sake.



**Video: Roof Cavity Insulation**— E\$P shows several ways of insulating mobile-home roof cavities.

## 11.4.2 Mobile-Home Sidewall Insulation

*SWS Details: 4.0202.3 MH - Fiberglass Batts; 4.0202.4 MH - Blown Fiberglass; 4.0202.5 MH - Blown Fiberglass Through Penetrations*

The sidewalls of many mobile homes aren't completely filled with insulation. This reduces the nominal R-value of the existing wall insulation because of convection currents and air leakage. Consider the following steps for adding insulation to partially filled mobile-home walls.

## Sidewall-Insulation Preparation

See *“Fiberglass Batts and Blankets”* on page 107.

1. Select fiberglass insulation that has a flame spread and smoke development index of 25/450 or less.
2. Check the interior paneling and trim to make sure they are securely fastened to the wall. Remove objects from the interior surfaces of the walls being insulated. Repair holes in interior paneling and caulk cracks at seams to prevent indoor air from entering the wall.
3. Note the location of electrical boxes, wire, to avoid contacting them when you push the fill tube up the wall. Don't insulate next to heat-producing devices like wall heaters.
4. Remove the bottom horizontal row of screws from the exterior siding. If the vertical joints in the siding interlock, fasten the bottom of the joints together with  $\frac{1}{2}$ -inch sheet metal screws to prevent the joints from coming apart. Pull the siding and existing insulation away from the studs, and insert the fill tube into the cavity with the point of its tip against the interior paneling.
5. With 4-by-8 wood siding, drill holes in the exterior siding around the perimeter of the home, parallel to the bottom plate an equal distance apart. Locate the holes under the lowest window sill.
6. For vinyl or metal lap siding, remove a piece of siding near the bottom of the wall. Carefully drill or cut holes in the sheathing to access the cavity.





**Batt-stuffing walls:** Installers use a flexible plastic plank to stuff a fiberglass batt into an empty or partially filled wall cavity. Installers remove screws from the bottom of the siding. Joints between sheets usually remain locked together during batt-stuffing.

## Stuffing Fiberglass Batts into Wall Cavities

Batt stuffing can be a fast and efficient wall-insulation method for older homes with metal siding. Stuffing won't work on every home or in every stud cavity, so you must blow insulation into those un-stuffable wall cavities.

Most batt stuffers are made of clear polycarbonate plastic. Insulators often bend the top of the plastic sheet to make the batt travel better up the wall.

1. Remove the bottom row of screws from the metal siding. If necessary, remove the screws from that attach the siding to the bottom-most belt rail. This can create additional room to stuff the batt if needed.
2. Drive a self-drilling sheet-metal screw into the bottom of each vertical siding joint to prevent these clinched

joints from separating during the batt-stuffing process. The joints can be difficult to rejoin.

3. Lay a batt on the ground, and place the batt stuffer on top of the batt. Allow the batt to overhang the stuffer, and fold the batt over the stuffer approximately one foot or less.
4. Clamp the batt to the batt stuffer with your gloved hand and place the stuffer and the batt into the bottom of the stud cavity. The batt stuffer hangs out the bottom of the wall.
5. Use one hand to push from the batt stuffer's bottom and the other hand to hold the batt and stuffer steady as it moves up the wall to the top plate.
6. Remove the batt stuffer and force the extra batt into the bottom of the cavity or cut it off.
7. Refasten the siding, using thicker or longer screws if necessary.



**Video: Retrofitting Batt Insulation in a Mobile-Home Sidewall**— A weatherization crew shows some methods to retrofit insulation batts in a mobile home.

## Blowing Fiberglass into Walls

Follow these procedures to blow insulation into the cavities.

1. Push the a flexible fill tube up into the wall cavity until it hits the top plate of the wall. The tube should go in to the wall cavity 7-to-8 feet. Insert the tube so that its natural curvature presses its tip against the interior paneling. When you press the angled tip of the fill tube against the smooth paneling, it is unlikely to snag the existing insulation on its way up the wall. If the fill tube hits a belt rail or other obstruction, twisting the tube helps its tip move past the obstruction.

2. Stuff a piece of fiberglass batt into the bottom of the wall cavity around the tube to prevent insulation from blowing out of the wall cavity. Leave the batt in-place at the bottom of the wall, when you pull the fill tube out of the cavity. This piece of batt acts first as temporary gasket for the hose, and second to insulate the very bottom of the cavity after you remove the hose. This batt also eliminates the need to blow fiberglass insulation all the way to the cavity's bottom, preventing possible spillage and overfilling. If you happen to overfill the bottom of the cavity, reach up inside the wall to pack or remove some fiberglass insulation, particularly any that lies between loose siding and studs.
3. Pull the tube down and out of the cavity about 6 inches at a time. Listen for the blower fan to indicate strain from back-pressure in the wall. Watch for the fiberglass insulation to slow its flow rate through the blower hose at the same time. Also watch for slight bulging of the exterior siding. These signs tell the installer when to pull the tube down.
4. Carefully refasten the siding using the same holes. Select screws that are slightly longer and thicker than the original screws. Repair sheathing, if present and if damaged, with similar material and compatible sealant.



**Video: Denspack Mobile-Home Sidewall**

— A weatherization crew shows how they denspack a mobile-home wall from the exterior.

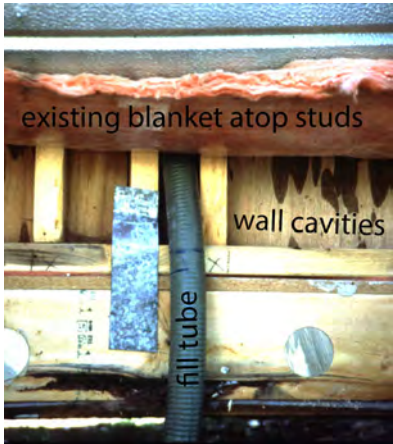

**Adding insulation to mobile-home walls:** A contractor uses a fill tube to install more insulation in a partially insulated mobile-home wall.

### 11.4.3 Mobile-Home Floor Insulation

*SWS Details: 4.0302.9 MH - Blown Belly Insulation; 4.0301 Accessible Floors; 4.0302 Exposed Floors; 4.0301.1 Batt Insulation in Joisted Cavities; 4.0301.2 Loose Fill With Netting/Fabric in Joisted Cavities; 4.0301.3 Loose Fill in Joisted Cavities With Rigid Barrier*

Mobile-home floor insulation is a good energy-saving measure in cool climates. The existing insulation usually fastens to the bottom of the floor joists, leaving much of the cavity uninsulated and subject to air convection. This greatly reduces the insulation's R-value. Blown-in belly insulation also tends to reduce duct leakage.

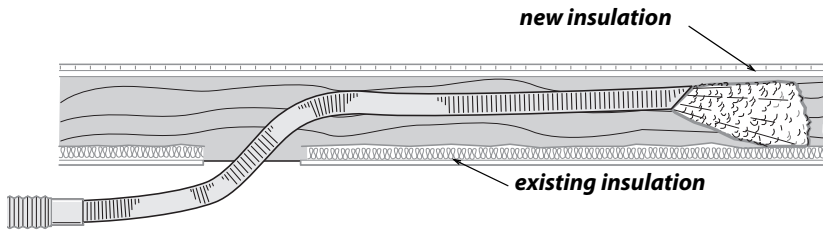

**Blowing bellies:** A flexible fill-tube, which is significantly stiffer than the blower hose, blows fiberglass insulation through a hole in the belly from underneath the home.

## Preparing for Mobile-Home Floor Insulation

Before installing floor insulation, inspect the floor and do these repairs.

- ✓ Repair plumbing leaks.
- ✓ Seal all holes in the floor.
- ✓ Inspect and seal ducts.
- ✓ Repair the underbelly for both airtightness and support of insulation. See [“Soft-Belly Patching and Air Sealing” on page 509](#) and [“Hard-Belly Patching” on page 509](#) for details.
- ✓ Install a 6-mil ground-moisture barrier in the crawl space.
- ✓ Verify that gas, water, and electrical lines are secured at least every 4 feet to a floor joist or framing member.
- ✓ Identify any plumbing lines, and avoid installing insulation between them and the living space if freezing could be an issue. This may require running a piece of belly-paper under the pipes, and insulating the resulting cavity. This cavity bundles the pipes into the dwelling’s heated envelope.
- ✓ Select insulation that has a flame spread and smoke development index of 25/450 or less.



**Video: Belly repair for insulation**— How to repair, air seal, and insulate mobile-home belly pans.



**Patching a flexible belly:** The technician uses both adhesive and stitch staples to fasten a patch.

**Blowing a floor through the belly:** The contractor inserts a rigid fill tube through the belly to blow insulation into the floor cavity and underbelly.



## Blowing Insulation into Floors

Two methods of blowing insulation into mobile-home floors are common. Blown fiberglass is recommended over cellulose for either method.

1. Drilling through the 2-by-6 rim joist and blowing fiberglass through a rigid fill tube into the belly.
2. Blowing fiberglass insulation through a flexible fill tube or a rigid fill tube into the floor cavity through the underbelly.

When blowing through holes from underneath the home, consider blowing through the underbelly's damaged areas before patching them. After blowing insulation, patch all pre-existing holes and access holes in the belly. *See "Air-Leak Locations and Sealing" on page 508.*

## Installing Fiberglass Batts in Floors

Unfaced fiberglass batts may also be used to insulate floor sections where the insulation and under belly are missing. This is a good approach when it isn't cost-effective to insulate the entire belly.

Secure batts using fasteners and structural supports that don't over-compress the insulation and that have a minimum service life of 20 years — strapping, netting, wood lath, for example.

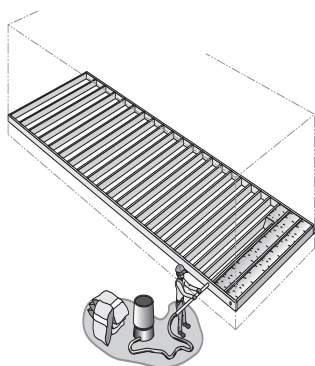

### **Blowing crosswise cavities:**

Blowing insulation into belly is easy if the floor joists run crosswise. However, the dropped belly requires more insulation than a home with lengthwise joists.

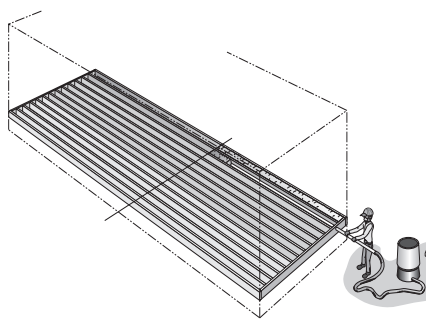

### **Blowing lengthwise cavities:**

Floors with lengthwise joists can rarely be filled completely from the ends because of the long tubing needed. The middle can be filled from underneath.

## 11.5 MOBILE-HOME WINDOWS AND DOORS

*SWS Details: 3.0201 Windows; 3.0202 Doors*

Repairing or replacing windows and doors is often part of a mobile-home weatherization job. Installing storm windows or replacing existing windows is expensive per square foot and isn't as cost-effective as insulation. However, storm windows and replacement windows are all energy conservation measures for mobile homes that are worth considering.

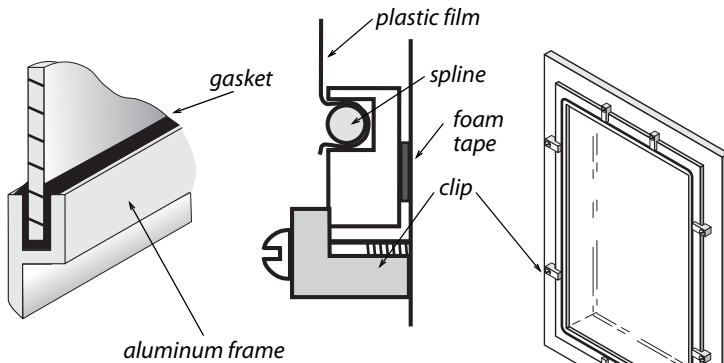

**Glass interior storms:**  
Traditional mobile-home storm windows have aluminum frames glazed with glass.

**Plastic storms:** Some newer Storm window designs use a lightweight aluminum frame and flexible or rigid plastic glazing.

## 11.5.1 Mobile-Home Storm Windows

Interior storm windows are common in mobile homes. These stationary interior storms serve awning and jalousie windows. Sliding interior storm windows pair with exterior sliding prime windows.

- ✓ Interior storm windows double the R-value of a single-pane window. They also reduce infiltration, especially in the case of leaky jalousie prime windows.
- ✓ Interior storm windows must be operable and egress-rated in egress locations. *See “Fire Egress Windows” on page 251.*
- ✓ Consider repairing existing storm windows rather than replacing them unless the existing storm windows can’t be re-glazed or repaired.
- ✓ When sliding primary windows are installed, use a sliding storm window that slides from the same side as the primary window. Sliding storm windows stay in place and aren’t removed seasonally, and are therefore less likely to be lost or broken.



- ✓ Interior storm windows must be operable and egress rated in egress locations.

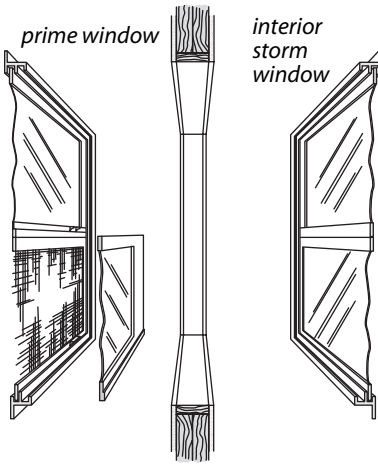

**Mobile-home double window:** In mobile homes, the prime window is installed over the siding outdoors, and the storm window is installed indoors.

## 11.5.2 Replacing Mobile-Home Windows

Replacement windows should have lower U-factors than the windows they are replacing. Inspect condition of rough opening members before replacing windows. Replace deteriorated, weak, or waterlogged framing members.

Prepare the replacement window by lining the perimeter of the inner lip with  $\frac{1}{8}$ -inch thick putty tape. Caulk exterior window frame perimeter to wall after installing the window.

## 11.5.3 Mobile-Home Doors

### *SWS Details: 3.0202 Doors*

Mobile-home doors come in two basic types: the mobile home door and the house-type door. Mobile-home doors swing outwardly, and house-type doors swing inwardly. House-type doors are available with pre-hung storm doors included.

Existing or replacement mobile-home doors should be air-tight, water-tight, and easy to operate.

- ✓ Replace missing or damaged weatherstripping, drip cap, or flashing to ensure that water or air can't penetrate the opening.
- ✓ Properly adjust the door so that it closes securely, but doesn't crush or deform its weatherstripping.
- ✓ *See also "Door Repair and Weatherstrip" on page 254.*
- ✓ *See also "Replacement-Door Installation" on page 264.*

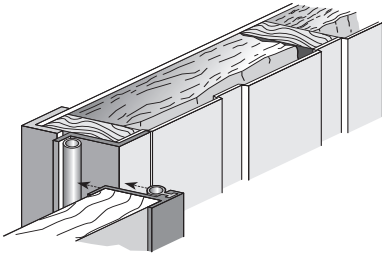

**Mobile-home door:** Mobile home doors swing outwardly and have integral weatherstrip.

## 11.6 COOL ROOFS FOR MOBILE HOMES

### *SWS Details: 5.0402.1 Reflective Roof Coatings*

Cool-roof coatings reduce summer cooling costs 10-20%, and improve comfort. They are a good choice for mobile homes with low slope roofs. *See also "Cool Roofs" on page 164.*

Cool-roof coatings are usually bright white, and must have a reflectivity of at least 60% to meet the ENERGY STAR standard. Cool roof coatings are usually water-based acrylic elastomers, and are applied with a roller or brush on a pole.

Cool-roof coatings can coat most low-sloped roofing such as metal, built-up asphalt, bitumen, or single ply membranes. Some existing roof materials require a primer to achieve acceptable adhesion — check the manufacturer's recommendations.

## Cool-Roof Installation Specifications

- ✓ Buy the highest quality coatings, and look for those that are specifically formulated as mobile-home roof coatings.
- ✓ Coatings carry ENERGY STAR labeling.
- ✓ Coatings are durable, flexible, reflective, and list in their specifications: ASTM D412, ASTM D1737, and UL 790 Class A or LEED New Construction Reflective Roof standard.
- ✓ Verify roof is clean, dry, and structurally sound
- ✓ Apply roof-coating in accordance with manufacturer specifications, including a primer if recommended.

### 11.6.1 Coating the Roof

Surface preparation is critical when applying any coating. The underlying roofing materials must be clean so the coating sticks. Do repairs if the existing roofing is cracked or blistered. Roof coating won't stick to dirty or greasy surfaces. Observe the following specifications when installing cool roof coatings.

#### Prepare the Roof

- ✓ Make roof repairs and seal all penetrations before application.
- ✓ Strip roof of debris, algae, and loose coatings.
- ✓ Pressure-wash the roof or scrub the roof with a water/trisodium phosphate (tsp) solution.
- ✓ For metal roofs, sand badly rusted areas down to bare metal. Install metal patches over any areas that are rusted through, followed by polyester-reinforced patches.
- ✓ Protect any nearby windows, siding, or trim from splatters. For spray applications, mask adjoining areas where overspray is possible, and move vehicles away from the home.

## Install the Roof Coating

- ✓ For patching, use the thicker patch coat material compatible with cool-roof coating, if available.
- ✓ Reinforce joints around skylights, pipe flashing, roof drains, wall transitions, or HVAC equipment. Use polyester fabric and roof-repair coating for these reinforcements by laying dry fabric into a layer of wet coating. Smooth the patches down with a squeegee or brush to remove bubbles or wrinkles. Allow repairs to cure for at least one day before applying the topcoats.
- ✓ Install the coating in dry weather. If rain, heavy dew, or freezing weather happens within 24 hours of installation, this weakens the coating's bond to the roof.
- ✓ For roller application, use a large brush for the edges, and a shaggy 1 to 1 1/2-inch roller on a pole. Coat the lower parts of roof jacks and other penetrations.
- ✓ Install at least two coats, with second coat applied in the opposite direction to the first to get more complete coverage. Allow a day for drying between coats.

## 11.7 MOBILE-HOME SKIRTING

*SWS Detail: 4.0388.1 Foundation Skirting; 2.0202.3 Pier and Skirting Foundations - Ground Cover*

The primary purpose of skirting is to shelter the crawl space, keep animals out, and prevent weather from damaging the dwelling. Skirting must be vented to reduce moisture accumulation in many climates, so there may not be much value in insulating it.

Installation and repair of mobile-home skirting is seldom cost-effective and may not be allowed in WAP budgets.

Comply with these SWS specifications if you repair or install skirting.

## Preparation for Skirting

- ✓ Remove debris and vegetation from the home's perimeter and level the ground.
- ✓ Select materials that compatible with existing surfaces, as well as corrosion-, pest-, and rot-resistant.
- ✓ Select materials that can contact the ground without deteriorating.
- ✓ Install a ground-moisture barrier to prevent excessive moisture as specified in "[Ground-Moisture Barriers](#)" on [page 44](#).
- ✓ Verify that installation area is free of active water leaks, fuel leaks, and pest infestations.
- ✓ Verify that installation area is free of uncovered electrical junctions, and improperly terminated devices: ventilation fans, dryers, plumbing stacks, condensate lines.

## Skirting Installation

- ✓ Install supports to prevent failure under wind or snow loads but that allow for expansion, contraction, and frost heaving.
- ✓ Fasten skirting to comply with manufacturer's specifications, using corrosion resistant fasteners.
- ✓ Install flashing that directs water away from the dwelling and the skirting if necessary.
- ✓ Seal flashing to the dwelling with compatible sealant.
- ✓ Seal all seams, joints, connections, penetrations in the skirting with compatible materials: caulking, metal mesh, steel wool, for example.

**Note:** If you plan to install insulated skirting, read carefully the SWS standards at the beginning of this section.

## 11.8 SWS ALIGNMENT

<b>Field Guide Topic</b>	<b>SWS Detail</b>
11.1: Mobile-Home Heating - Pg. 500	5.0105 Duct Repair
11.2: Mobile-Home Cooling and Ventilation Systems - Pg. 504	5.01 Forced Air 5.0108 Equipment Installation
11.2.2: Evaporative Coolers - Pg. 505	5.0109.5 Evaporative Coolers 5.0108.5 Evaporative Coolers
11.2.3: Mobile-Home Ventilation - Pg. 505	6.03 Whole-Building Ventilation 6.0301.1 Fresh Air Intake In Forced Air System 6.0302.1 Individual Exhaust Fan Serving Entire Dwelling 4.0188.2 Unconditioned Attic Ventilation
11.3: Mobile-Home Air Sealing - Pg. 506	3.01 General Pressure Boundary
11.3.1: Air-Leak Locations and Sealing - Pg. 508	3.0102.5 MH Belly Repair - Soft Bottom Patching 3.0102.6 MH Belly Repair - Soft Bottom Replacement 3.0102.7 MH Belly Repair - Rigid Bottom Patching 3.0102.8 MH Belly Repair - Rigid Bottom Replacement 3.0102.9 Sealing Dropped Soffits/Bulkheads 3.0102.10 Sealing Dropped Ceilings 3.0102.11 Sealing Roof/Wall Connections

<b>Field Guide Topic</b>	<b>SWS Detail</b>
11.3.2: Duct-Leak Locations - Pg. 510	5.0105.3 Crossover Duct Repair or Replacement 5.0105.4 Replace Return Air Systems That Use Building Cavities 5.0105.5 Replace MH Duct Boots
11.4: Mobile-Home Insulation - Pg. 514	4.0103 Attic Floors - Unconditioned Attics
11.4.1: Insulating Mobile-Home Roof Cavities - Pg. 514	4.0103.9 MH - Blown Insulation for Flat, Bowed, or Vaulted Ceilings (via Gable End Access) 4.0103.10 MH - Blown Insulation for Flat, Bowed, or Vaulted Ceilings (via Roof Side Lift) 4.0103.11 MH - Blown Insulation for Flat, Bowed, or Vaulted Ceilings (via Roof Top Access) 4.0103.12 MH - Blown Insulation for Flat, Bowed, or Vaulted Ceilings (via Interior Access Through the Ceiling) 4.0103.13 MH - Blown Insulation in Roof-Over Construction
11.4.2: Mobile-Home Sidewall Insulation - Pg. 521	4.0202.3 MH - Fiberglass Batts 4.0202.4 MH - Blown Fiberglass 4.0202.5 MH - Blown Fiberglass Through Penetrations
11.4.3: Mobile-Home Floor Insulation - Pg. 526	4.0302.9 MH - Blown Belly Insulation 4.0301 Accessible Floors 4.0302 Exposed Floors 4.0301.1 Batt Insulation in Joisted Cavities 4.0301.2 Loose Fill With Netting/Fabric in Joisted Cavities 4.0301.3 Loose Fill in Joisted Cavities With Rigid Barrier

<b>Field Guide Topic</b>	<b>SWS Detail</b>
11.5: Mobile-Home Windows and Doors - Pg. 529	3.0201 Windows 3.0202 Doors
11.5.3: Mobile-Home Doors - Pg. 531	3.0202 Doors
11.6: Cool Roofs for Mobile Homes - Pg. 532	5.0402.1 Reflective Roof Coatings
11.7: Mobile-Home Skirting - Pg. 534	4.0388.1 Foundation Skirting 2.0202.3 Pier and Skirting Foundations - Ground Cover



## CHAPTER 12: AIR LEAKAGE DIAGNOSTICS

This chapter focuses on pressure-testing homes, to determine their airtightness and to guide air-sealing during weatherization. Ideally the air barrier and insulation are installed together at the building's thermal boundary. The airtightness of the air barrier has a substantial effect on comfort, energy efficiency, and performance of the insulation. The testing described here helps to analyze the existing air barriers and decide whether and where air-sealing is needed.

### 12.1 SHELL AIR-LEAKAGE FUNDAMENTALS

Controlling air leakage is a key concern for successful weatherization. The decisions you make about sealing air leaks affect a building throughout its lifespan. Air leakage has these impacts.

- Air leakage accounts for a significant percentage of a building's heat loss.
- Air leakage through insulated assemblies reduces the R-value of insulation.
- Air leakage moves moisture in and out of the house, wetting and/or drying the building.
- Air leakage causes house pressures that can interfere with the venting of combustion appliances.

#### Air Leakage and Ventilation

Most homes depend on air leakage to provide outdoor air for diluting pollutants and admitting fresh air. However, air leaks can also bring pollutants into the home. Mechanical ventilation is a more reliable and efficient way to provide fresh air. See *“ASHRAE Standard 62.2–2016 Ventilation” on page 414.*

## 12.1.1 Goals of Air-Leakage Testing

Air-leakage testing accomplishes a variety of purposes.

- Air-leakage and pressure testing measures the home's air-tightness level.
- It evaluates the home's ventilation requirements.
- It helps you to decide how much time and effort is required to achieve cost-effective air-leakage and duct-leakage reductions.
- It helps to compare the air-tightness of the air barriers on either side of an intermediate zone, such as an attic or crawl space. For example, comparing the airtightness of the plaster ceiling with that of the ventilated sloped roof gives the auditor an idea of how leaky the ceiling is.
- It helps decide the best place to establish the air barrier in an area that has no obvious thermal boundary such as an uninsulated crawl space.

The reason for the complexity of air-leakage testing is that there is so much uncertainty about air leakage. Testing is needed because there simply is no accurate prescriptive method for determining the severity and location of leaks, especially in complex homes. Depending on the complexity of a home, you may need to perform varying levels of testing to evaluate air leakage. In particular, the number of major components like stories, additions, corners, and gables indicates a home's potential for large air-leakage reductions.



### **Video: Why measure building air leakage?**

— A perspective on building air leakage testing, using blower doors, and why do we measure air leakage anyway?

*Where is the primary air barrier:  
at the rafter or ceiling joist?*

*Are the intermediate  
zones connected?*

*Are the floor cavities  
connected to  
outdoors?*

*Do ducts supply  
heated air to the  
addition?*

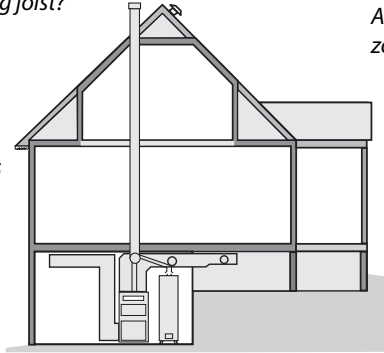

*Is the half-basement inside or outside the air  
barrier? Is this space heated?*

*Are the crawl space ducts inside or  
outside the air barrier?*

**Questions to ask during an air-leakage evaluation:** Your answers help determine the most efficient and cost-effective location for the air barrier.

## Air Sealing with Air-Leakage Testing

Dedicate most of your effort to seal the large air leaks that pass directly through the thermal boundary first. Chasing small leaks or leaks that connect to the outdoors through interior walls or floors isn't worth as much effort if the budget is limited.

- ✓ Perform blower-door testing.
- ✓ Analyze the test results to determine if air sealing is cost-effective.
- ✓ Locate and seal the air leaks.
- ✓ During air-sealing, monitor your progress with blower-door testing.
- ✓ Stop air sealing when air-sealing goals have been achieved or the budget limit has been reached.

## 12.2 SINGLE-FAMILY AIRTIGHTNESS TESTING

House airtightness testing was made possible by the development of the blower door. The blower door measures a home's leakage rate at a standard pressure of 50 pascals. Energy auditors use this leakage measurement to compare homes with one another and to established air-leakage standards.

The blower door also allows the auditor to test parts of the home's air barrier to locate air leaks. Sometimes air leaks are obvious. More often, the leaks are hidden, and you need a blower door to find their location.

This section outlines the basics of blower-door measurement along with some techniques for gathering clues about the location of air leaks.

### Blower-Door Components

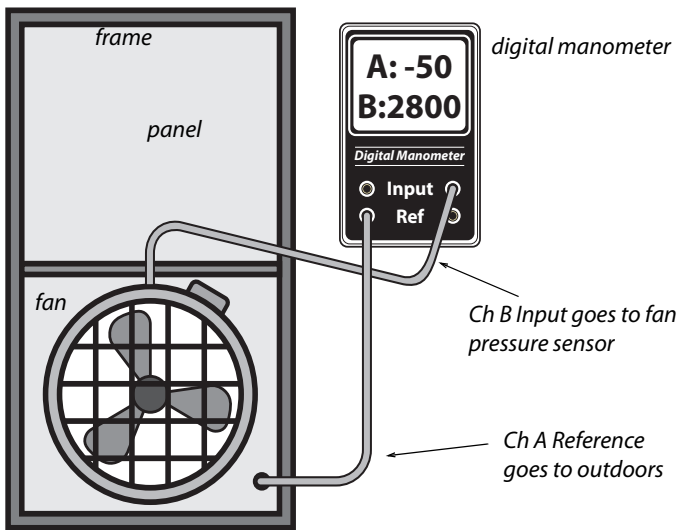

### 12.2.1 Blower-Door Principles

The blower door creates a 50-pascal pressure difference across the building envelope and measures fan pressure in order to cal-

culate airflow in cubic feet per minute ( $CFM_{50}$ ) to estimate the leakiness of homes. The blower door also creates pressure differences between rooms in the house and intermediate zones like attics and crawl spaces. These pressure differences can give clues about the location and combined size of a home's hidden air leaks.

**Blower-door test:** Air barriers are tested during a blower-door test, with the house at a pressure of 50 pascals negative with reference to outdoors. This house has 2800  $CFM_{50}$  of air leakage. Further diagnostic tests can help determine where that leakage is coming from.

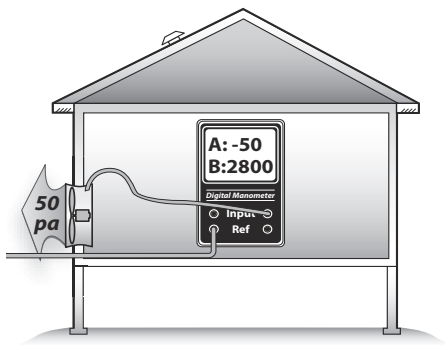

## Blower-Door Terminology

Connecting the digital manometer's hoses correctly is essential for accurate testing.

This method uses the phrase *with-reference-to (WRT)*, to distinguish between the input zone and reference zone for a particular measurement. The outdoors is the most commonly used reference zone for blower-door testing. The reference zone is considered to be the zero point on the pressure scale.

For example, *house WRT outdoors = -50 pascals* means that the house (input) is 50 pascals negative compared to the outdoors (reference or zero-point). This pressure reading is called the house pressure.

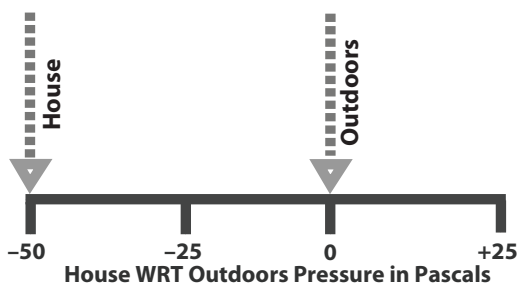

**Digital manometers:** Used to diagnose house and duct pressures quickly and accurately.

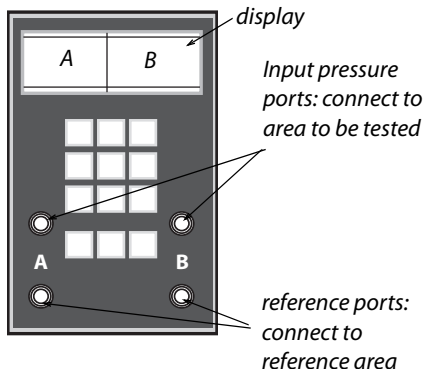

## Low-Flow Rings

During the blower-door test, the manometer measures airflow through the fan. This airflow ( $CFM_{50}$ ) is the primary measurement of a home's airtightness and is directly proportional to the surface area of the home's air leaks. For the blower door to measure airflow accurately, the air must be flowing at an adequate speed. Tighter buildings and smaller buildings don't have enough air leakage to create an adequate airspeed to create the minimum fan pressure. This low-flow condition requires using one or two low-flow rings, to reduce the blower-door fan's opening and to increase air speed, fan pressure, and measurement accuracy.

When the air speed is too low, the DG-700 displays "LO" in the Channel B display. After installing one of the low-flow rings, follow the manufacturer's instructions for selecting the proper range or configuration on the digital manometer.

## 12.2.2 Preparing for a Blower-Door Test

Preparing the house for a blower-door test involves putting the house in its normal heating-season operation with all conditioned zones open to the blower door. Try to anticipate safety problems that the blower-door test could cause, particularly with combustion appliances.

- Identify the location of the thermal boundary and determine which house zones are conditioned.
- Identify large air leaks that could prevent the blower door from achieving adequate pressure, such as a pet-door.
- Put the house into its heating-season operation with windows, doors, and vents closed and air registers open.
- Turn off combustion appliances temporarily.
- Open interior doors so that all indoor areas inside the thermal boundary are connected to the blower door. This could include the basement, conditioned kneewall areas, and closets.

### Avoiding Risky Situations

Don't perform a blower-door test in risky situations like the following until you remove the risk or perform an acceptable building repair.

- A wood stove is burning or contains ashes that may be pulled into the home.
- Holes in the ceiling that could lead to dust pollution during a blower-door test.
- Extremely weak building components, like a poorly installed suspended ceiling or loose wood wall paneling.
- Lead or asbestos dust is present.

### 12.2.3 Blower-Door Test Procedures

Follow this general procedure when performing a blower-door test.

- ✓ Set up the house for winter conditions with exterior doors, primary windows and storm windows closed. The door to the basement should be either open or closed, according to whether or not the basement is considered to be within the thermal boundary.
- ✓ Install blower-door frame, panel, and fan in an exterior doorway with a clear path to outdoors. On windy days, install the blower door on the home's leeward side if possible. Pay attention to the blower door's location and any other conditions that may affect test results.
- ✓ Follow manufacturer's instructions for fan orientation and digital-manometer setup for either pressurization or depressurization. Depressurization is the most common orientation.
- ✓ Connect Channel A of the digital manometer to measure *house WRT outdoors*. Place the outside hose at least 5 feet away from the fan.
- ✓ Connect Channel B to measure *fan WRT zone near fan inlet*. Don't place the hose directly in front of the fan intake.
- ✓ Ensure that children, pets, and other potential interferences are at a safe distance from the fan.

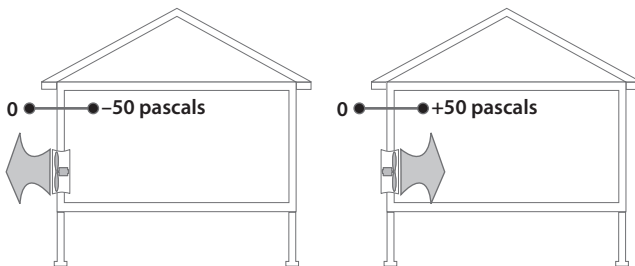



## Conducting the Blower-Door Test

Follow these instructions for performing a blower-door test, when using a DG700 digital manometer.

1. Turn on the manometer by pushing the ON/OFF button.
2. Select the MODE: PR/FL@50.
3. Select the correct DEVICE that matches the blower door you're using.
4. With the fan covered, conduct the BASELINE procedure to cancel out the background wind and stack pressures. Let the manometer average the baseline pressure for at least 30 seconds.
5. Remove the cover from the blower-door fan. Complete the next two steps for tighter buildings.
6. Install the flow ring in the blower-door fan which matches the expected flow rate. The fan pressure should be at least 25 Pa while measuring CFM@50.
7. Push CONFIG or Range button until you match the flow ring being used.
8. Turn on the blower-door fan slowly with the controller. Increase fan speed until the building depressurization on the Channel A screen is between  $-45$  and  $-55$  pascals. The reading doesn't need to be exactly  $-50$  pascals.
9. The Channel B screen displays the single-point CFM<sub>50</sub> air leakage of the building. If this number is fluctuating a lot, push the TIME AVG button to increase the averaging time period.
10. You can also use the cruise-control function to automatically control the fan speed to create and hold  $-50$  pascals of pressure.

## Blower-Door Test Follow-Up

Be sure to return the house to its original condition.

- ✓ Inspect combustion appliance pilot lights to ensure that blower-door testing didn't extinguish them.
- ✓ Reset thermostats of heaters and water heaters that were turned down for testing.
- ✓ Remove any temporary plugs that were installed to increase house pressure.
- ✓ Document the location where the blower door was installed.
- ✓ Document any unusual conditions affecting the blower-door test.



**Video: Setting up the DG700**— How to set up the DG700 manometer for diagnostic testing.

### 12.2.4 Approximate Leakage Area

There are several ways to convert blower-door  $CFM_{50}$  measurements into square inches of total leakage area. A simple and rough way to convert  $CFM_{50}$  into an approximate leakage area (ALA) is to divide  $CFM_{50}$  by 10. The ALA can help you visualize the size of openings in a home or section of a home.

$$ALA \text{ (SQUARE INCHES)} = CFM_{50} \div 10$$

## 12.3 MULTIFAMILY AIRTIGHTNESS TESTING

Air sealing, indoor air quality, and fire safety complement one another in multifamily buildings. Beyond sealing leaks in the exterior envelope, the most universal concept in multifamily air

sealing and airtightness testing is compartmentalization. Compartmentalization means sealing the air leaks between dwelling units to provide these benefits.

- Prevent odors traveling from one dwelling unit to another.

# Multifamily Air-Leak Locations

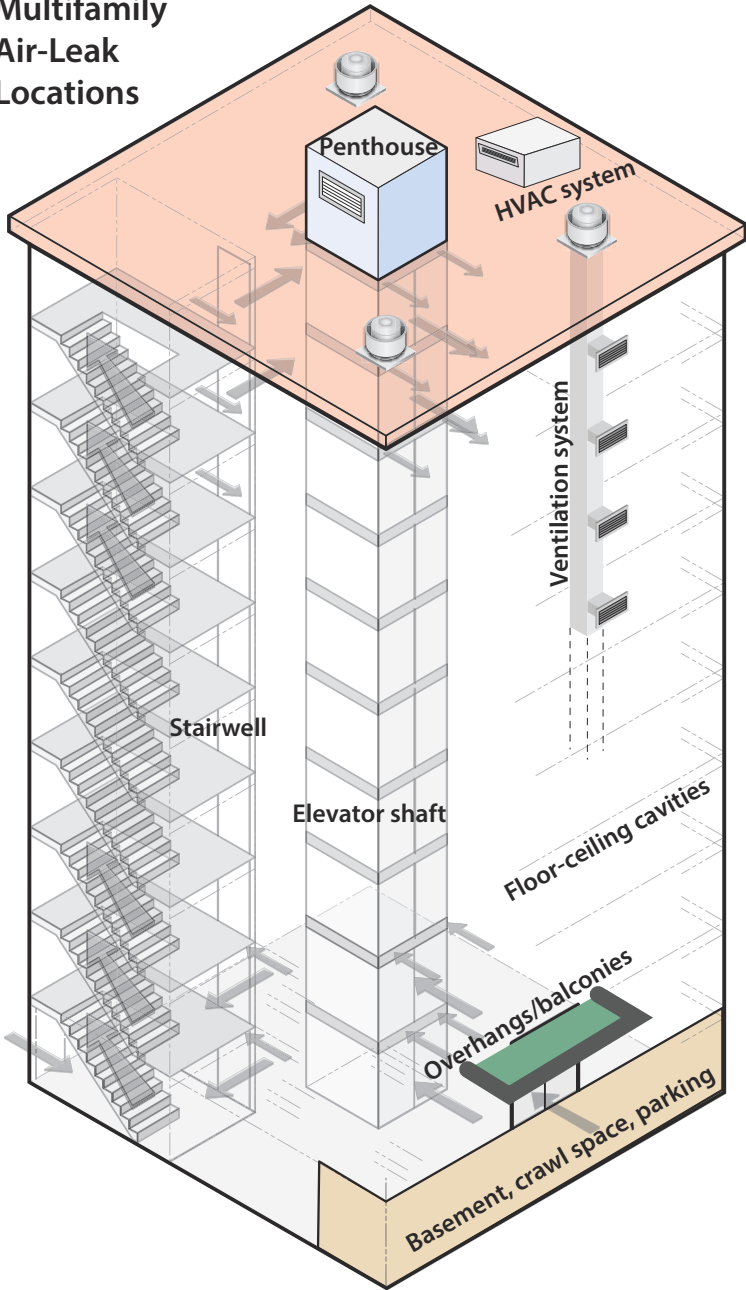

- Prevent the rapid spread of fire and smoke from one dwelling to another.
- Save energy by sealing air leaks and reducing the stack effect.

Leak-testing multifamily buildings is considerably more difficult than testing single-family homes. A whole-building blower-door test is the ideal, but is often impossible because of the huge airflow needed to pressurize the building along with the practical problems of testing a building with many occupants. These practical problems often necessitate zone testing and compartmentalization testing.

### 12.3.1 Testing Equipment

The quality and quantity of test equipment and the experience of the testing technicians determines the effectiveness of the testing. The larger the building, the more air-moving horsepower and technology the testing equipment requires.

Several software packages can automate the process of monitoring multiple blower doors and tracking pressures throughout a large building. Wireless sensors and wireless gauges make the process of remote measurement more practical.

Detailed instructions about operating a large-building air-leakage testing system are beyond the scope of this field guide.

### 12.3.2 Multifamily Air Leakage

Energy auditors develop an air sealing strategy by evaluating the chase leakage, according to the presence and location of the following building components.

- Direct air leakage through roofs, walls, and foundations.
- Vertical chases; including stairs and elevators
- Leaks through floors allowing airflow from one floor to another.

See the following sections for more information on multifamily air leakage.

- [“Weatherization Materials” on page 95](#)
- [“Air-Sealing Attics and Roofs” on page 123](#)
- [“Air Sealing Walls” on page 171](#)
- [“Air Sealing Foundations and Floors” on page 208](#)

### 12.3.3 Multifamily Blower-Door-Test Strategies

Here we discuss three different strategies for blower-door testing a multifamily building: the whole-building test, the compartmental test, and the guarded test.

Testers also measure zonal pressures to evaluate air barriers in multifamily buildings, like they do in single-family dwellings.

#### Whole-Building Test

Although increasingly difficult as buildings get larger, the whole-building blower-door test is a preferred approach. The testers usually need multiple blower doors for this test along with an automated blower-door-testing system.

The whole-building test provides an air-leakage measurement for the entire building. Also, this blower-door test gives the best information about where the critical leaks to outdoors are located.

#### Compartmental Test

The compartmental test requires only one blower door. This test measures air leakage to both the outdoors and indoors.

The compartmental approach gives the energy auditor a sample of the air leaks in a single dwelling unit. The leaks in this single unit may inform the auditor about typical leaks in all dwelling units or in units with the same characteristics.

## Guarded Test

Testers use the guarded test when they want to measure a single dwelling unit's air leakage to outdoors. This test is another strategy to characterize a single unit—like the compartmental test—by only measuring leakage to outdoors. This test requires pressurizing surrounding dwelling units with the same pressure applied to the tested unit.

## Zonal Pressures

Creating and measuring zonal pressures is one of the most effective ways to evaluate air leakage in multifamily buildings. Testers observe the building's assemblies and architectural features and formulate assumptions and questions to guide their air-leakage testing and air sealing.

The testers may decide to isolate various zones and assemblies to determine their individual leakage to outdoors or to adjacent zones. The goal is a testing and air-sealing process that is cost-effective. The tests may be quantitative or qualitative. Here are some zones and assemblies that you may want to pressure-test.

- Stairwells and elevator shafts.
- Ventilation and HVAC ducts, duct joints, and duct chases.
- Overhangs and balconies.
- Basements, crawl spaces, and penthouses.
- Floor and ceiling cavities.

The next section, *“Testing Air Barriers” on page 555*, gives many examples of zone pressure testing.

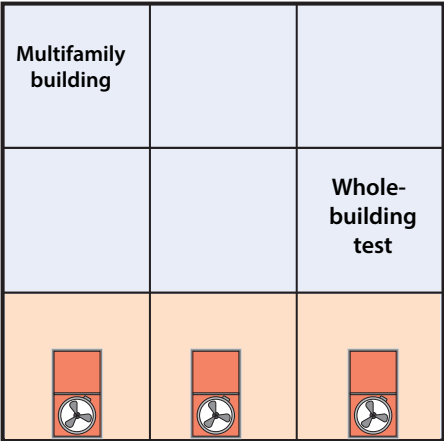

**Whole-building test:** Multiple blowers in entrances pressurize the whole building at once. A preferred method but sometimes impractical in existing buildings.

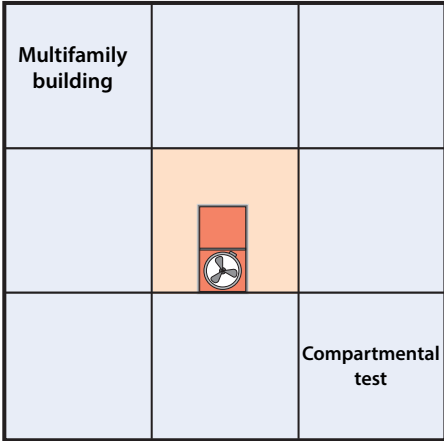

**Compartmental test:** A single blower door pressurizes a single dwelling unit. Identifies features of the unit that leak air to the outdoors and to surrounding units.

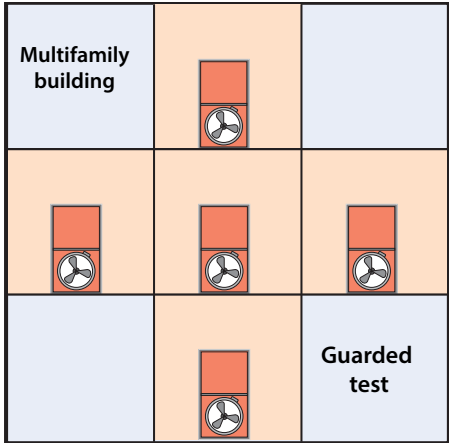

**Guarded test:** Attempts to measure the leakage to outdoors of a single dwelling unit. One blower door measures the units air leakage while other blower doors pressurize adjacent units to the same negative or positive pressure.

*Based on Sean Maxwell*



## 12.4 TESTING AIR BARRIERS

Leaks in air barriers cause energy and moisture problems in many homes. Air-barrier leak-testing avoids unnecessary visual inspection and unnecessary air sealing in hard-to-reach areas.

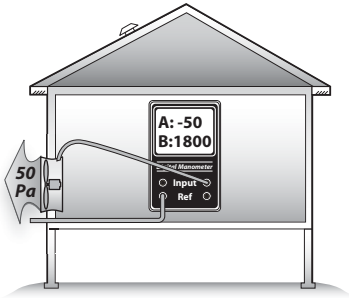

**Blower-door test:** Air barriers are tested during a blower-door test, with the house at a pressure of 50 pascals negative with reference to outdoors. This house has 1800 CFM<sub>50</sub> of air leakage. Further diagnostic tests can help determine where that leakage is coming from.

Advanced pressure tests measure pressure differences between zones in order to estimate air leakage between zones. Use these tests to make decisions about where to direct your air-sealing efforts, for example.

- Evaluate the airtightness of portions of a building's air barrier, especially floors and ceilings.
- Decide which of two possible air barriers to air seal — for example, the floor versus foundation walls.
- Determine whether building cavities like porch roofs, floor cavities, and overhangs are conduits for air leakage.
- Determine whether building cavities, intermediate zones, and ducts are connected together through air leaks.
- Estimate the air leakage in CFM<sub>50</sub> through a particular air barrier, for the purpose of estimating the effort and cost necessary to seal the leaks.

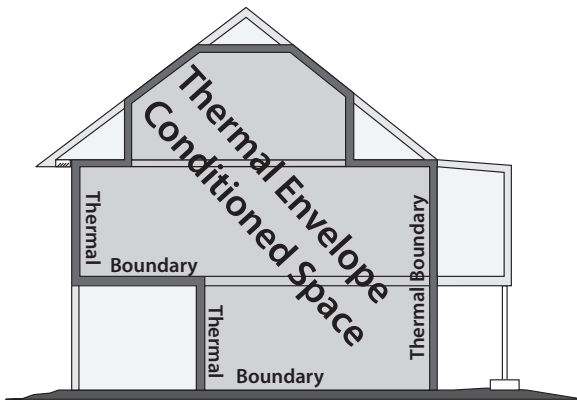

## Air-Barrier Test Results

Air-barrier tests provide a range of information from simple clues about which parts of a building leak the most, to specific estimates of the airflow and hole size through a particular air barrier.

The next table shows examples of how common building materials perform as air barriers. This information is helpful in interpreting blower-door tests and selecting air-sealing materials.

**Table 12-1: Building Components and Their Air Permeance**

<b>Good air barriers: &lt;2 CFM<sub>50</sub> per 100 sq. ft.</b>	<b>Poor air barriers: 10–1000 CFM<sub>50</sub> per 100 sq. ft.</b>
5/8" oriented strand board	5/8" tongue-and-groove wood sheathing
1/2" drywall	6" fiberglass batt
4-mil air barrier paper	1.5" wet-spray cellulose
Asphalt shingles and perforated felt over 1/2" plywood	wood siding over plank sheathing
1/8" tempered hardboard	wood shingles over plank sheathing
painted un-cracked lath and plaster	blown fibrous insulation
Measurements taken at 50 pascals pressure. Based on information from: "Air Permeance of Building Materials" by Canada Mortgage Housing Corporation, and estimates of comparable assemblies by the author. Although cellulose reduces air leakage when blown into walls, it isn't considered an air-barrier material.	

### 12.4.1 Primary Versus Secondary Air Barriers

A home's air barrier should be a material that is continuous, sealed at the seams, and impermeable to airflow. Where there are two possible air barriers, in an attic for example, the most airtight barrier is the primary air barrier and the least airtight is the secondary air barrier.

The primary air barrier should be adjacent to the insulation to ensure the insulation's effectiveness. We use pressure-diagnostic testing to verify that the insulation and the primary air barrier are together. Sometimes we're surprised during testing to find that our assumed primary air barrier is actually secondary, and the secondary air barrier is primary.

Intermediate zones are unconditioned spaces that are sheltered within the exterior envelope of the house. Intermediate zones can be located inside or outside the home's primary air barrier. Intermediate zones include: unheated basements, crawl spaces, attics, enclosed porches, and attached garages.

Intermediate zones have two potential air barriers: one between the zone and house and one between the zone and outdoors. For example, an attic or roof space has two air barriers: the ceiling and roof. You should know which air barrier is the tightest.

## 12.4.2 Simple Pressure Tests

Blower-door tests give us valuable information about the relative leakiness of rooms or sections of the home. Listed below are five simple methods.

1. *Feeling zone air leakage:* Close an interior door partially so that there is a one-inch gap between the door and door jamb. Feel the airflow along the length of that crack, and compare that airflow intensity with airflow from other rooms, using this same technique.
2. *Observing the ceiling/attic floor:* Pressurize the home and observe the top-floor ceiling from the attic with a good flashlight. Air leaks show in the movement of loose-fill insulation, blowing dust, fluttering cobwebs, etc. You can also use a small piece of tissue paper or smoke generator to discover air movement. An infrared camera also works well for identifying leakage areas during heating and cooling seasons.
3. *Observing smoke movement:* Pressurize the home and observe the movement of smoke through the house and out of its air leaks.
4. *Room pressure difference:* Check the pressure difference between a closed room or zone and the main body of a home. Larger pressure differences indicate larger potential air leakage within the closed room or else a

tight air barrier between the room and main body. A small pressure difference means little leakage to the outdoors through the room or a leaky air barrier between the house and room.

5. *Room airflow difference:* Measure the house CFM<sub>50</sub> with all interior doors open. Close the door to a single room, and note the difference in the CFM<sub>50</sub> reading. The difference is the approximate leakage through that room's air barrier.

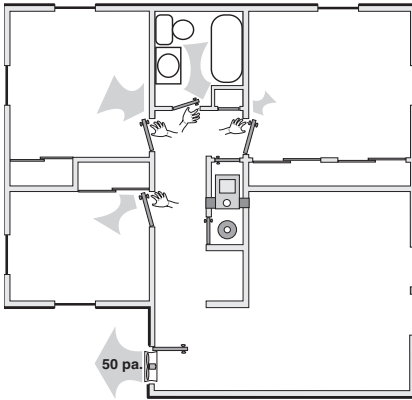

**Interior door test:** Feeling airflow with your hand at the crack of an interior door gives a rough indication of the air leakage coming from the outdoors through that room.

Tests 1, 2, and 3 present good client education opportunities. Feeling airflow or observing smoke are simple observations, but have helped identify many air leaks that could otherwise have remained hidden.

When airflow within the home is restricted by closing a door, as in tests 4 and 5, it may take alternative indoor paths that render these tests somewhat misleading. Only practice and experience can guide your decisions about the applicability and usefulness of these general indicators.



**Video: Simple pressure diagnostics—** How to perform pressure diagnostics during a blower-door test.

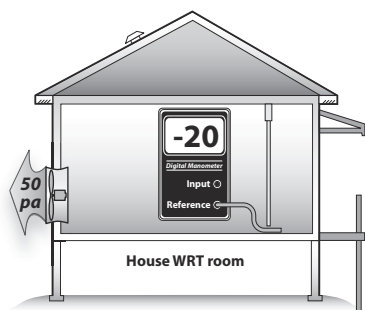

**Bedroom test:** This bedroom pressure difference may be caused by its leaky exterior walls or tight interior walls, separating it from the main body of the home. This test can determine whether or not a confined combustion zone is connected to other rooms.

### 12.4.3 Simple Zone Pressure Testing

Manometers aren't limited to finding indoor WRT outdoor differences. They can also measure pressure differences between the house and its intermediate zones during blower-door tests. The purpose of these tests is to evaluate the air-tightness of the home's interior air barriers.

The blower door, when used to create a house-to-outdoors pressure of  $-50$  pascals, also creates house-to-zone pressures of between  $0$  and  $-50$  pascals in the home's intermediate zones. The amount of depressurization depends on the relative leakiness of the zone's two air barriers.

For example, an attic with a fairly airtight ceiling and a well-ventilated roof indicates that it is mostly outdoors by showing a house-to-zone pressure of  $-45$  to  $-50$  pascals. The leakier the ceiling and the tighter the roof, the smaller that the negative house-to-zone pressure will be. This holds true for other intermediate zones like crawl spaces, attached garages, and unheated basements.



**Video: Zone pressure diagnostics**— Using a blower door and manometer to qualify air leakage across various parts of the pressure boundary.

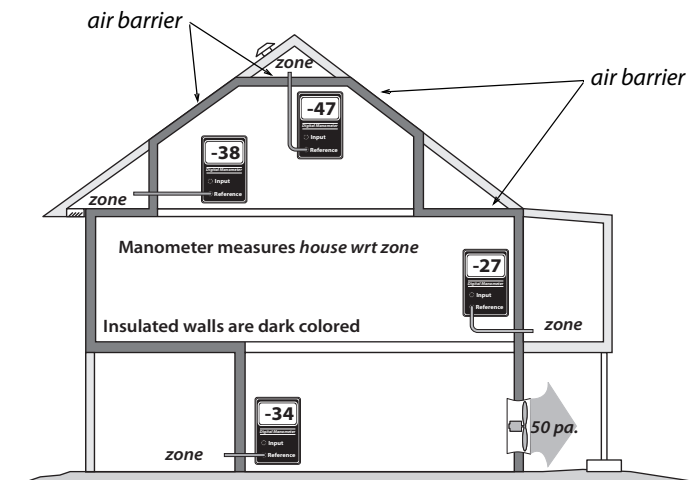

**Pressure-testing building zones:** Measuring the pressure difference across the assumed thermal boundary (*house wrt zone*) tells you whether the air barrier and insulation are aligned. If the manometer reads close to  $-50$  pascals, the air barrier and insulation are aligned and the tested zones are well-connected to outdoors.

## Zone Leak-Testing Methodology and Diagnostics

Depressurize house to  $-50$  pascals with a blower door.

1. Find an existing hole, or drill a hole through the floor, wall, or ceiling between the conditioned space and the intermediate zone.
2. Connect the reference port of a digital manometer to a hose reaching into the zone.
3. Leave the input port of the digital manometer open to the indoors.
4. Read the negative pressure given by the manometer. This reading is the house-to-zone pressure, which will be  $-50$  pascals, if the air barrier between house and zone is airtight and the zone itself is well-connected to outdoors.

- If the reading is significantly less negative than  $-45$  pascals, find the air barrier's largest leaks and seal them.
- Repeat steps 1 through 5, performing more air-sealing as necessary, until the pressure is as close to  $-50$  pascals as possible.

For a method of estimating hole size, see *“Pressure Diagnostics – Hole Size Ratios”* on page 554.

**Interpreting house-to-zone pressure:** The greater the negative number the better the air barrier is performing.

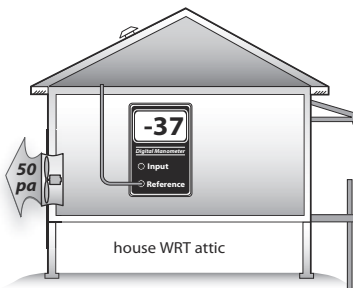
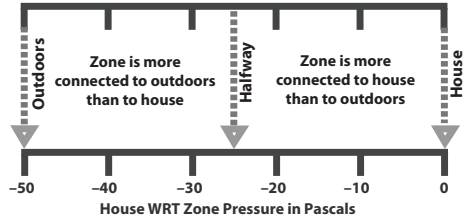

**House-to-attic pressure:** This commonly used measurement is convenient because it requires only one hose.

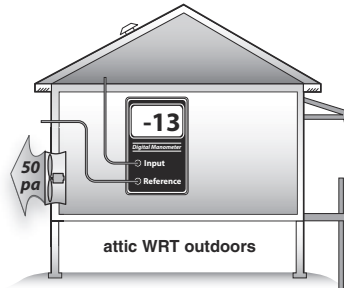

**Attic-to-outdoors pressure:** This measurement confirms the first because the two add up to  $-50$  pascals.

## Leak-Testing Building Cavities

Building cavities such as wall cavities, floor cavities between stories, and dropped soffits in kitchens and bathrooms can also be tested as described above to determine their connection to the outdoors as shown here.



*These examples assume that the manometer is outdoors with the reference port open to outdoors*

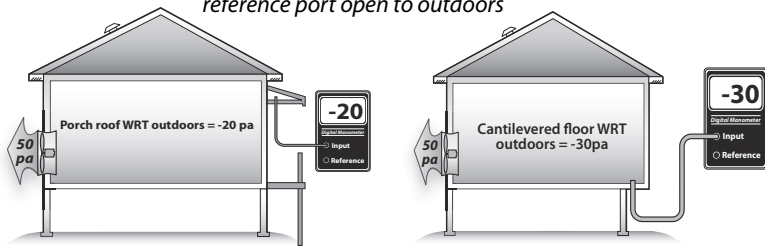

**Porch roof test:** If the porch roof were outdoors, the manometer would read near 0 pascals. We hope that the porch roof is outdoors because it is outside the insulation. We find, however, that it is partially indoors, indicating that it may harbor significant air leaks through the thermal boundary.

**Cantilevered floor test:** We hope to find the cantilevered floor to be indoors. A reading of -50 pascals would indicate that it is completely indoors. A reading less negative than -50 pascals is measured here, indicating that the floor cavity is partially connected to outdoors.

## Testing Zone Connectedness

Sometimes it's useful to determine whether two zones are connected by a large air leak. Measuring the house-to-zone pressure during a blower-door test, before and then after opening the other zone to the outdoors, can establish whether the two zones are connected by a large air leak. You can also open an interior door to one of the zones and check for pressure changes in the other zone.

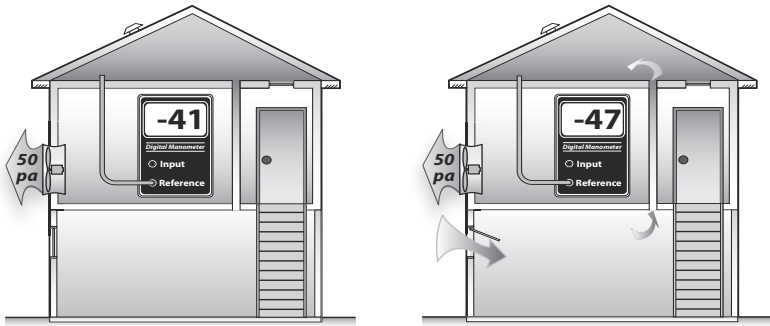

**Zone connectedness:** The attic measures closer to outdoors after the basement window is opened, indicating that the attic and basement are connected by a large bypass.

## Leak-Testing Building Cavities

You can also test building cavities such as wall cavities, floor cavities between stories, and dropped soffits in kitchens and bathrooms with a digital manometer to evaluate their possible connection to the outdoors by way of air leaks.

### 12.4.4 Locating the Thermal Boundary

When retrofitting, you need to decide where to air seal and where to insulate. Zone pressures are one of several factors used to determine where the thermal boundary should be.

For zone leak-testing, the house-to-zone pressure is often used to determine which of two air barriers is tighter.

- Readings of negative 25-to-50 pascals house-to-attic pressure mean that the ceiling is tighter than the roof. If the roof is almost completely airtight, achieving a 50-pascal house-to-attic pressure difference may be difficult. However if the roof is well-ventilated, achieving a near-50-pascal difference should be possible.
- Readings of negative 0-to-25 pascals house-to-attic pressure mean that the roof is tighter than the ceiling. If the

roof is well-ventilated, the ceiling has even more leakage area than the roof's vent area.

- Readings around  $-25$  pascals house-to-attic pressure indicate that the roof and ceiling are equally airtight or leaky.

Pressure readings more negative than  $-45$  pascals indicate that the ceiling (typical primary air barrier) is adequately airtight. Less negative pressure readings indicate that air leaks should be located and sealed.

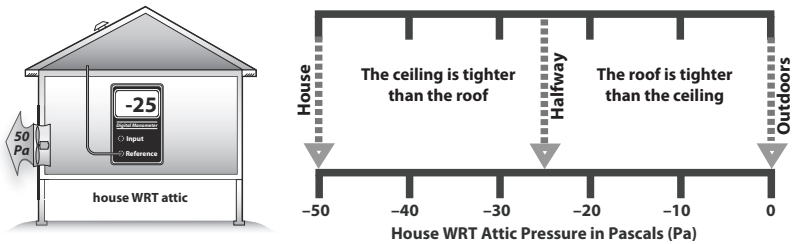

**Building-to-attic pressure:** This test allows the tester to evaluate the attic's two possible air barriers—the ceiling and the roof. The diagram shows how to determine which air barrier is tighter.

## Floor Versus Crawl Space

The floor shown here is tighter than the crawl-space foundation walls. If the crawl-space foundation walls are insulated, holes and vents in the foundation wall should be sealed until the pressure difference between the crawl space and outside is as negative you can make it — ideally more negative than  $-45$  pascals. A leaky foundation wall renders its insulation nearly worthless.

If the floor above the crawl space were insulated instead of the foundation walls in the above example, the air barrier and the insulation would be aligned.

If a floor is already insulated, it makes sense to establish the air barrier there. If the foundation wall is more airtight than the floor, that would be one reason to insulate the foundation wall.

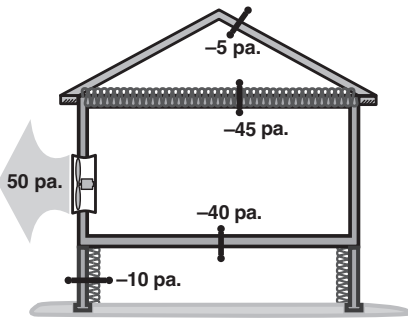

**Pressure measurements and air-barrier location:** The air barrier and insulation are aligned at the ceiling. The crawl-space pressure measurements show that the floor is the air barrier and the insulation is misaligned — installed at the foundation wall. We could decide to close the crawl space vents and air seal the crawl space. Then the insulation would be aligned with the air barrier.

## Attic Boundary

Generally, the thermal boundary (air barrier and insulation) should be between the conditioned space and attic. An exception would be insulating the roof to enclose an attic air handler and its ducts within the thermal boundary.

## Garage Boundary

The air barrier should always be between the conditioned space and a tuck-under or attached garage, to separate the living spaces from this unconditioned and often polluted zone.

## Duct Location

The location of ducts either within or outside the thermal boundary is an important factor in determining the cost-effectiveness of duct-sealing and insulation. Including the heating ducts within the thermal boundary is preferred because it reduces energy waste from both duct leakage and duct heat transmission.

For a method of estimating hole size, see *“Pressure Diagnostics – Hole Size Ratios”* on page 554

# APPENDICES

## A-1 R-VALUES FOR COMMON MATERIALS

Material	R-value
Fiberglass or rock wool batts and blown 1"	2.8–4.0
Blown cellulose 1"	3.0–4.0
Vermiculite loose fill 1"	2.7
Perlite 1"	2.4
White expanded polystyrene foam (beadboard) 1"	3.9–4.3
Polyurethane/polyisocyanurate foam 1"	6.2–7.0
Extruded polystyrene 1"	5.0
High-density 2-part polyurethane foam 1"	5.8–7.5
Low-density 2-part polyurethane foam 1"	3.6
Oriented strand board (OSB) or plywood 1/2"	1.6
Concrete or stucco 1"	0.1
Wood 1"	1.0
Carpet/pad 1/2"	2.0
Wood siding 3/8–3/4"	0.6–1.0
Concrete block 8"	1.1
Asphalt shingles	0.44
Fired clay bricks 1"	0.1–0.4
Gypsum or plasterboard 1/2"	0.4
Single pane glass 1/8"	0.9
Low-e insulated glass (Varies according to Solar Heat Gain Coefficient (SHGC) rating.)	3.3–4.2

# A-2 ASHRAE 62.2 DUCT SIZING

## Rated Fan CFM

50	80	100	125	150	200	250	300
----	----	-----	-----	-----	-----	-----	-----

Duct Dia.	Smooth Hard Duct - Maximum Duct Length in Feet							
3"	5	X	X	X	X	X	X	X
4"	114	31	10	X	X	X	X	X
5"	NL	152	91	51	28	4	X	X
6"	NL	NL	NL	168	112	53	25	9
7"	NL	NL	NL	NL	NL	148	88	54
8"	NL	NL	NL	NL	NL	NL	198	133

Duct Dia.	HVAC Flex Duct - Maximum Duct Length in Feet							
3"	X	X	X	X	X	X	X	X
4"	56	4	X	X	X	X	X	X
5"	NL	81	42	16	2	X	X	X
6"	NL	NL	158	91	55	18	1	X
7"	NL	NL	NL	NL	161	78	40	19
8"	NL	NL	NL	NL	NL	189	111	69

NL: No limit;

X: not allowed

Table assumes no elbows. Deduct 15 ft from allowable duct length for each elbow.

# A-3 FIRE TESTING AND RATING

Test/Rating	Description
ASTM E-136 or E-176	If a material passes this test, it is non-combustible.
ASTM E-119	Hourly rating of a wall when exposed to fire. Determines how long that the wall holds back heat and flames and maintains its structural integrity.
ASTM E-184	Hourly rating for a sealant system for a penetration through a fire-rated (ASTM E119) assembly.
ASTM E-84	Test measures how fast flames spread in a fire tunnel lined with the tested material, compared to red oak, which is given a flame spread of 100. <b>This test classifies materials as Class I, II, or III (or A, B, &amp; C) See flame spread in the three rows below.</b>
Class I or A	Flame spread less than or equal to 25
Class II or B	Flame spread 26 to 75
Class III or C	Flame spread 76 to 200
FM 4880 or UL-1040	The fire burns in a 90-degree corner of a wall assembly containing the tested material. Approximates the performance of a material installed in a typical building assembly. The test measures the fire resistance of an assembly in 15 minutes of fire exposure at 40 kW and 160 kW.
ISO 9705 UL 1715	Like the corner test except the fire burns in a room with its wall and ceiling assembly sheeted with the tested finish material. The measures time with flame spread and smoke developed ratings relative to Class I, II, and III assemblies.
UL181	Duct materials, duct-closure systems, and duct sealants so labeled pass UL fire-resistance tests.

## **A-4 MAXIMUM CAZ DEPRESSURIZATION**

<b>Appliance Type</b>	<b>Max. Depress.</b>
Atmospheric water heater only (Category I, natural draft), open-combustion appliances	-2 Pa
Atmospheric water heater (Category I, natural draft) and atmospheric furnace (Category I, natural draft), common-vented, open-combustion appliances	-3 Pa
Gas furnace or boiler, Category I or Category I fan-assisted, open-combustion appliances	-5 Pa
Oil or gas unit with power burner, low- or high-static pressure burner, open combustion appliances	-5 Pa
Closed, controlled wood-burning appliances	-7 Pa
Induced-draft appliances (fan at point of exit at wall), Category I with induced draft, open-combustion appliances	-15 Pa
Pellet stove with draft fan and sealed vent	-15 Pa
Gas appliances, Category III vented through the wall, forced draft, open-combustion appliances	-15 Pa
Direct-vent, sealed combustion appliances with forced draft	-25 Pa



## **A-5 CARBON MONOXIDE LIMITS**

<b>Equipment</b>	<b>CO Limit</b>
Central Furnace (all categories)	400 ppm air free; PMI
Boiler	400 ppm air free; PMI
Floor Furnace	400 ppm air free; PMI
Gravity Furnace	400 ppm air free; PMI
Wall Furnace (BIV)	200 ppm air free; PMI
Wall Furnace (Direct Vent)	400 ppm air free; PMI
Vented Room Heater	200 ppm air free; PMI
Unvented Room Heater	200 ppm air free; PMI
Water Heater	200 ppm air free; PMI
Oven / Broiler	225 ppm as measured
Clothes Dryer	400 ppm air free; PMI
Refrigerator	25 ppm as measured
Gas Log (gas fireplace)	25 ppm as measured in vent
Gas Log (installed in wood burning fireplace)	400 ppm air free in firebox

Based on ANSI BSR/BPI-1200-S-201x

# A-6 REFRIGERATOR DATING CHART

Refrigerators are listed by brand name, followed by the coding system. If several manufacturers used the same system, they are listed together. Some rules of thumb for easy identification are: (1) Refrigerators that are any color of green, brown, yellow, pink, or blue (actually KitchenAid makes a new unit in cobalt blue) have mechanical handles; have doors held shut with magnetic strips; have rounded shoulders; have a chromed handle; or have exposed "house door" type hinges and at least 10 years old, and (2) the following brands have only been manufactured since around 1984 - Roper, Estate, KitchenAid, Caloric, Modern Maid, and Maytag.

Brand(s)	What to look for	What to avoid	How to decode	Example			
Montgomery Ward, Signature (2000)	Serial # - 1 <sup>st</sup> two digits	n/a	Reverse the digits	56XXXX = 1965			
Sears, Kenmore, Coldspot	Model # - 1 <sup>st</sup> & 3 <sup>rd</sup> digits after ( )	n/a	Combine the digits	xx6x2xxx = 1962			
Whirlpool	Model # - 1 <sup>st</sup> 3 letters (pre 1982) Serial # - 2 <sup>nd</sup> digit (post 1982)	Serials with letters	No need as 1 <sup>st</sup> two digits Add "198" to it	ABCxxx = pre 1982 x2xxx = 1982			
Amana	Serial # - 1 <sup>st</sup> digit (pre 1986)	n/a	BLACKHORSE B=1, L=2	Hxxx = 1966 or 1976 61 is the oldest			
Frigidaire	Serial # - 1 <sup>st</sup> & 4 <sup>th</sup> digit (pre 1989)	Serials with no letter in the 4 <sup>th</sup> space	Add "196, 197, or 198" to the 1 <sup>st</sup> digit. The letter in the 4 <sup>th</sup> space is a month code used only on older models.	3xxBxx = 1973 or 1983			
Gibson, Kelvinator	Serial # - 3 <sup>rd</sup> digit (pre 1989)	n/a	Add "196, 197, or 198" to it	xx3xx = 1963 or 73 or 83			
White, Westinghouse	Serial # - 2 <sup>nd</sup> letter (pre 1989)	Serials without letters	A, V, W=78, B=79, C=80 etc. pre-1978, R=74, U=77 etc.	xLxxx = 1988 74 is the oldest year			
Tappan, O'Keefe & Merritt	Serial # - 7 <sup>th</sup> digit (pre 1989)	n/a	Add "196, 197, or 198" to it	xx xxx-88xx = 1988 or 78 or 88			
Admiral, Crosley, Norge, Magic Chef, Jenn Air	Serial # - last letter	n/a	A=1950 or 1974 (+14 yrs) B=1951 or 1975, etc.	xxxxxD = 1953 or 1977			
General Electric (GE)	Serial # - 2 <sup>nd</sup> letter	n/a	See chart below	xGxxx = 1950 or 1980			
Hotpoint	Same as GE with some exceptions. See GE and Hotpoint exceptions chart below						
GE Decoder Chart:	A = 44, 65, 77, 89 H = 51, 81, 93 R = 58, 84	B = 45, 66 J = 52 S = 59, 85	C = 46, 67 K = 53 T = 60, 74, 86	D = 47, 68, 78, 90 L = 54, 70, 82, 94 V = 61, 75, 87	E = 48, 69 M = 55, 71, 83 W = 62	F = 49, 79, 91 N = 56, 72 X = 63, Y = 64	G = 50, 80, 92 P = 57, 73 Z = 76, 88
Hotpoint Exceptions:	U = 61, V = 62, W = 63, X = 64, Y = 65, Z = 66, A = 67, B = 68						

Revised 5/6/94

# A-7 BPI COMBUSTION-TESTING DIAGRAMS

ANSI BSR/BPI - 1200-S-201x Combustion Testing Timeline

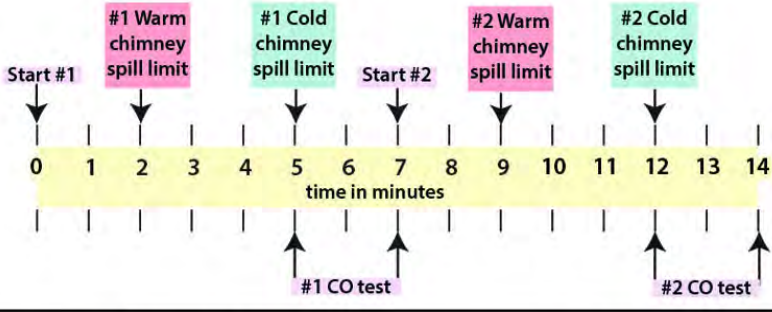

ANSI BSR/BPI - 1200-S-201x Combustion Testing Procedure

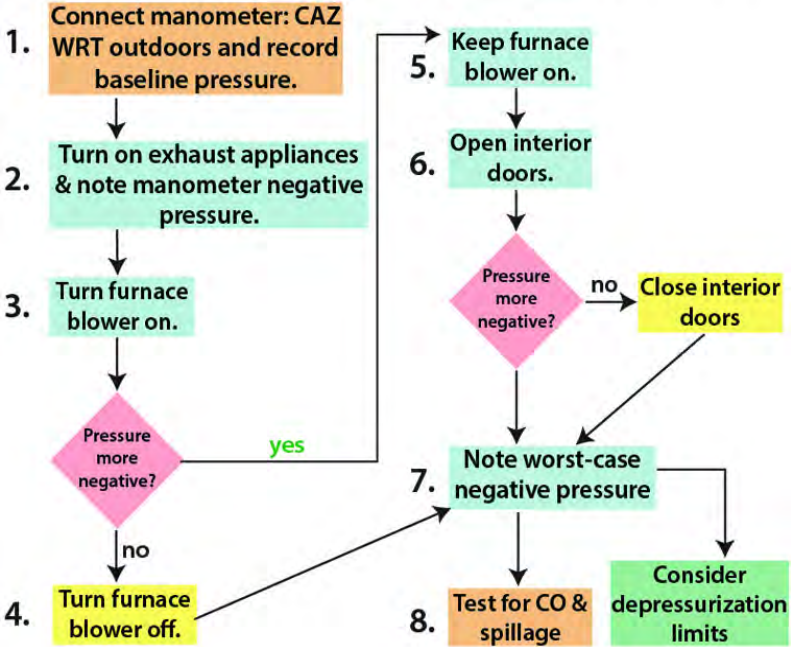

Spillage limits: 2 minutes warm chimney; 5 minutes cold chimney  
 CO limits (ppm): 400 AF/200 AM for furnaces and boilers  
 200 AF/100 AM for water heaters and space heaters  
 AF = air free; AM = as measured; ppm = parts per million

# A-8 PRESSURE DIAGNOSTICS – HOLE SIZE RATIOS

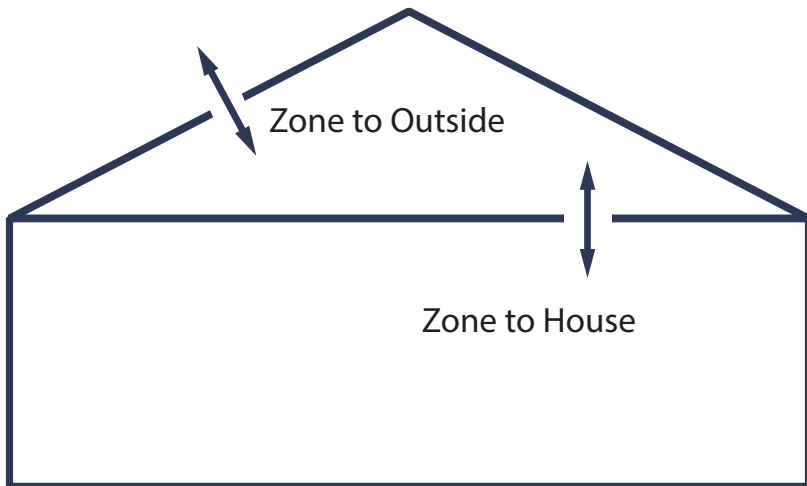

Zone Pressures (Pa.)		Relative Size of the Holes	
House-Zone	Zone-Outside	House - Zone	Zone-Outside
12	38	2	1
25	25	1	1
37	13	1/2	1
41	9	1/3	1
45	5	1/4	1
48	2	1/8	1
49	1	1/13	1

Source: Michael Blasnik and Jim Fitzgerald

# A-9 HOUSE DEPRESSURIZATION CHART

spillage goes up with depressurization

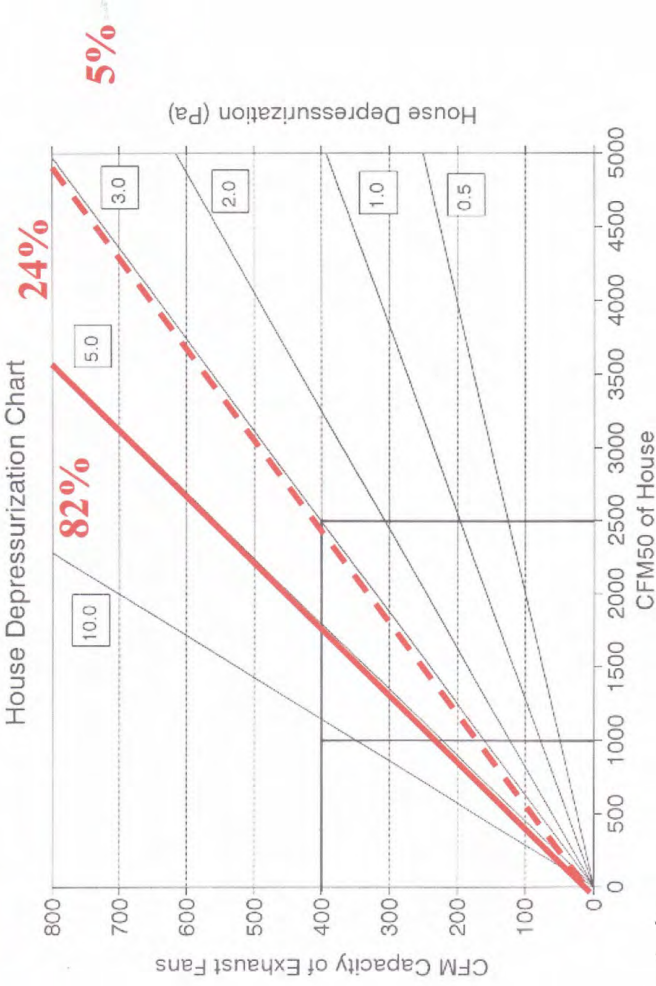

From 1075 tests in Mpls Sound Program



# GLOSSARY

*Abatement* : A measure or set of measures designed to permanently eliminate a hazard

*Absolute humidity*: Air's moisture content expressed in weight of water vapor per standard weight (pounds, grams) of dry air.

*Absorptance*: The ratio of a solar energy absorbed to incident solar. Also called absorbtivity.

*Absorption*: A solid material's ability to draw in and hold liquid, gas, or radiant energy.

*Accent lighting*: Illumination of walls or other surfaces, to spread light and reduce contrast in an indoor or outdoor area.

*Acoustical Sealant*: Sealing agent used to minimize sound transmission through a joint.

*ACH50*: The number of times in one hour that all of the air in a home is replaced by outside air during a 50-pascal blower door test.

*Adsorption*: Adhesion of a thin layer of molecules to a surface they contact.

*Air barrier*: Any part of the building envelope that offers resistance to air leakage. The air barrier is effective if it stops most air leakage. The primary air barrier is the most effective of a series of potential air barriers.

*ACH<sub>50</sub>*: Air changes per hour at 50 pascals. The number of times the volume of air in a structure changes in one hour at the induced blower-door house pressure of 50 pascals.

*ACH<sub>nat</sub>*: Air changes per hour natural. The number of times the indoor air is exchanged with the outdoor air in one hour under natural driving forces, often written as just ACH.

*Air conditioning*: Cooling buildings with a refrigeration system. More generally means both heating and cooling.

*Air Conditioning Contractors of America (ACCA):* Industry group that promotes best practices and lobbies for the industry.

*Air exchange:* The process whereby indoor air is replaced with the outdoor air through air leakage and ventilation.

*Air-free carbon monoxide (ppm):* A measurement of CO in an air sample or flue gas that accounts for the amount of excess air (oxygen, O<sub>2</sub>) in the sample. It adjusts the as-measured CO ppm value, thus simulating air-free (oxygen-free) conditions in the sample. Measured in parts per million (ppm).

*Air handler:* A steel cabinet containing a blower with cooling and/or heating equipment, connected to ducts that transport indoor air to and from.

*Air-handling unit (AHU):* See air handler.

*Air leakage:* Uncontrolled ventilation through gaps in the air barrier. Typical sites of air leakage include around windows, pipes, wires and other penetrations.

*Air-impermeable insulation:* An insulation having an air permeance equal to or less than 0.02 L/s-m<sup>2</sup> at 75 Pa pressure differential tested according to ASTM E 2178 or E 283.

*Air sealing:* The systematic approach to reducing air leakage in a building.

*Albedo:* The ratio of reflected light to incident light.

*Altitude adjustment:* The input modification for a gas appliance installed at a high altitude. When a gas appliance is installed more than 2000 feet above sea level, The installer may reduce its input rating according to manufacturers' specifications.

*Ambient:* Of the surrounding area or environment.

*Ambient air:* Air in the habitable space. Also the air around a human observer.

*Ambient lighting:* Lighting spread throughout the lighted space for safety, security, and aesthetics.



*American Gas Association (AGA):* A trade association representing American natural gas supply companies. AGA collaborates with ASC and NFPA on the National Fuel Gas Code.

*American National Standards Institute, Inc. (ANSI):* A private non-profit organization that oversees the development of voluntary consensus standards for products, services, processes, systems, and personnel in the United States.

*American Society of Heating, Refrigeration, and Air Conditioning Engineers (ASHRAE):* A technical society for individuals and organizations interested in heating, ventilation, air-conditioning, and refrigeration. ASHRAE publishes standards and guidelines relating to HVAC systems and issues.

*American Society for Testing and Materials (ASTM) :* A standards organization that develops and publishes voluntary consensus technical standards for a wide range of materials, products, systems, and services.

*Amperage:* The rate that electrical current flows through an appliance at any given time; also called current.

*Ampere:* A unit that measures the rate that electrons move through a conductor.

*Anemometer:* A device that measures air speed, used in HVAC work to determine flow rates at registers.

*Annual Fuel Utilization Efficiency (AFUE):* A laboratory-derived efficiency for heating appliances that accounts for chimney losses, jacket losses, and cycling losses, but not distribution losses, fan energy, or pump energy.

*Annual return:* The annual savings divided by the initial cost of an ECM, expressed as a percent.

*Appliance:* Any device powered by electricity or combustible fuel.

*Approach temperature:* The temperature difference between the fluid inside a heat exchanger and the fluid outside of it.

*Aquastat*: A heating control device that controls the burner or the circulator in a hydronic heating system.

*Arc-fault circuit interrupter (AFCI)*: A circuit breaker that disconnects a circuit when it detects an electrical arc.

*Area*: Length x width = area.

*As-measured carbon monoxide*: A calculation of CO in parts per million (ppm) of a combustion-gas sample with the excess air (oxygen, O<sub>2</sub>), diluting the CO concentration removed by the calculator in the fuel-gas analyzer.

*ASHRAE*: American Society of Heating, Refrigerating, and Air-Conditioning Engineers. International technical society which develops standards for those concerned with refrigeration processes and the design and maintenance of indoor environments.

*ASHRAE 62.2-20xx*: Indoor air quality standard developed for low-rise residential buildings. Defines the roles of, and minimum requirements for mechanical and natural ventilation systems and the building envelope.

*Asbestos*: A fibrous mineral with fireproofing and insulating characteristics manufactured into a variety of building materials. Small, sharp, asbestos fibers are a known carcinogen when inhaled.

*Association of Energy Engineers (AEE)*: A professional organization for energy engineers. AEE offers many certification programs, including energy auditors and other energy experts.

*Association of Home Appliance Manufacturers (AHAM)*: Trade association representing the appliance manufacturing industry

*Asthma*: An acquired respiratory illness with strong correlation to buildings, moisture problems, and pets.

*Atmospheric appliance*: A combustion appliance that burns and exhausts its combustion gases at atmospheric pressure.

*Atmospheric pressure:* The weight of air and its contained water vapor on the surface of the earth. At sea level this pressure is 101,325 pascals or 14.7 pounds per square inch.

*Attic:* The unfinished space directly between the ceiling assembly of the top story and the roof assembly.

*Attic, habitable:* A finished or unfinished area, not considered a story. See the IRC for specific requirements.

*Audit:* The process of identifying energy conservation opportunities in buildings.

*Auxiliary heat:* Electric resistance heat in a heat pump that heats the building when the compressor isn't able to provide the entire heat capacity needed for cold weather.

*Awning window:* Awning windows are essentially casement windows that swing vertically.

*B-vent:* A double-wall pipe for gas and propane-fired combustion appliances.

*Backdrafting:* Continuous spillage of combustion gases from a vented combustion appliance into the conditioned space.

*Backdraft damper:* A damper, installed near a fan, that allows air to flow in only one direction.

*Backer rod:* Polyethylene foam rope used as a backer for caulking.

*Baffle:* 1. A lightweight plate that directs air from a soffit over attic insulation and along the bottom of the roof deck to ventilate the attic and cool the roof deck. 2. A plate or strip designed to retard or redirect the flow of flue gases.

*Balance point:* The outdoor temperature at which no heating is needed to maintain indoor comfort.

*Ballast:* A coil of wire or electronic device that provides a high starting voltage for a lamp and also limits the current flowing through it

*Balloon framing:* A method of construction in which the vertical framing members (studs) are continuous pieces running the entire height of the wall.

*Band joist:* See - Rim joist

*Barometric vent damper:* A device installed in the heating unit vent system to control draft. Usually used on oil-fueled heaters or gas heaters with power burners

*Barrier:* Material used to block passage or movement.

*Basement:* The portion of a building that is partly or completely below grade.

*Batt:* A blanket of preformed fibrous insulation designed to fill cavities.

*Beam:* A strong horizontal building support used to carry the weight of a floor or roof.

*Belly blow:* A process for re-insulating floor cavities with blown-in insulation.

*Belly return:* A configuration found in some mobile homes that uses the belly cavity as the return side of the heating/cooling distribution system.

*Belt rail:* A horizontal wall support for fastening siding.

*Bimetal element:* A metal spring, lever, or disc made of two dissimilar metals that expand and contract at different rates as the temperature around them changes. This movement operates a switch in the control circuit of a heating or cooling device.

*Blocking:* A construction element or material used to strengthen or to prevent the movement of air or insulation into or out of building cavities.

*Block frame:* A non-finned window frame for new or retrofit installation in a rough opening.

*Blower door:* A diagnostic tool used to quantify and locate air leakage in the building envelope and to help prioritize the air sealing protocols.

*Blow-down:* The act of removing water from a boiler to remove sediment and suspended particles from the boiler water.

*Blower:* A squirrel-cage fan in a furnace or air handler.

*Blown insulation :* A loose-fill insulation that is blown into attics and building cavities using an insulation blowing machine.

*Board foot:* An American measurement of lumber volume. A board foot equals 144 cubic inches of wood, or 12”x12”x1”.

*Boiler:* A fossil fuel appliance used for producing hot water or steam as the medium to distribute heat to the dwelling unit.

*Boot:* A duct section that connects between a duct and a register or between round and square ducts

*Bonus room:* A room that is substandard in some way and not listed in a home’s salable features.

*Borescope:* A flexible tube with a light and camera or viewer at one end. Inspectors use borescopes to look into wall cavities and other tight spaces, otherwise impossible to inspect.

*Boundary:* Defines where one area ends and another begins.

*Branch circuit:* An electrical circuit used to power receptacles and lights within a home.

*Branch duct:* An air duct which branches from a main duct.

*Brightness:* The intensity of the sensation derived from viewing a lit surface. Measured in footlamberts or candelas per square meters. It is also called luminance or luminous intensity.

*British thermal unit (Btu):* The quantity of heat required to raise the temperature of one pound of water one degree Fahrenheit.

*BTUh :* British Thermal Units per hour.

*Building cavities:* The spaces inside walls, floors, and ceilings between the interior and exterior sheathing

*Building envelope:* The area of the building that encloses its conditioned and unconditioned spaces.

*Building Performance Institute (BPI):* Organization supporting the development of a highly professional building performance industry through individual and organizational credentialing and a quality assurance program.

*Building science:* A complex perspective on buildings, using contemporary technology to analyze and solve problems of design, construction, maintenance, safety, and energy efficiency.

*Building shell:* Separates a building's indoors from the outdoors.

*Bulk moisture:* Large amounts of water intrusion, for example from wind-driven rain or sub-surface water.

*Burner:* A device that facilitates the burning of a fossil fuel, like gas or oil.

*Butyl-backed tape:* Heavy-duty, pressure-sensitive sealant or gasket.

*Bypass:* An air leakage site that allows air to leak into or out of a building flowing around the air barrier and insulation.

*Cad cell:* A flame sensor composed of the chemical compound cadmium sulfide. Its purpose is to sense whether a flame is present during a burner cycle. If the cad cell doesn't detect a flame, it shuts the burner off.

*Calibration:* Comparison of the test results of an instrument to a known reference point.

*Call-back:* Having a weatherization team return to a job site to perform work not done or to redo work done unsatisfactorily.

*Can light:* A light fixture (or can) that is set into the ceiling. Also called a recessed light fixture.

*Cantilever:* A projecting structure, such as a beam, that is supported at one end and carries a load at the other end or along its length.

*Cantilevered floor*: A floor that extends beyond the foundation of the framed structure below it.

*Cape Cod*: A house design featuring a finished attic space, also called a one-and-a-half story.

*Capillary action*: The ability of water to move through materials, even upward against gravity, through small tubes or spaces.

*Capillary barrier*: A material or air space designed to stop capillary action from carrying water into a building.

*Carbon dioxide (CO<sub>2</sub>)*: A heavy, colorless, nonflammable gas formed by the oxidation of carbon, by combustion, and by the respiration of plants and animals. One of two main products of complete combustion of a hydrocarbon (the other is water vapor).

*Carbon monoxide (CO)*: Carbon monoxide is a tasteless, odorless, colorless and poisonous gas that is a by-product of incomplete combustion of fossil fuels. It is usually caused by a lack of air to support combustion or impingement of the flame.

*Carcinogen*: A material known to cause cancer.

*Casement window*: Casement windows have a single operable hopper style sash that swings upward horizontally, or more commonly that swings outward on a vertical plane. Casement window frames that have gone out of square due to settling can stick and quite possibly render these types of windows inoperable.

*Casing*: Decorative molding or trim around a window or door.

*Cathedral ceiling*: A sloped ceiling insulated between the roof deck and the finish ceiling material.

*Cathedralized attic*: An attic that is insulated at the underside of the roof deck rather than at the ceiling.

*Caulking*: Mastic compound for filling joints and cracks.

*Celsius (°C)*: The metric temperature scale used in Europe and most other countries. Water freezes at 0°C and boils at 100°C.

*Cellulose insulation*: Insulation, packaged in bags for blowing, made from newspaper or wood waste and treated with a fire retardant.

*Centigrade*: Another word for Celsius (°C)

*Central heating system*: The primary heating system of the dwelling unit including the heat producing appliance along with the return and supply system for heat distribution.

*Certification*: Recognition by an independent person or group that someone can competently complete a job or task, frequently demonstrated by passing an exam.

*Certified renovator*: A person authorized by the EPA to perform repair and renovation projects that disturb lead-based paint.

*CFM<sub>50</sub>*: The amount of cubic feet per minute of air moving through a structure. Measured at 50-pascals pressure during a blower-door test.

*CFM<sub>n</sub>*: The amount of cubic feet of air moving through a structure under typical, natural conditions.

*CFM - Cubic feet per minute*: An American measurement of air-flow equal to 0.472 liters per second.

*Chaseway*: Cavity within a building with a purpose of conveying pipes, ducts, etc. through the building. Chaseways, such as plumbing walls, are common sites for air leakage.

*Chimney*: A building component designed for the sole purpose of assuring combustion by-products are exhausted to the exterior of the building.

*Chimney connector*: A pipe that connects a fuel-burning appliance to a chimney. Also see *vent connector*.

*Chimney flue*: A passageway in a chimney for conveying combustion gases to the outdoors.

*Chimney chase*: The framing and other building materials that surround the chimney.



*Circuit breaker:* A device found in a Circuit Panel Box that completes an electrical circuit. This breaker disconnects the circuit from electricity when it senses an overload of current.

*Cladding:* The exterior covering or coating on a structure, such as wood siding, stucco, or brick veneer.

*Clean and tune (C&T):* A procedure performed on a heating or cooling system by a qualified technician to optimize its efficiency.

*Cleanout:* An opening in a chimney (usually at its base) to allow inspection and the removal of ash or debris.

*Clearances:* Allowable distances between heat-producing appliances, chimneys, or vent systems and combustible surfaces.

*Climate zone:* An area with a prevailing climate that distinguishes it from other areas by parameters such as temperature, rainfall, and humidity.

*Codes:* Any set of standards set forth and enforced for the protection of public health and building durability.

*Co-efficient of performance (COP):* A dimensionless number representing the ratio of a heat pump or air conditioner's output in watt-hours of heat moved divided by watt-hours of electrical input.

*Coil:* A snake-like piece of copper tubing surrounded by rows of aluminum fins that clamp tightly to the tubing and aid in heat transfer.

*Coil stock:* Sheet metal packaged as a coil in various widths.

*Cold-air return:* Ductwork that draws house air into the air handler for reheating by a furnace.

*Cold roof:* A roof design where the roof temperature is equalized from top to bottom by roof ventilation and/or roof insulation to prevent ice damming.

*Collar beam:* A horizontal piece in roof framing that provides structural strength by connecting opposite rafters.

*Color rendering index (CRI):* A measurement of a light source's ability to render colors the same as sunlight. CRI has a scale of 0 to 100.

*Color temperature:* A measurement of the warmness (redness or yellowness) or coolness (blueness or whiteness) of a light source in the Kelvin temperature scale.

*Column:* A vertical building support usually made of wood or steel.

*Combustible:* Means something will burn, although not necessarily readily.

*Combustible gas leak detector:* A device for determining the presence and general location of combustible gases in the air.

*Combustion:* The act or process of burning. Oxygen, fuel, and a spark must be present for combustion to occur.

*Combustion air:* Air that chemically combines with a fuel during the combustion process to produce heat and combustion gases, mainly carbon dioxide and water vapor.

*Combustion analyzer:* A device used to measure and analyze combustion gases for efficiency and safety.

*Combustion appliance:* Any appliance in which combustion occurs.

*Combustion appliance zone (CAZ):* The closed space or area that holds one or more combustion appliances.

*Combustion appliance zone (CAZ) testing:* Diagnostics performed to ensure that combustion appliances work properly and that house pressures allow combustion gases to vent.

*Combustion byproducts:* Gases, vapors, and particulates produced whenever carbon-based fuels are burned.

*Combustion chamber:* The area inside the *heat exchanger* where the flame burns.

*Combustion efficiency:* Synonymous with *steady-state efficiency*.

*Combustion gases:* Combustion byproducts.

*Commissioning:* The process of testing and adjusting building mechanical systems.

*Common vent :* The portion of the vent or chimney that the combustion products of multiple appliances pass through.

*Compact fluorescent lamp (CFL):* A small fluorescent light engineered to fit in an Edison base of an incandescent fixture.

*Compartmentalization:* Air sealing that prevents air from migrating from one dwelling or zone of a multifamily building to another.

*Competency:* Demonstrated ability to perform a job or task.

*Compressor:* A motorized pump that compresses the gaseous refrigerant and sends it to the condenser where heat is released.

*Concentrically constructed direct-vent:* A direct-vent appliance that has an exhaust-gas vent and a combustion-supply-air vent arranged in a concentric fashion: one pipe is inside the other with a space between the walls of each.

*Condensate:* Vapor condensed back to a liquid. For example: water or refrigerant.

*Condensate receiver:* A tank for catching returning condensate water from a steam heating system or condensed refrigerant from a condenser.

*Condense:* When a gas turns into a liquid as it cools, it condenses. When a gas condenses into a liquid it releases heat.

*Condenser:* The coil in a refrigeration system where the refrigerant condenses and releases heat.

*Condensing furnace:* A high-efficiency furnace that removes latent heat from combustion gases by condensing water vapor out of the combustion gases.

*Conditioned:* Intentionally heated or cooled areas of a building.

*Conditioned air:* Air that has been heated, cooled, humidified, or dehumidified to provide comfort.

*Conditioned space:* For energy purposes, space within a building that is provided with heating and/or cooling equipment or systems, or that communicates directly with a conditioned space. For mechanical purposes, an area, room or space being heated or cooled by any equipment or appliance.

*Conductance:* The quantity of heat, in BTUs, that flows through one square foot of material in one hour, when there is a one degree Fahrenheit temperature difference between both surfaces. Conductance values are given for a specific thickness of material.

*Conduction:* Conduction is the transfer of heat through a material by molecular vibration.

*Conductivity:* The quantity of heat that flows through one square foot of homogeneous material, one inch thick, in one hour, when there is a temperature difference of one degree Fahrenheit between its surfaces.

*Confined space:* A space, defined for the purpose of evaluating combustion air, with a volume of less than 50 cubic feet per 1,000 BTU per hour of the total input rating of all combustion appliances installed in that space.

*Contractor:* Any person or entity that provides services under contract, and not as employees of the purchasing agency.

*Contrast:* Difference in brightness measured by the relationship between an object's brightness and the brightness of its background.

*Control circuit:* An electrical circuit that activates or deactivates a power circuit or opens and shuts a valve.

*Convection:* The transfer of heat caused by the movement of a fluid like water or air. When a fluid becomes warmer it becomes lighter and rises.

*Convective loop:* Heat flow resulting from fluid flow between surfaces of different temperatures.

*Cooling load:* The maximum rate of heat removal required of an air conditioner when the outdoor temperature and humidity are at a standard worst-case outdoor condition.

*Core competencies:* Essential skills for weatherization workers, defined by the Weatherization Trainers Consortium.

*Cost effective:* Having an acceptable payback, return-on-investment, or savings-to-investment ratio.

*Crawl space:* The low space beneath the ground floor of a building that gives workers access to wiring and plumbing.

*Crew leader:* A crew leader is a residential energy professional who supervises weatherization tasks specified in the scope of work.

*Critical framing juncture:* An intersection of framing members and envelope components that require special attention during air sealing and insulation.

*Cross section:* A view of a building component drawn or imagined by cutting through the component.

*Crosswise floor-joists:* Mobile home joist configuration where the main duct is located beneath the floor joists and connected by boots to the sub-floor.

*Cubic foot per minute (CFM):* A measurement of volumetric air-flow rate. See also *CFM<sub>50</sub>* and *CFMn*.

*Curtain wall:* A wall between *columns* and *beams* that supports no weight but its own.

*Dado:* A rectangular groove cut into wood to create a structural joint.

*Decatherm:* One million BTUs or 10 therms.

*Decking:* The wood material structural sheathing installed over the *rafters* to support the roofing.

*Decommissioning:* Removing or retiring equipment from active service including disposing of hazardous material in an approved way.

*Deferral of services:* Postponement or denial of weatherization services to the client.

*Dehumidification:* The removal of water from the air. Excess humidity can cause mold.

*Degree days (DD):* A cumulative measurement of outdoor temperature calculated by adding the temperature differences between an indoor temperature of 65°F and the daily average outdoor temperature for a one-year period.

*Delta-T:* Temperature difference.

*Demand:* The peak need for electrical energy. Some utilities levy a monthly charge for demand.

*Demand-side management (DSM):* The planning and implementation of utility-sponsored conservation of electricity or gas.

*Dense packing:* Blowing insulation with sufficient force to create a high density to reduce settling and minimize air leakage and air convection.

*Density:* The weight of a material divided by its volume, usually measured in pounds per cubic foot.

*Depressurization tightness limit (DTL):* A calculation procedure, expressed in units of CFM<sub>50</sub>, performed to estimate the building tightness level at which combustion appliances might backdraft when the house is under conditions of worst-case depressurization. The DTL sets a low limit for air sealing that may or may not be lower than the *BTL* for the same house.

*Depressurize:* Cause to have a lower pressure or higher vacuum with respect to a pressure reference point such as the outdoors.

*Desiccant:* A liquid or solid material used to absorb water or water vapor.

*Design temperature:* A high or low temperature, based on climate history, used for designing heating and cooling systems when calculating heating and cooling loads.

*Desk monitoring:* Weatherization monitoring activities performed through review of paperwork.

*De-superheater:* A heat exchanger that removes the superheat from a compressed refrigerant and transfers that heat to another fluid, usually water.

*Dew point:* The warmest temperature of an object in an environment where water condensation from the surrounding air would form on that object.

*Diffusion:* Movement of water vapor through a material as a function of the *vapor pressure* across a material and the vapor permeability of that material. See also: *vapor permeable*

*Dilution air:* Air that enters through the dilution device—an opening where the chimney joins to an atmospheric-draft combustion appliance

*Dilution device:* A draft diverter, draft hood, or barometric draft control between an atmospheric-draft combustion appliance and its chimney.

*Direct current:* An electric current flowing in only one direction.

*Direct leakage:* Air enters and exits at same location; occurs at direct openings to outdoors.

*Direct-vent appliance:* A combustion appliance for which all combustion gases are vented to the outdoors through an exhaust vent pipe and all combustion supply air is supplied to the combustion chamber from the outdoors through a separate, dedicated supply-air pipe. See also *sealed-combustion*

*Discount rate:* The interest rate at which expected future cash savings can be discounted for the time value of money.

*Distribution system:* A system of wires, pipes, or ducts that distributes energy.

*DOE:* The United States Department of Energy.

*Domestic hot water (DHW):* Refers to a separate, closed system to heat potable (drinkable) water and supply it to the dwelling unit for washing, bathing, etc.

*Dominant duct leakage:* To identify either dominant supply or return leaks in a forced-air distribution system by measuring house pressure.

*Door casing:* A wooden trim around doors that covers the seam between the jamb and the wall.

*Door stop:* The wood trim fastened to the inside of the door jamb that stops the door's swing.

*Dose:* The amount of pollutant that enters a human body, exposed to the pollutant.

*Dormer:* A framed structure projecting above a sloping roof surface, and normally containing a vertical window.

*Double-hung window:* Double-hung windows have operable upper and lower sashes that slide vertically in a channel.

*Downflow:* Airflow configuration in a furnace where air flows from above the air handler and discharges from the bottom.

*Downflow furnace:* Furnace type where the blower is located at the top of the furnace cabinet and air is forced downwards across the heat exchanger and into the ducts located in below the furnace.

*Downstream:* Away from the source of the flow.

*Draft:* A pressure difference that causes combustion gases or air to move through a vent connector, flue, chimney, or combustion chamber.

*Draft diverter:* A device located in gas appliance flue pipe. Used to moderate or divert draft that could extinguish the pilot or interfere with combustion.



*Draft fan:* A mechanical fan used in a venting system to augment the natural draft in gas- and oil-fired appliances. These electrically operated, paddle-fan devices are installed in furnaces.

*Draft gauge:* Device for testing chimney draft.

*Draft hood:* See draft diverter.

*Draft inducer:* A fan that depressurizes the combustion chamber or venting system to move combustion products toward the outdoors.

*Draft regulator:* A self-regulating damper attached to a chimney or vent connector for the purpose of controlling draft.

*Drainage plane:* A space that allows water storage and drainage in a wall cavity, adjacent to or part of the *water-resistive barrier*.

*Dropped-down belly:* Mobile home configuration where a hump is formed in the floor by the rodent barrier and insulation going around the main duct attached to the floor's bottom.

*Dropped soffit:* A lowered part of the ceiling in a home.

*Drywall:* Gypsum interior wallboard used to produce a smooth and level interior wall surface and to resist fire. Also called gypsum wall board or sheetrock.

*Dry-bulb temperature:* Normal ambient air temperature measured by a thermometer.

*Duct blower:* A blower-door-like device used for testing duct leakiness and airflow.

*Duct board:* Rigid board composed of insulation material with one or both sides faced with a finishing material, usually aluminum foil.

*Duct boot:* Transition piece that connects the main duct to the floor and is often vulnerable to failure.

*Duct-induced pressure differences:* Pressure differences between rooms in a building caused by the ducted air delivery system, can be due to supply ducts, return ducts, or both.

*Duplex:* Any structure which consists of two separate dwelling units in one building.

*Dwelling unit:* A house, including a stationary mobile home, an apartment, a group of rooms, or a single room occupied as separate living quarters.

*Eave:* The part of a roof that projects beyond its supporting walls (See - *Soffit*).

*Eave chute:* Device that maintains air space between the insulation blanket and the roof sheathing and prevents insulation from clogging eave vents.

*Eave vent:* Vent opening located in the soffit under the eaves of a house to allow the passage of air through the attic and out the roof vents.

*Economizer:* A subsystem in an HVAC system that saves energy by using favorable outdoor temperature and humidity to condition building air.

*Efficiency:* The ratio of output divided by input.

*Efficacy:* The number of lumens produced by a watt used for lighting a lamp. Used to describe lighting efficiency. Synonym: Effectiveness.

*Egress window:* A window with a defined opening size for the purpose of fire escape.

*Elastomeric:* A characteristic of a material that is flexible and permits joint movement.

*Elastomeric coating:* Polymeric material, such as acrylic, that is used to coat roof leaks and to reduce solar heat gain.

*Electrical load:* Term for the wattage drawn by an electrical device or the device itself.

*Electric service:* The electric meter and main switch, usually located outside the building.

*Electro-mechanical:* Describes controls where an automatic mechanical device like a bimetal or bulb-and-bellows does the switching.

*Emergency heat:* 1. A heating device that doesn't require electricity used during an emergency. 2. Or electric-resistance heating elements used for heating in case a heat pump's compressor fails.

*Emittance:* The rate that a material emits radiant energy from its surface. Also called emissivity.

*Encapsulation:* Any covering or coating that acts as a barrier between the hazard, such as lead-based paint, and the indoor environment.

*Enclosure:* The building shell or building envelope. The exterior walls, floor, and roof assembly of a building.

*Energy:* A quantity of heat or work

*Energy audit:* The process of identifying energy conservation opportunities in buildings.

*Energy auditor:* One who inspects and surveys the energy use of buildings in order to promote energy conservation.

*Energy conservation measures (ECM):* Building components or products installed to reduce the building's energy consumption.

*Energy consumption:* The conversion or transformation of potential energy into kinetic energy for heat, light, electricity, etc.

*Energy education:* Communication used by weatherization staff to inform clients of ways to reduce energy consumption by altering their behavior.

*Energy efficiency:* Term used to describe how efficiently a building component uses energy.

*Energy efficiency ratio (EER):* A measurement of energy efficiency for room air conditioners. The EER is computed by dividing cooling capacity, measured in British Thermal Units per hour (Btuh), by the watts of electrical power. (See - *Seasonal Energy Efficiency Rating* or SEER)

*Energy factor:* The fraction of water heater input remaining in 64 gallons per day of hot water flowing from a water heater.

*Energy Information Administration (EIA):* Section of the U.S. Department of Energy providing statistics, data, and analysis on resources, supply, production, and consumption for all energy sources.

*Energy rater:* A person who evaluates the energy efficiency of a home and assigns a performance score, a certification received from HERS (Home Energy Rating System).

*Energy-recovery ventilator (ERV):* A ventilator that recovers latent and sensible energy from the exhaust airstream and imparts it to the incoming airstream.

*Enthalpy:* The internal heat of a material measured in Btus per pound.

*Entropy:* Heat unavailable to a closed thermodynamic system during a heat transfer process.

*Envelope:* The building shell. The exterior walls, floor, and roof assembly of a building. Also referred to as the enclosure.

*Environmentally sensitive:* Highly susceptible to adverse effects of pollutants.

*EPA, U.S. Environmental Protection Agency:* EPA protects human health and safeguards the natural environment.

*Equivalent length:* The length of straight pipe or duct that has equivalent resistance to a pipe fitting or duct fitting. Used for piping and duct design.

*Equivalent duct length (EDL):* A measure of how much static pressure a fan has to overcome.

*Equivalent leakage area (ELA):* Calculation, in square inches, of the total area of all holes and cracks in a structure. The leakage area is then combined to represent one total leakage area.

*Evaporation:* The change of a liquid to a gas. Evaporation is the key process in the operation of air conditioners and evaporative coolers. Evaporation absorbs heat.

*Evaporative cooler:* A device for cooling homes in dry climates by reducing the temperature of incoming air by the evaporation of water.

*Evaporator:* The heat transfer coil of an air conditioner or heat pump that cools the passing air as the refrigerant inside the coil evaporates and absorbs the air's heat.

*Excess air:* Air in excess of what is needed for combustion.

*Exfiltration:* The movement of air out of a building.

*Expanded polystyrene:* White polystyrene insulation.

*Expanding foam:* An insulation product designed to expand and harden upon contact with the air. Available in canisters with spray nozzles that make it easy to apply foam in a wide variety of situations.

*Expansion valve:* A valve that meters refrigerant into the evaporator.

*Exposure:* A specific assessment of pollutant amount and duration that a human is exposed to.

*Fahrenheit:* A temperature scale used in the United States and a few other countries. On the Fahrenheit scale, water boils at 212 degrees and freezes at 32 degrees.

*Fan-assisted combustion:* A combustion appliance with an integral fan to draw combustion supply air through the combustion chamber.

*Fan control:* A bimetal thermostat that turns the furnace blower on and off as it senses the presence of heat.

*Fan-off temperature:* In a furnace, the supply-air temperature at which the fan control shuts down the blower fan.

*Fan-on temperature:* In a furnace, the supply air temperature at which the fan control activates the blower fan.

*Federal Energy Management Program (FEMP):* A program of DOE that implements energy legislation and presidential directives. FEMP provides project financing, technical guidance and assistance, coordination and reporting, and new initiatives for the federal government.

*Feeder wires:* The wires connecting the electric meter and main switch with the main panel box indoors.

*Fenestration:* Window and door openings in a building's wall.

*Fiberglass:* A fibrous material made by spinning molten glass used as an insulator and heat loss retardant.

*Field testing:* Evaluation of a trainee's abilities conducted on-site, rather than in a classroom.

*Fill tube:* A plastic or metal tube used to blow insulation inside a building cavity.

*Fin comb:* A comb-like tool used to straighten bent fins in air conditioning and heat-pump coils.

*Final inspection:* An evaluation of a weatherization job at or after its completion.

*Finished attic:* An attic that was converted to living space by the construction of dormers and knee walls.

*Finned tube:* A length or coil of pipe with heat transfer fins attached for heat transfer.

*Fire barrier:* A fire-resistance-rated building assembly, designed to contain a fire for a particular time period.

*Fire blocking:* Building materials installed to resist the free passage of flames and smoke, to adjacent areas of the building.

*Fire resistance:* The property of building materials or assemblies that prevents or retards the passage of heat, hot gases, or flames during a fire.

*Fire resistance rating:* The period of time a building element, component or assembly maintains the ability to confine a fire, continues to perform a given structural function, or both.

*Fire stop:* Framing member designed to stop the spread of fire within a wall cavity.

*Fire tape:* Tape and drywall-finishing compound applied to create a fire-resistant assembly.

*Firewall:* A fire-resistance-rated smoke-tight wall with protected openings that restricts the spread of fire. A firewall extends continuously from the foundation to or through the roof. The firewall is designed to remain standing even if the assemblies on either side collapse during a fire.

*Flame impingement:* The contact of flame against an object, such as a metal heat exchanger.

*Flame rectification:* A modern method of flame sensing that uses the flame itself as a conductor in the flame-safety circuit.

*Flame-retention head burner:* A high efficiency oil burner that produces a hotter flame and operates with a lower airflow, compared to older oil burners.

*Flame roll-out:* Fuel gas combustion process occurring outside the normal combustion area of a combustion appliance.

*Flame safety control:* A control device used to stop the flow of fuel to the burner if the fuel doesn't ignite.

*Flame spread:* A fire rating for materials in a fire test that compares the spread of flame to red oak, which has a flame spread of 100.

*Flammability:* The rating for building materials that will burn readily when exposed to a flame.

*Flammable:* Combustible; readily set on fire.

*Flashing:* Waterproof material used to prevent leakage at intersections between building assemblies or penetrations through the building envelope.

*Floor joists:* The framing members that support the floor.

*Flue:* The channel or pipe that conveys combustion gases.

*Flue gas:* Combustion gases, mainly carbon dioxide, water vapor, nitrogen, and oxygen.

*Flush flange:* A window frame designed to provide a finished exterior appearance over a flat exterior surface like stucco.

*Foam board:* Plastic foam insulation manufactured most commonly in sheets.

*Foam compatible adhesive:* Adhesive that is manufactured to safely adhere foam to itself and other materials.

*Foot candle:* A measure of light striking a surface.

*Footing:* The part of a foundation system that actually transfers the weight of the building to the ground.

*Forced draft:* A vent system for which a fan installed at the combustion appliance moves combustion gases to the outdoors with positive static pressure in the vent pipe. Because of this positive pressure, the vent connector must be air-tight.

*Fouling:* The deposit of particles and fluids on a heat exchanger or other HVAC component.

*Friable:* Easily broken into small fragments or reduced to powder, as with asbestos.

*Frost line:* The maximum depth of the soil where water will freeze during the coldest weather.

*Fuel escalation rate:* Annual escalation rate of fuel prices based on the annual energy price forecasts of DOE's Energy Information Administration.

*Furnace:* An appliance that produces and distributes warm air throughout the dwelling unit.



*Furring*: Thin wood strips fastened to a wall or ceiling surface as a nailing base for finish materials.

*Fuse*: A current carrying element that melts if too much current flows in an electric circuit.

*Gable*: The triangular section of an end wall formed by the pitch of the roof.

*Gable roof*: A roof shape that has a ridge at the center and slopes in two directions.

*Gable vent*: A screened vent installed at or near the peak of a roof gable that allows air exchange between the attic and outdoors.

*Gallons per minute (GPM)*: The unit for measuring water flow in a supply pipe or heat-distribution pipe or oil flow in a burner.

*Gasket*: Elastic strip that seals a joint between two materials.

*General heat waste*: Pertaining to general weatherization materials that DOE believes are cost-effective.

*Glare*: Any bright light or light reflection that annoys, distracts, or reduces visibility.

*Glass load factor*: A number combining glass's solar heat transmission and its heat conduction. Used for cooling load calculations.

*Glazing*: Pertaining to glass assemblies, installation or windows.

*Glazing compound*: A flexible, putty-like material used to seal glass in its sash or frame.

*Grade*: The level of the ground around a building.

*Grantee*: The individual or organization that receives a grant.

*Gravity furnace*: A central heating system that uses natural gravity to distribute heated air or water throughout the dwelling unit as opposed to forced circulation, using pumps or blowers.

*Ground fault circuit interrupter (GFI or GFCI):* An electrical connection device that breaks a circuit if current flows in a grounding wire.

*Ground-moisture barrier:* A plastic material covering the ground that is both a vapor barrier and a water barrier, which protects building materials from excessive relative humidity.

*Gusset:* A metal or wood plate added to the surface of a joint to strengthen the connection.

*Gypsum board:* A common interior sheeting material for walls and ceilings made of gypsum rock powder packaged between two sheets of heavy building paper. Also called drywall, sheet-rock, gyprock, or gypboard.

*Habitable space:* A building space intended for continual human occupancy. Examples include areas used for sleeping, dining, and cooking, but not bathrooms, toilets, hallways, storage areas, closets, or utility rooms. See occupiable space and conditioned space.

*Hallway return or hallway return system:* A type of mobile home air distribution system. The mobile home heating or cooling system receives return air through a central trunk line beneath the hallway.

*Hatch:* A rectangular hole in a horizontal building assembly like a floor or ceiling that allows access

*Hazardous Material:* A particular substance that is considered a danger to the client or crew.

*Head:* Foot pounds of mechanical energy per pound of fluid created by a pump to overcome gravity or friction.

*Head jamb:* Groove at the top of the window that allows the window sashes to slide into place and sit inside the window frame.

*Health and safety (H&S):* Provision included in a 1976 law change for the Weatherization Assistance Program. WAP now

considers the health and safety of low-income families, as well as reducing their energy costs.

*Heat:* Molecular movement

*Heat anticipator:* A device in a thermostat that causes the thermostat to turn off before room temperature reaches the thermostat setting, so that the house doesn't overheat from heat remaining in the heater and distribution system after the burner shuts off.

*Heat capacity:* The quantity of heat required to raise the temperature of 1 cubic foot of a material 1 degree F.

*Heat exchanger:* The device in a heating unit that separates the combustion chamber from the distribution medium and transfers heat from the combustion process to the distribution medium.

*Heat gains:* Term used to mean unwanted heat that accumulates in homes, making mechanical cooling desirable or necessary.

*Heat loss:* The amount of heat escaping through the building shell as measured for a specific period of time (month, year, etc.)

*Heat pump:* A type of heating/cooling unit, usually electric, that uses a refrigeration system to heat and cool a dwelling.

*Heat-recovery ventilator:* A central ventilator that transfers heat from exhaust to intake air.

*Heat transmission:* Heat flow through the walls, floor, and ceiling of a building, not including air leakage.

*Heat transfer coefficient:* See U-factor.

*Heating degree day(s) (HDD):* See: Degree days

*Heating load:* The maximum rate of heat conversion needed by a building during the coldest weather.

*Heating seasonal performance factor (HSPF):* Rating for heat pumps describing how many Btus of heat they transfer per watt-hour of electricity they consume.

*High-efficiency particulate air (HEPA) vacuum:* A vacuum cleaner that uses a high-efficiency particulate air (HEPA) filter.

*High limit:* A thermostat that turns the heating element of a furnace or boiler off if it senses a dangerously high temperature.

*Hinges:* The metal objects that attach a door to a door jamb, normally with screws.

*Hip roof:* A roof with two or more adjacent roof surfaces, joined along a sloping “hip.”

*Home energy index:* The number of BTUs or kWh of energy used by a home, divided by its area of conditioned square feet.

*Home energy rating systems (HERS):* A nationally recognized energy rating program that give builders, mortgage lenders, secondary lending markets, homeowners, sellers, and buyers a precise evaluation of energy losing deficiencies in homes.

*Home heating index:* The number of Btus of energy used by a home divided by its area in square feet, then divided by the number of heating degree days during the time period.

*HOME Program:* A program created under Title II (the Home Investment Partnership Act) of the National Affordable Housing Act of 1990. Provides funds for states to expand the supply of decent and affordable housing for low-income people.

*Home Ventilating Institute (HVI):* A non-profit association of manufacturers of residential ventilating products offering a variety of services including testing, certification, verification, and marketing programs.

*Hot roof:* An unventilated roof with insufficient insulation to prevent snow melting on the roof and the creation of ice dams.

*House as a system:* The concept that many components of a house interact, affecting the home’s comfort and performance.

*House depressurization limit:* A selected indoor negative pressure; expressed in Pascals, immediately around vented combustion appliances that use indoor air for combustion supply air.

*House pressure:* The difference in pressure between the indoors and outdoors measured by a manometer.

*House wrap:* A generic term for the modern version of the building's water-resistive barrier.

*HUD:* U.S. Department of Urban Housing and Development

*Humidistat:* An automatic control that switches a fan, humidifier, or dehumidifier on and off to control relative humidity.

*Humidity ratio:* Same as "absolute humidity." The absolute amount of air's humidity measured in pounds or grains of water vapor per pound of dry air.

*HVAC:* Heating, ventilation, and air-conditioning system. All components of the appliances used to condition a building's indoor air.

*Hydronic system:* A heating system that uses hot water or steam as the heat-transfer fluid. Commonly called a hot-water heating system.

*Hygrometer:* A tool for measuring relative humidity. A psychrometer, which uses two thermometers, one with a dry bulb and one with a wet bulb, is a simple hygrometer.

*IAQ:* Indoor Air Quality. The quality of indoor air relative to its acceptability for healthful human habitation.

*I-beam:* A rolled or extruded metal beam having a cross section resembling a capital I.

*IC rated:* Insulation Contact rating for light fixtures. IC housings may be in direct contact with fibrous insulation.

*Ice dam:* Ice that forms at the roof eaves during differential temperatures of a roof deck causing freezing and thawing.

*IECC:* International Energy Conservation Code

*Ignition barrier:* A material installed to prevent another material, often plastic foam, from catching fire.

*Illumination:* The light level measured on a horizontal plane in Foot Candles.

*Inaccessible cavity:* An area that is too confined to enter and/or maneuver in by an average worker.

*Incandescent light:* The common light bulb found in residential lamps and light fixtures and known for its inefficiency.

*Inches of Water Column (IWC):* A non-metric unit of pressure difference. One IWC equals about 250 Pascals.

*Incidental repairs:* Under DOE rules, this term refers to the repairs on a dwelling unit to protect the performance and durability of *energy conservation measures*.

*Indirect leakage:* Describes how air leaks into the home at one point and out at a different point. Indirect leakage is more difficult to discover compared to direct leakage. Indirect leakage occurs through a dwelling's *bypasses* or *chaseways*.

*Indoor air quality (IAQ):* The quality of indoor air relative to its acceptability for healthful human habitation.

*Induced draft:* A vent system or combustion appliance for which a fan, installed at or very near the termination point of the appliance or the vent pipe, moves the combustion gases.

*Infiltration:* Infiltration refers to the movement of air into a building through cracks and penetrations in the building envelope.

*Infrared:* Pertaining to heat rays emitted by the sun or warm objects on earth.

*Infrared camera:* A special camera that “sees” temperature differences on surfaces, allowing the user to determine if a building assembly is insulated properly. This instrument is also useful for detecting air leakage if used with a blower door.

*Infrared thermography:* The science of using infrared imagers to detect radiant energy on building surfaces, which visualizes a building's heat loss.

*Input rating:* The measured or assumed rate at which an energy-using device consumes electricity or fossil fuel.

*Insolation:* The amount of solar radiation striking a surface.

*Inspector:* A weatherization worker responsible for quality control or quality assurance by making final inspections and in-progress inspections.

*Inspection gap:* A gap in foundation insulation left for the purpose of inspecting for insect infestation.

*Instantaneous water heater:* A water heater with no storage tank that heats water instantaneously as the water flows through it.

*Insulated flex duct:* A round duct composed of two flexible plastic tubes with tubular insulation and air barrier between the two.

*Insulated glass:* Two or more glass panes spaced apart and sealed in a factory.

*Insulated glass unit (IGU):* Two or more glass panes spaced apart and sealed in a factory.

*Insulation:* A material used to resist heat transmission.

*Insulation dam:* A material that prevents fibrous insulation from flowing into an area where it isn't necessary or wanted.

*Insulation restrainer:* A flexible material, such as netting or fabric, used to hold blown fibrous insulation in place.

*Insulation shield:* A fire-barrier erected around a heat producing device to prevent insulation from covering or contacting hot surfaces.

*Intentionally conditioned:* Conditioned by design and fitted with radiators, registers, or other devices to maintain a comfortable temperature.

*Intermediate zone:* A zone located between the building's conditioned space and the outdoors, like a crawl space or attic.

*Intermittent ignition device (IID):* A device that lights the burner on a gas appliance when the control system calls for heat, thus saving the energy wasted by a pilot light.

*Internal gains:* The heat generated by bathing, cooking, and operating appliances, that must be removed during the summer to promote comfort.

*International Association of Plumbing and Mechanical Officials (IAPMO):* The industry trade group that develops the Uniform Mechanical Code and the Uniform Plumbing Code.

*International Codes Council (ICC):* An international non-governmental organization for developing building safety, fire prevention, and energy efficiency codes (I-codes).

*International Fuel Gas Code (IFGC):* Code that addresses the design and installation of fuel gas systems and gas-fired appliances through requirements that emphasize performance.

*International Residential Code (IRC):* The most prominent building code in the US managed by the *International Codes Council*.

*Interstitial space:* Building cavity. Space between framing and other building components.

*Intrusion:* Air moving into and out of insulation without going through the wall or ceiling assembly.

*Jalousie windows:* A type of window usually associated with mobile homes with two or more panes of glass that pivot on a horizontal axis.

*Jamb:* The side or top piece of a window or door frame.

*Jamb clips or plates:* Structural devices used to fasten a block-frame window to its opening.

*Job task analysis:* A prioritized list of knowledge, skills, and abilities derived from analysis of a job.

*Joist:* A horizontal wood framing member that supports a floor or ceiling.



*Joule*: A unit of energy. One thousand joules equals 1 BTU.

*Kerf*: A slit made by cutting, often with a saw.

*Kilowatt*: A unit of electric power equal to 1000 joules per second or 3412 Btus per hour.

*Kilowatt-hour*: The most commonly used unit for measuring the amount of electricity consumed over time; one kilowatt of electricity supplied for one hour. A unit of electric energy equal to 3600 kilojoules.

*Knee wall*: A short wall, often less than three feet in height. Knee walls are common in old houses with finished attic spaces.

*Knee-wall attic*: An triangular attic with short walls, usually under three feet in height.

*Knob-and-tube wiring*: Early standardized electrical wiring in homes consisting of insulated copper conductors supported by porcelain knobs and tubes.

*Lamp*: A light bulb.

*Latent heat*: The amount of heat energy required to change the state of a substance between a solid and a liquid, or from a liquid to a gas.

*Lath*: A support for plaster, consisting of thin strips of wood, metal mesh, or gypsum board.

*Lawrence Berkeley National Laboratory (LBNL)*: Member of the national laboratory system supported by DOE through its Office of Science. LBNL conducts research on building energy efficiency.

*Lead RRP Program (RRP)*: Firms that work on projects that disturb lead-based paint in homes, child care facilities and pre-schools built before 1978 must have their firm certified by EPA (or an EPA authorized state), use certified renovators who are trained by EPA-approved training providers and follow lead-safe work practices.

*Leadership in Energy and Environmental Design (LEED):* A building certification system developed by the U.S. Green Building Council.

*Leakage ratio:* Measurement of total square inches of air leakage area per 100 feet of building envelope surface area.

*Light quality:* The relative presence or absence of glare and brightness contrast. Good light quality has no glare and low brightness contrast.

*Local ventilation:* Ventilation at the source of building pollutants, also called *spot ventilation*. For example: kitchen and bathroom exhaust fans.

*Loose-fill insulation:* Fibrous insulation in small fibers that installers blow into a building assembly using a blowing machine.

*Low-flow rings:* Part of a blower door that forces air past the sensors fast enough to obtain a reliable reading.

*Low-E:* Short for “low emissivity”, which means the characteristic of a metallic glass coating to resist the flow of radiant heat.

*Low expanding foam:* Liquid-applied form that expands 20-30 times its liquid size.

*Low water cutoff:* A float-operated control to turn the burner off if a steam boiler is low on water.

*Lumen:* A unit of light output from a lamp.

*Luminaire:* A light fixture.

*Main panel box:* The electric service box containing a main switch, and the fuses or circuit breakers located inside the home.

*Make-up air:* Air supplied to a space to replace exhausted air.

*Manifold :* A tube with one inlet and multiple outlets, or multiple inlets and one outlet.

*Manometer:* A differential gauge used for measuring pressure.

*Manufactured homes:* Transportable homes that are faster and less expensive to build compared to site-built homes.

*Mastic:* A thick creamy substance used to seal seams and cracks in building materials, especially ducts.

*Masonry:* Stone, brick, or concrete block construction.

*Mean radiant temperature (MRT):* The area-weighted mean temperature of all the objects in an environment.

*Mechanical draft:* A combustion appliance with induced draft of forced draft.

*Meeting rails:* The rail of each sash that meets a rail of the other when the window is closed.

*Membrane:* A barrier that separates two environments. Membranes may be permeable to the flow of air, water, and other fluids or particles.

*Microclimate:* A very localized climatic area, usually a small site or habitat.

*Micron:* A micrometer or 1/100,000 of a meter.

*Mildew:* Fungi that colonize organic building materials.

*Minimum Efficiency Rating Value (MERV):* The dominant industry rating of the ability of HVAC air filters to remove particles.

*Mitigate:* To make better or reduce some negative effect.

*Mobile home belly:* Part of a home that contains the insulation, duct system, and plumbing. It is enclosed by the sub- and finished floor, with a rodent barrier underneath.

*Mobile Home Energy Audit (MHEA):* A software tool that predicts manufactured home energy consumption and recommends weatherization retrofit measures.

*Moisture meter:* An instrument for measuring the percentage of water in a substance.

*Mold:* A growth of minute fungi forming on vegetable or animal matter and associated with decay or dampness.

*Monitor:* The process through which a person, frequently a representative of a State or Federal agency, visits completed units to ensure that weatherization funding is spent appropriately.

*Mortar:* A mixture of sand, water, and cement used to bond bricks, stones, or blocks together.

*Mortise:* A recessed area cut into the wood framing member where a hinge or wood tongue fits.

*Mud sill:* A wood component attached to the foundation of a building that creates a means of attaching various components of the framing to the foundation.

*Mullion:* Vertical framing members that don't run the full length of the door.

*Multifamily (MF) housing:* A building with five or more residential units.

*Mushroom vent:* A vent that has at the top of a vertical shaft a broad rounded cap that can be screwed down to close it.

*Nail fin or flange:* Semi-flexible strips of metal or plastic used to attach a window frame to the outside of a rough opening.

*National Association for State Community Services Programs (NASCSPP):* Assists States in responding to poverty issues. NASCSPP members are state administrators of the Community Services Block Grant (CSBG) and U.S. Department of Energy's Weatherization Assistance Program (DOE/WAP).

*National Electric Code (NEC):* A safety code regulating the electricity use. The NEC is a product of the National Fire Protection Association.

*National Energy Audit Tool (NEAT):* Created by Oak Ridge National Laboratories as a DOE approved audit qualifying for the 40% materials waiver. It is a computerized auditing tool for prioritizing energy conservation measures for houses.

*National Fenestration Rating Council (NFRC):* NFRC is a non-profit organization that administers the only uniform, independent rating and labeling system for the energy performance of windows, doors, skylights, and attachment products.

*National Fire Protection Association (NFPA):* Creates and maintains minimum standards and requirements for fire prevention, training, and equipment, developing and publishing codes and standards such as the NFPA 70, the National Electric Code, and NFPA 54, the National Fuel Gas Code.

*National Institute for Occupational Safety and Health (NIOSH):* A federal agency responsible for conducting research and making recommendations for the prevention of work-related injury and illness to help ensure safe and healthful working conditions.

*Natural draft:* Draft that relies on the buoyancy of heated gases (not a fan) to move combustion gases up a chimney.

*Natural gas:* A hydrocarbon gas that is usually obtained from underground sources, often in association with petroleum and coal deposits.

*Natural ventilation:* Ventilation using only natural air movement without fans.

*Net-free vent area (NFVA):* The area of a vent after that area has been adjusted for insect screen, louvers, and weather covering. The free area is always less than the actual area.

*Netting:* An open weave fabric or plastic mesh that supports fibrous insulation. See *insulation restrainer*

*NFPA:* National Fire Protection Association.

*NFPA 211:* National Fire Protection Association's Standard for Chimneys, Fireplaces, Vents, and Solid-Fuel-Burning Appliances includes installation procedures for vents and chimneys that serve wood-burning stoves and fireplaces.

*NFPA 31:* National Fire Protection Association's Standard for the Implementation of Oil-Burning Equipment, dictating that

chimneys must be at least 2 feet higher than any portion of the building within 10 feet.

*NFPA 54*: National Fire Protection Association's National Fuel Gas Code.

*Noncombustible material*: Materials that pass the test procedure for defining noncombustibility of elementary materials set forth in ASTM E 136.

*Nonconditioned space*: A space that isn't heated or cooled.

*Non-expanding foam*: Spray foam that doesn't expand. Used in window and door jambs, and other constricted spaces where expanding foam may distort building window or door frames.

*Nozzle*: An orifice for spraying a liquid like fuel oil.

*O<sub>2</sub>*: Oxygen

*Oak Ridge National Laboratory (ORNL)*: Laboratory where the Mobile Home Energy Audit (MHEA) software was developed.

*Occupants*: People of any age living in a dwelling. Animals are not defined as occupants.

*Occupational Safety and Health Administration (OSHA)*: An agency of the United States Department of Labor, with a mission to prevent work-related injuries, illnesses, and occupational fatalities by issuing and enforcing standards for workplace safety and health.

*Off-gas*: Off-gassing is the evaporation of volatile chemicals in non-metallic materials at normal atmospheric pressure. This means that building materials can release chemicals into the air through evaporation.

*Ohm*: A unit of measure of electrical resistance. One volt can produce a current of one ampere through a resistance of one ohm.

*One-part foam*: One-part foam comes in spray cans (e.g., Great Stuff) and spray guns with screw-on cans. One-part foam is best suited for filling gaps and holes less than 3/4-inch.

*Open-combustion appliance:* An appliance that doesn't have a sealed combustion chamber and draws its combustion air from the surrounding room.

*Orifice:* A hole in a gas pipe or nozzle fitting where gas or fuel oil exits to be mixed with air before combustion occurs in the heating chamber. The diameter of the orifice determines the flow rate.

*Orphaned water heater:* A gas water heater that formerly shared a chimney with a gas furnace or boiler but now is the only appliance venting into the naturally drafting chimney.

*Oscillating fan:* A fan, usually portable, that moves back and forth as it operates, changing the direction of the air movement.

*OSHA :* Occupational Safety and Health Administration

*Output capacity:* The useful heat in BTUH that a heating unit produces after accounting for waste.

*Over-fired:* When a burner burns too much fuel caused by oversized fuel nozzles or excessive fuel pressure.

*Oxidation:* The chemical reaction of a substance with oxygen.

*Oxygen content:* A measure of the amount of oxygen in the air or combustion gases as a percent.

*Oxygen-depletion sensor:* A safety device on a heating unit that shuts off the fuel supply when oxygen content of the combustion air is inadequate.

*Packaged air conditioner:* An air conditioner that contains the compressor, evaporator, condenser, and air handler in a single cabinet.

*Packaged terminal (PT):* A self-contained space heating and/or cooling system, usually powered with electricity, .

*Packaged terminal air conditioner or heat pump (PTAC or PTHP):* A self-contained space heating and/or cooling system, frequently installed in a sleeve through the exterior wall of a

building, using heat pump technology. Common in hotels and apartment buildings.

*Panel:* Parts of a door between rails and stiles or mullions.

*Parapet walls:* A low wall at the edge of a low-sloping roof.

*Parts per million (ppm):* The unit commonly used to represent the degree of pollutant concentration, where the concentrations are small.

*Pascal (Pa):* A unit of measurement of air pressure. One inch of water column equals 249 pascals. Atmospheric pressure (29.92 inches of mercury) is equivalent to 102,000 pascals

*Passive attic venting:* Takes advantage of the natural buoyancy of air by providing inlets and outlets low and high on the roof.

*Payback period:* The number of years that an investment in energy conservation requires to repay its cost through energy savings.

*Performance standard:* Specification of the conditions that exist when a someone performs a job in an approved manner.

*Perimeter basement drain:* An indoor drain cut into the floor and around the perimeter of a basement or crawl space to intercept and remove water from the basement.

*Perlite:* A heat-expanded non-combustible mineral used for insulation.

*Perm:* A measurement of how much water vapor a material transmits per hour. Specifically: diffusion of 1 grain of water vapor per hour, per square foot, per inch of mercury pressure.

*Permeance rating:* Number that quantifies the rate of vapor diffusion through a material.

*Personal fall arrest system:* A system used to arrest an employee in a fall from a working level. It consists of an anchor point, connectors, a body belt or body harness and may include a lanyard, deceleration device, lifeline, or combinations of these.



*Personal protective equipment (PPE):* Accessories such as safety glasses, ear plugs, and respirators worn to protect individuals from workplace hazards.

*Phase change:* The act of changing from one state of matter to another, for example: solid to liquid or liquid to gas.

*Photoresistor:* Electronic sensing device used to sense flame, sunlight, artificial light.

*Photovoltaic (PV):* A solid-state electronic device that converts light into direct current electricity.

*PIC:* Polyisocyanurate foam insulation.

*Picture window:* Picture windows have no operable sashes and are used primarily for outdoor viewing and daylighting.

*Pier and beam foundation:* Housing base that uses a concrete footing and a pier to support the floor, walls, and roof.

*Pitch:* The slope of a roof expressed as the rise over the run or by an angle in degrees.

*Plaster:* A plastic mixture of sand, lime, and Portland cement spread over wood or metal lath to form the interior surfaces of walls and ceilings.

*Plastic tie band:* A ratcheting plastic band used to clamp wires or flexible ducts to metal ducts or to attach insulation to round metal ducts.

*Plate:* A framing member installed horizontally to which the vertical studs in a wall frame are attached.

*Platform framing:* A system of framing a building in which floor joists of each story rest on the top plates of the story below or on the foundation sill for the first story, and the bearing walls and partitions rest on the subfloor of each story.

*Plenum:* The large duct that connects the air handler to the main ducts.

*Plumb:* Absolutely vertical at a right angle to the earth's surface.

*Plywood*: Laminated wood sheeting with layers cross-grained to each other.

*PM*: Particulate matter or particle pollution. PM<sub>2.5</sub> particles are less than 2.5 microns in diameter. PM<sub>10-2.5</sub> are between 2.5 and 10 microns in diameter.

*Pocket doors*: Doors that slide into a wall cavity and typically leak a lot of air.

*Polyethylene*: A plastic made by the polymerization of ethylene, used in making, lightweight, and tough plastics, films, insulations, and vapor barriers.

*Polyisocyanurate (PIC)*: A plastic foam insulation sold in sheets, similar in composition to polyurethane.

*Polystyrene insulation*: A rigid plastic foam insulation, usually white, pink, green, or blue in color.

*Polyurethane*: A versatile plastic spray-foam insulation, usually yellow in color.

*Porosity*: Measure of the void spaces in a material, expressed as either a fraction or a percentage of the total volume of material.

*Positive-pressure, supplied-air respirator*: Has its own air compressor to supply fresh air to the worker through a sealed mask or hood.

*Potential energy*: Energy in a stored form, like fuel oil, coal, wood, or water stored in a reservoir.

*Potentiometer*: A variable resistor used as a controller or sensor.

*Pounds per square inch (psi)*: Units of measure for the pressure a gas or liquid exerts on the walls of its container.

*Power burner*: A burner that moves combustion air at a pressure greater than atmospheric pressure. Most oil-fired burners and many larger gas burners are power burners.

*Power venter:* A blower located on the inside or outside of an exterior wall that pulls the combustion gases out of the appliance and exhausts these gases outdoors.

*Prescriptive standard:* Specifies in detail the requirements and procedures to be followed rather than specifying a performance outcome.

*Present value (PV):* The amount that a future sum of money is worth today considering a specific *discount rate*.

*Pressure:* A force encouraging movement of a fluid by virtue of a difference in density, elevation, or some other condition between two places.

*Pressure-and-temperature relief valve:* A safety component required on boilers and water heaters, designed to relieve excess pressure or temperature in the tank by discharging water.

*Pressure balancing:* To equalize house or duct pressure by adjusting supply and return airflow in ducted forced-air distribution systems.

*Pressure boundary:* The surface that separates indoor air from outdoor air. Also called the air barrier.

*Pressure diagnostics:* The evaluation of building pressures and airflows in order to control air leakage and to ensure sufficient airflow for heating, cooling, and ventilation.

*Pressure-equalized rain screen:* A space between the water-resistive barrier and the exterior cladding in a wall that connects to the outdoors so that no pressure difference exists between the space and the outdoors. This assembly gives superior resistance to wind and wind-driven rain.

*Pressure-pan testing:* One method for determining duct leakage. Uses a pressure pan, manometer, and a blower door to quantify pressure differences and verify improvements after duct sealing.

*Pressuretrol:* A control that turns a steam boiler's burner on and off as steam pressure changes.

*Pressure-reducing valve:* An adjustable valve that reduces the building's water pressure to provide water to hydronic and steam heating systems and potable-water systems.

*Primary air:* Air mixed with fuel before combustion.

*Prime window:* The main window installed in the rough opening consisting of fixed or moveable sashes (not to be confused with a storm window).

*Priority list:* The list or ranking of energy-conservation measures developed by a program to produce the most cost-effective energy savings results based on a savings to investment ratio calculation.

*Propane (liquefied petroleum gas, or LPG):* A colorless, flammable gas occurring in petroleum and natural gas.

*Psychrometer:* An instrument for determining atmospheric humidity by the reading of two thermometers, the bulb of one being kept moist and ventilated.

*Psychrometric chart:* A chart presenting the physical and thermal properties of moist air in graphical form. Used in conjunction with a psychrometer to determine relative humidity, dew point, enthalpy, and other characteristics of humid air.

*Psychrometrics:* The study of the relationship between air, water vapor, and heat.

*Pull-down stairs:* Staircase that folds up into the attic until pulled down for use.

*Pulley seals:* A component of a double-hung window sash that minimizes air leakage through the pulley hole.

*Purlins:* Framing members that sit on top of rafters, perpendicular to them, designed to spread support to roofing materials.

*Quality assurance (QA):* The systematic evaluation of a product or service to ensure quality standards are being met.

*Quality control (QC):* Review of the final work product to ensure that it was correctly done.

*QCI or Quality control inspection:* Detailed inspection of the final work product and its relationship to the energy audit and work order.

*R-Value:* A measurement of thermal resistance of materials, especially layered materials.

*Radiant barrier:* A metalized sheet or coating designed to reflect radiant heat or to resist the emission of radiant heat.

*Radiant temperature:* The surface temperature of objects in a home, like walls, ceiling, floor, and furniture.

*Radiation:* Heat energy that is transferred by electromagnetic energy or infrared light, from one object to another. Radiant heat can travel through a vacuum, through air, or through other transparent and translucent materials.

*Radon:* A carcinogenic radioactive gas that decomposes into radioactive particles.

*Rafter:* A roof support that supports the roof deck and follows the roof's slope.

*Rain screen:* The combination of a water-resistive barrier and a space, used to keep wall assemblies dry in climates with substantial rainfall.

*Rater:* A person who performs energy ratings. Same as *energy rater*.

*Recovery efficiency:* A water heater's efficiency at actually heating water to the water heater's rated capacity without considering standby or distribution losses.

*Reflectance:* The ratio of radiant heat reflected from a given surface to the total radiation falling on the surface. Also called *reflectivity*.

*Reflective glass:* Glass that has a mirror-like coating on its exterior surface to reflect solar heat. The solar heat gain coefficient of reflective glass ranges from 0.10 to 0.30.

*Refrigerant:* A fluid used in air conditioners and heat pumps that heats air when it condenses from a gas to a liquid and cools air when it evaporates from a liquid to a gas.

*Register:* The grill cover over a duct outlet for forced-air distribution systems and may control the airflow.

*Relamping:* The replacement of an existing, standard light bulbs with lower wattage energy-efficient bulbs.

*Relative humidity:* The percent of water vapor that air contains, compared to the maximum amount of water vapor the air can hold. Air that is completely saturated has 100% relative humidity.

*Relay:* An automatic, electrically-operated switch.

*Reset controller:* Adjusts fluid temperature or pressure in a HVAC system according to the outdoor air temperature.

*Residential Load Calculation: Manual J:* Allows the user to properly size building HVAC systems.

*Resistance:* The property of a material resisting the flow of electrical energy or heat energy.

*Respirable:* Able to be breathed deeply into human lungs.

*Retrofit:* An energy conservation measure applied to an existing building.

*Return air:* Air circulating back to an *air handler* from the building, to be heated or cooled and supplied back to the building's conditioned areas.

*Return plenum:* A large main duct that brings *return air* back to the *air handler*.

*Revolutions per minute:* Number of times the crankshaft of an combustion engine, or the shaft of an electric motor, rotates in one minute.

*Reweatherized unit:* Any unit that received weatherization services prior to September 30, 1994 and has received additional

services under subsequent grants or allowed by current DOE regulations.

*Ridge venting:* Ridge venting is a continuous vent (or two strips of vents) along the roof ridge. Usually combined with continuous *soffit* or eave vents as part of an overall attic-ventilation system.

*Rim joist:* The outermost joist around the perimeter of the floor framing. Also known as band joist.

*Riser:* Transition piece that connects the main duct to the floor and is often vulnerable to failure. Also the vertical part of a stair step. See also *duct boot*.

*Rodent barrier:* Guard used to keep rodents from entering a mobile home through its belly.

*Roof jack:* Chimney assembly that penetrates the roof and includes the flashing and chimney cap assemblies.

*Roof vent:* A screened and louvered opening to allow air exchange between the attic and outdoors.

*Room air conditioner:* An small air conditioning unit installed through a wall or window, which cools a room by removing heat and releasing it outdoors.

*Room heater:* A heater located within a room and used to heat that room.

*Rough opening:* The framed opening in a wall into which a door or window is installed.

*SDS:* Safety Data Sheet.

*Safety Data Sheet (SDS):* A sheet containing data regarding the properties of a particular substance, intended to provide workers with procedures for handling or working with that substance in a safe manner, including information such as physical data, toxicity, health effects, first aid, storage, disposal, and protective equipment.

*Safety glass*: Glass that is toughened or laminated so that it is less likely to splinter when broken.

*Sash*: A movable or stationary part of a window that frames the glass.

*Saturation*: Describing a mixture of vapor and liquid at the *phase-change* point. The condition in which the air can't hold any more moisture, as a function of temperature and *vapor pressure*.

*Savings-to-investment ratio (SIR)*: SIR is the cash savings divided by the initial investment over the lifespan of energy-conservation measures. SIRs of greater than one are considered cost effective according to DOE WAP.

*Scale*: Dissolved minerals that precipitate inside boilers and storage tanks.

*Sealed-combustion heater*: A heater that draws air for combustion from outdoors and has a sealed exhaust system. Also called a *direct-vent* appliance.

*Seasonal efficiency*: Refers to the overall efficiency of the central heating system including AFUE and distribution losses.

*Seasonal energy efficiency ratio (SEER)*: A measurement of energy efficiency for central air conditioners. The SEER is computed by dividing cooling capacity, measured in BTUh, by the Watts (see also *Energy Efficiency Rating*).

*Seasonal heating performance factor (SHPF)*: Ratio of useful heat output of a heat pump to the electricity input, averaged over a heating season.

*Secondary air*: Combustion air surrounding a flame.

*Sensible heat*: The heat required to change the temperature of a material.

*Sequencer*: A bimetal switch that turns on the elements of an electric furnace in sequence.



*Service equipment:* The electric meter and main switch, usually located outside the building.

*Service wires:* The wires coming from the utility transformer to the service equipment of the building.

*Set-point:* The temperature setting of a thermostat or other temperature-based control.

*Shading coefficient (SC):* A decimal describing how much solar energy is transmitted through a window opening compared to clear single glass having an SC of 1.0. For example, reflective glass has an SC of 0.20 to 0.40.

*Sheathing:* Structural sheathing, attached on top of the framing, underneath the siding and roofing of a building. Any structural building material used for covering a building surface.

*Sheet Metal and Air Conditioning Contractors' National Association (SMACNA):* An international association of contractors who specialize in heating, ventilation and air conditioning.

*Sheeting:* Common term for any building material used for covering a building surface.

*Sheetrock:* See *drywall*.

*Shell:* The building's exterior envelope including walls, floor, and roof.

*Shingle:* A modular waterproof roofing material, that installs in overlapping rows to cover the roof surface.

*Short circuit:* A dangerous malfunction in an electrical circuit where electricity flows through conductors and into the ground without going through an *electrical load*.

*Sill:* The bottom of a window or door frame.

*Sill box:* The outer area of the floor bound by the *rim joist*, floor joist, sill plate, and floor.

*Sill pan:* A flashing device that sits on a rough-framed window sill to prevent water penetration if water infiltrates the cladding and sealant around the finished window.

*Single-family (SF) home:* A free-standing residential building, occupied by one family unit.

*SIR:* See *savings-to-investment ratio*.

*Skirting:* A non-structural screening built around the exterior of an open crawl space to exclude animals, wind, and sunlight. Also has aesthetic value.

*Slab-on-grade foundation:* Building foundation using a concrete slab usually poured at one time.

*Slider window:* A slider window is essentially a double-hung window turned on its side so the sashes move horizontally.

*Sling psychrometer:* A device holding two thermometers that is slung through the air to measure wet-bulb temperature and dry-bulb temperature for calculating relative humidity, enthalpy, and other *psychrometric* factors.

*Slope:* The roof section of an attic with the roof and ceiling surfaces attached to the rafters. See also: *pitch*.

*Smoke-developed index:* The level of smoke that a material produces when burning in a fire test compared to red oak, which has an index of 100.

*Smoke tester:* Device to test the amount of smoke being produced by an oil-burning furnace or boiler. High smoke means the fuel-to-air ratio is incorrect, and combustion is inefficient.

*Soffit:* The underside of a roof overhang or a small lowered ceiling, as above cabinets or a bathtub.

*Solar absorption:* The ratio of absorbed solar radiation to incident solar radiation.

*Solar control film:* Plastic films, coated with a metallic reflective surface, that are adhered to window glass to reflect solar heat gain. See also window film.

*Solar gain:* Heat from the sun that is absorbed by a building's materials and contributes to the heating and cooling requirements of the dwelling.

*Solar heat:* Radiant energy from the sun with wavelengths between 0.7 and 1 micrometers.

*Solar heat gain coefficient (SHGC):* The ratio of solar heat gain through a window to incident solar heat, including both transmitted heat and absorbed/radiated heat.

*Solar reflectance:* The ratio of reflected solar radiation to incident solar radiation. See also albedo.

*Solar screen:* A framed screen, installed on the window's exterior, designed to absorb solar heat before it strikes window glass.

*Solar transmittance:* The percent of total solar energy transmitted by a transparent or translucent material.

*Solar water heater:* Water-heating system where solar radiation heats the water.

*Solenoid:* An electromagnetic device that moves a switch or valve stem.

*Sone level:* An international unit used to measure sound levels. One sone is equivalent to the sound of a quiet refrigerator in a quiet kitchen.

*Space conditioning:* Heating, cooling, or ventilation of an indoor space.

*Space heating:* Heating of the building's living spaces with a room heater or central heating system.

*Spalling:* Surface degradation of masonry materials because of moisture movement.

*Span:* Horizontal distance between supports.

*Specific heat:* The ratio of the heat storage capacity of a particular material to the heat storage capacity of water.

*Spillage*: Temporary flow of combustion gases from a *dilution device*.

*Spline*: A strip of vinyl, rubber, or plastic that, when inserted into a groove, holds a screen or plastic film in place on a frame.

*Split-system air conditioner*: An air conditioner having the condenser and compressor outdoors and the evaporator indoors.

*Spray foam*: Liquid-applied foam that expands forming a rigid foam material with millions of insulating cells.

*Spot ventilation*: Spot ventilation includes kitchen exhaust fans and bathroom exhaust fans. See also *local ventilation*.

*Stack effect*: The draft established in a building from outdoor air infiltrating low and exfiltrating high.

*Standard Work Specifications*: Voluntary guidelines for quality work for residential energy upgrades. These specifications define the minimum requirements for high-quality installation of energy-conservation measures.

*Standing loss*: Heat loss from a hot water storage tank through its shell.

*State point*: Air at a particular temperature and humidity occupies a single point on the psychrometric chart called a state point.

*Static pressure*: Measurement of pressure in a fluid filled chamber at a specific location, and at a right angle to the fluid flow.

*Steady-state efficiency (SSE)*: The heating-efficiency percentage calculated by a combustion analyzer by measurements of oxygen and flue-gas temperature.

*Steel chassis*: Supporting under-frame for the mobile home.

*Steam trap*: An automatic valve that closes to trap steam in a radiator until it condenses.

*Steam vent:* A bimetal-operated air vent that allows air to leave steam piping and radiators, but closes when steam arrives at the vent.

*Stiles:* Full-length vertical framing members of a door.

*Stop:* A thin, trim board for windows and doors to close against or slide against.

*Strapping:* Similar to furring. A nailer applied to a building surface.

*Strike plate:* The metal plate attached to the door jamb that the latch inserts into upon closing.

*Strip heat:* An electric-resistance heating cable or element as in a heat pump for electric resistance heater.

*Stucco:* Plaster applied to the building's exterior walls.

*Stud:* A vertical wood or metal framing member used to build a wall.

*Subfloor:* The sheathing over the floor joists and under the floor covering.

*Subspace:* A space or zone located partially or completely below grade, such as a basement or crawl space.

*Subcooling:* The number of degrees Fahrenheit that a condenser and nearby piping cools the liquid refrigerant below its saturation temperature.

*Subgrantee:* An agency—usually a community action agency—that is awarded a sub-grant and is accountable to the grantee (State government) for managing weatherization at a local level.

*Substrate:* A layer of material to which another layer is applied.

*Sulfur dioxide (SO<sub>2</sub>):* A colorless, nonflammable, water-soluble gas air pollutant.

*Sump pump:* A pump that removes water from underneath a building.

*Superheat:* The number of degrees Fahrenheit that an evaporator and nearby piping heats gaseous refrigerant above its saturation temperature.

*Supply air:* Heated or cooled air that moves out of an *air handler* through the ducts and to the *supply registers* of a building.

*Suspended ceiling:* Modular ceiling panels supported by a hanging frame.

*Tankless water heater:* A water heater with no storage tank that heats water instantaneously as the water flows through it. Also called: *instantaneous water heater*.

*Task lighting:* Lighting provided at the area where a visual task is performed.

*Temperature:* A measure of the heat present.

*Temperature and pressure relief valve:* A safety component required on boilers and water heaters, designed to relieve excess pressure or temperature in the tank by discharging water.

*Temperature rise:* The number of degrees of temperature that the heating fluid increases as it moves through the heat exchanger.

*Therm:* A unit of energy equal to 100,000 Btus or 29.3 kilowatt-hours.

*Thermal barrier:* A material that protects materials behind it from flame impingement or from reaching 250° F during a fire. Drywall is a 15-minute thermal barrier.

*Thermal boundary:* A line or plane where insulation and air barrier(s) exist in order to resist thermal transmission and air leakage through or within a building envelope.

*Thermal break:* A relatively poor heat-conducting material separating two highly conductive materials, installed to reduce heat flow through the assembly.

*Thermal bridging:* Rapid heat conduction resulting from direct contact between very thermally conductive materials like metal and glass.

*Thermal bypass:* A large air leak that allows air to flow around insulation.

*Thermal conductance:* A homogeneous material's ability to conduct heat, denoted by the letter *k*.

*Thermal emittance:* Thermal emittance or thermal emissivity is the ratio of the radiant emittance of heat of a specific object or surface to that of a standard object called a black body.

*Thermal enclosure/envelope:* The insulated and air-sealed boundaries of a dwelling that surround the conditioned space.

*Thermal mass:* A solid or liquid material that absorbs and stores heating or cooling energy until it is needed.

*Thermal resistance:* R-value; a measurement expressing the ability to resist heat flow.

*Thermal transmittance:* Expressed as U-factor, thermal transmittance is heat flow by conduction, convection, and radiation through a layered building component like a wall.

*Thermistor:* An electronic resistor used to sense temperature.

*Thermocouple:* A bimetal-junction electric generator used to keep the safety valve of an automatic gas valve open.

*Thermodynamics:* The science of heat.

*Thermostat:* A device used to control a heating or cooling system to maintain a *setpoint* temperature.

*Threshold:* The raised part of a floor underneath a door that acts as an air and dust seal.

*Ton of refrigeration:* The capacity to remove 12,000 BTUs per hour of heat from a building.

*Total solar energy rejected:* The percent of incident solar energy rejected by a glazing system equals solar reflectance plus the part of solar absorption that is reradiated outward.

*Tracer gas:* A harmless gas used to measure air leakage in a building.

*Training and technical assistance (T&TA):* Formal technical communication that ensures that all work in the field meets State standards.

*Transformer:* A double coil of wire that increases or decreases voltage from a primary circuit to a secondary circuit.

*Trim:* Decorative wood that covers cracks around window and door openings and at the corners where walls meet floors and ceilings. Sometimes called molding.

*Truss:* A braced framework usually in the shape of a triangle to form and support a roof.

*Tuck-under garage:* Architectural style in which the garage is situated underneath a room of the house.

*Turbine vent:* Vent usually mounted on the roof of a building. The vent has at its head a globular, vaned rotor that is rotated by wind, conveying air through a duct to and from a chamber below.

*Two-part foam:* A triple-expanding foam that insulates and seals air leaks. Two-part foam comes in portable low-pressure two-tank kits and high-pressure truck-mounted spray systems.

*Type IC recessed electrical fixture:* An recessed light fixture that is rated to be in direct contact with fibrous insulation.

*Type-S fuses:* Fuse type with a rejection base that prevents tampering as well as mismatching.

*U-factor:* The total heat transmission of a building assembly in BTUs per square feet per hour per degree Fahrenheit between the indoor and the outdoors.



*U.S. Department of Agriculture (USDA):* United States government agency responsible for agricultural programs, USDA also administers some housing programs.

*U.S. Department of Energy (DOE):* United States government agency whose mission is to advance energy technology and promote related innovation in the United States.

*U.S. Department of Housing and Urban Development (HUD):* United States government agency charged with rule-making and enforcement of the HUD Code for manufactured homes.

*U.S. Environmental Protection Agency (EPA):* The mission of the U.S. Environmental Protection Agency is to protect human health and the environment.

*U-value:* See U-factor. An international term for *U-factor*.

*Ultraviolet Radiation:* Light radiation having wavelengths beyond the violet end of the visible spectrum; high frequency light waves.

*Unconditioned crawl space:* A crawl space without a supply of heat from a forced-air register or other heat emitter.

*Unconditioned space:* An area within the building envelope not intentionally heated.

*Underlayment :* Sheeting installed to provide a smooth, sound base for a finish material.

*Under-fired:* Describes a burner that isn't receiving a sufficient flow rate of fuel.

*Underwriter's Laboratory (UL):* A private laboratory that tests materials and lists their fire-resistance characteristics.

*Uniform Mechanical Code (UMC):* A model code developed by the International Association of Plumbing and Mechanical Officials to govern the installation and inspection of mechanical systems.

*Uniform Plumbing Code (UPC):* A model code developed by the International Association of Plumbing and Mechanical Officials to govern the installation and inspection of plumbing systems.

*Unintentionally conditioned:* A space that is heated or cooled by energy that escapes the heating or cooling system. For example: a cooled attic or heated crawl space, which have no intentional space conditioning or comfort needs.

*Unitary:* Refers to an HVAC system that has all its components in one cabinet. See also: Packaged

*Unvented attic:* An attic space without intentional vents to ventilate it.

*Upduct:* An automatic vent, between the conditioned space and the attic, that operates by the pressure created by an evaporative cooler. Upducts exhaust room air into the attic. Used when open windows are a security problem.

*Upflow furnace:* A furnace in which the heated air flows upward as it leaves the furnace.

*Upstream:* Toward the source of the flow.

*Vapor barrier:* A material that controls water-vapor *diffusion* to less than 0.1 perms.

*Vapor diffusion:* The flow of water vapor through a solid material.

*Vapor permeable:* A material with a water vapor *permeance* of more than 10 perms.

*Vapor pressure:* The pressure exerted by a vapor, which increases with temperature.

*Vapor retarder:* A material that limits water-vapor diffusion to less than 10 perms.

*Vaporize:* To change from a liquid to a gas.

*Vaulted attic/ceiling:* An attic bounded by a sloped ceiling and sloped roof, which is created by a roof truss and typically has more than 16 inches of space between the ceiling and roof.

*Veiling reflection:* Light reflection from an object or task that obscures visibility.

*Veneer:* The outer layer of a building component that protects or beautifies the component.

*Vent connector:* The vent pipe carrying combustion gases from the appliance to a vent or chimney.

*Vent chute:* A lightweight plate that directs air from a soffit over attic insulation and along the bottom of the roof deck to ventilate the attic and cool the roof deck. A *baffle*.

*Vent damper:* An automatic damper powered by heat or electricity that closes the chimney while a heating device is off.

*Vent pipe:* The pipe carrying combustion gases from the appliance to the chimney.

*Vent terminations:* A fitting that prevents moisture intrusion, detritus, or pests into the building, and allows safe exhaust of vented gases.

*Vented crawl space:* Crawlspace with grilles or vents installed to allow for passive ventilation beneath the home.

*Venting:* The removal of combustion gases by a chimney or horizontal vent.

*Venting system:* A continuous passageway from a combustion appliance to the outdoors through which combustion gases can safely pass.

*Ventilation:* Refers to the controlled air exchange within a structure such as local ventilation, whole-house ventilation, attic ventilation, and crawl space ventilation.

*Vermiculite:* A heat-expanded fire-resistant mineral used for insulation.

*Visible transmittance:* The percent of visible light transmitted by a glass assembly.

*Visqueen:* Polyethylene film vapor barrier.

*Volt:* The amount of electromotive force required to push a current of one ampere through a resistance of one ohm.

*Voltage drop:* The reduction of voltage in a circuit caused by resistance.

*Volume:* The amount of space occupied by a three-dimensional object or region of space, expressed in cubic units.

*Water-resistive barrier:* A water-resistant material used to prevent water from wetting a building's structural sheathing and other vulnerable components.

*Watt (W):* A unit of measure of electric power at a point in time, as capacity or demand. One Watt of power is equal to one *joule* per second.

*Watt-hour:* One Watt of power used continuously for one hour. One thousandth of a kilowatt-hour.

*Watt meter:* An instrument for measuring watts of electric power in a circuit.

*Weatherization:* The process of reducing energy consumption and increasing comfort in buildings by improving the energy efficiency of the building while maintaining health and safety.

*Weatherization Assistance Program (WAP):* DOE's Weatherization program.

*Weatherization program notices (WPN):* Guidance documents issued by the U.S. Department of Energy for the weatherization program.

*Weather-resistant barrier:* See *water-resistive barrier*.

*Weatherstripping:* Flexible *gaskets*, often mounted in rigid metal strips, for limiting air leakage at openings in the building envelope such as doors and windows.

*Webbing*: A reinforcing fabric used with mastics and coatings to prevent the coating from cracking.

*Weep holes*: Holes drilled for the purpose of allowing water to drain out of an area in a building where it accumulates.

*Wet-bulb temperature*: The temperature of a dampened thermometer of a *sling psychrometer* used to determine relative humidity, dew point, and enthalpy.

*Wet spray*: Fibrous insulation mixed with water and sometimes also a binder during installation.

*Whole-house fan*: A fan that draws fresh outside air into the living space, flushes hot air up the attic and exhausts it to the outside.

*Whole-building ventilation*: Controlled air exchange using one or more fans and ducts to maintain good indoor air quality and to keep the building sufficiently dry.

*Wind effect*: Building pressure and airflow between indoor and outdoors caused by the wind.

*Wind washing*: Wind-driven air passing over and through building materials, particularly insulation.

*Window films*: Plastic films coated with a metallic reflective surface that adhere to window glass in order to reflect solar radiation.

*Window frame*: The sides, top, and sill of the window forming a box around window sashes and other components.

*With reference to (WRT)*: Compared to another measurement. In weatherization, a way to assess pressure differences between ducts and the rest of the home.

*Work order*: An order authorizing workers to complete specified tasks. Sometimes called the work scope.

*Workforce Guidelines*: DOE guidance on specific energy conservation measures; also called *Standardized Work Specifications*.

*Work scope:* The summary of energy conservation measures, materials lists and labor estimates that is prepared by an energy auditor as part of an energy audit. Same as: *work order*.

*Worst-case depressurization test:* A safety test, performed by specific procedures, designed to evaluate the probability of chimney back-drafting.

*Zone:* A room or portion of a building separated from other rooms by an air barrier.

*Zone pressure diagnostics (ZPD):* Using a blower door to determine the interconnectivity of various building components, which helps the practitioner locate the air barrier and know if the insulation and air barrier are aligned. Also called zonal pressure diagnostics.

# INDEX

## A

Acoustical sealant	102	stairways	130, 214
Adhesives		Air permeance	
caulking as	101-103	of building materials	559
construction	103	Air quality	21
for polystyrene foam	103, 229	See also Indoor air quality	
Air barriers		Air sealing	
air permeance of	559	door/window frames	180
definition	559	duct boots	371-376
primary vs. secondary	560	masonry surfaces	180
testing for leaks	557-566	materials for	98-100
Air conditioners		mobile homes	507-510
inspections	403-405	multifamily	97
refrigerant charge	407	return ducts	372-373
Air filters		supply ducts	374-376
assembly improvements	361	Air separator	383
MERV ratings	360	Air shutters, oil	318
MERV, ventilation	424	Airflow	
oil burner	321	improving low	357
selection	360	testing for unbalanced	348-349
supply ventilation	436	troubleshooting	344-349
ventilation	417	ventilation standards	417-421
Air handlers		Air-free CO measurement	26
See also Blowers		Air-to-air heat exchangers	436-437
see also Furnaces		Alarms	
rooftop	353	carbon monoxide	27
sealing holes in	298	smoke	27
Air leakage		American Gas Association	
multifamily	550-554	venting categories	338
of materials, rates	559	Appliances	
when to test	544	energy measures	455-482
Air leaks		Asbestos	47-48, 62-63
ceilings	133-134	Attic	
chimneys	337	ventilation	165
floor cavities	132	Attic ventilation	166
plumbing	211	Attics	
porches	130	air sealing	134
size, type	96	finished	132, 155-161
soffits	133	hatches	129
		insulation	139-163
		ventilation	442-445

Average cost per unit (ACPU)	77	nozzle for oil	318
		oil	316-322
<b>B</b>		<b>C</b>	
Backdrafting	276-277	Cad cell	321
Backer rod	100	Cans. See Lights, recessed	
Baffles	444	Cantilevered floor	
Balloon framing	196	testing	565
Band joists		Cantilevered floors	
air sealing	180	air sealing	215
insulation	217-218	Carbon monoxide	24, 296
Baseload		air-free measurement	26
analysis example	93	alarms	27
measures	455-479	causes of	25
Basements		causes/solutions	297
air sealing	215	exposure limits	26
insulation	227-231	standard for oil	319
testing for air leakage	566	testing	26, 276
thermal boundary	207-210	Caulking	508
Bathtub		fire-rated	103
air sealing	212	types of	101-103
Batts		uses of	132-144
floor cavities	221-223	CAZ	290
for basements	228	Ceiling fans	452
open wall cavities	197-199	Ceilings	
batt-stuffing walls	524-525	air leakage	133-134
Blower doors		insulation	139-163
components/description	544-546	Cellulose insulation	
multifamily buildings	550-555	characteristics	109-110
preparing for tests	547	stuffing material	101
pressure diagnostics	557-566	CFL	465
simple zone testing	560-561	See also Compact fluorescent	
test procedures	548	lamps	
testing	544-549	CFM50	
Blowers		defined	545
controls	351	Charge	
Boilers		refrigerant	407-408
corrosion	381	Chimney effect. See Stack effect	
efficiency	383-384	Chimney liners	
low-limit control	384	sizing	334
maintenance/efficiency	381	Chimneys	
sizing	303	air leakage	337
Burners		air sealing around	124
gas, servicing	273-274		



all-fuel	335	Convectors	
and insulation safety	143	fin-tube	384
clearances	335	Cool roofs	533-535
masonry specifications	331	Corrosion	381
measures to improve draft	284	Costs	
mobile homes	505	seasonal/baseload	92
retrofit liners	333, 340	Crawl spaces	
termination	336	air sealing	180
types	331	conditioned	448
when to reline	340	thermal boundary	207-210, 567
Clothes dryers	456, 472-473	ventilation	235
CO	21		
See also Carbon monoxide		<b>D</b>	
Coils		Dampers	
cleaning	404	balancing	344
Combustion		Dehumidifiers	43
oil standards	319	Dense-packed insulation	193-196
problems/solutions	285	Diagnostics	
testing/analysis	293-297	airflow	344-349
the chemical process	294	building shell	557-566
Combustion air		house pressure	369-370
cfm requirements	276, 287	pressure-pan testing	363-366
confined spaces	289-292	unbalanced airflow	348-349
fan-powered	290, 291	Doors	256
methods of providing	288	mobile home	532
mobile home furnaces	504	replacement	264-265
unconfined spaces	288-289	sealing frames	180
Combustion losses		weatherstrip	262, 264
excess air	383	Downspouts	40
Combustion zone		Draft	
definition	276, 287	and duct improvements	283
depressurization	97	measuring, illus.	315
Compact fluorescent lamps	464-466	over-fire	318
Computers, energy consumption	456	strength & types of	276-277
Condenser coils		Draft proofing	
cleaning	404	see also Air sealing	
Construction adhesives	103	Drainage	39-42, 120, 235
Consumption		Drywall	99, 127, 143, 181, 228, 230
of energy	90	Duct blower	
Controls		leak-testing	366-369
economizers	354, 355	Duct mastic	102
enthalpy	354	Ductboard	
		deteriorating facing	375

Duct-induced house pressure		consumption	90
369-370		Energy auditor	
Ducts		responsibilities	75-85
air sealing boots	371-376	Energy audits	
design airflow	353-359	ethics, bias	76
duct-airtightness testing	366-369	Energy consumption	456
evaluating leakage	361-365	Energy factor	491
finding leaks	362-365	water heating	484
improvements to solve draft problems	283	Energy recovery ventilators	436-437
in crawl spaces	219	Energy use	
Insulation	377-378	analysis	90-93
mastic	102	analysis, example	93
mobile home leakage	511-513	EPA lead rules	50-51
pressure-pan testing	363-366	Ethics	76
sealing leaks	371-376	Excess air	
sealing return	372-373	oil burners	319
sealing supply	374-376	Exhaust fans	434, 438
sizing	353	Expansion tanks	382, 383, 489
static pressure	345-347	Fiberglass insulation	
thermal boundary and	568	basements	228
troubleshooting leakage	362-377	characteristics	107-109
Dust		floor batts	221-223
and respirators	52	floor blowing	219-220
protecting clients from	63	for stuffing	100
worker hazard	62-63	mobile homes	515-530
<b>E-F</b>		R-value	182
Economizers	354	wall batts	197-199
Efficiency		Fill tubes	
storage water heaters and	491-494	use for wall insulation	525
Efflorescence	36	Filters	405
Egress windows	253	air, installation	299
Electric furnaces. See Furnaces, electric		Fire partitions	24
Electric heat	392-400	Fire safety	
baseboard	392-393	air-sealing materials	97
furnaces	393-394	caulk	103
Electrical safety	53-54	insulation	141-145
Electrically commutated motors	41, 298, 424	light fixtures	128, 142
Energy		Fireplaces	
baseload measures	455-479	air leakage	125

Fire-rated assemblies	103
Fire-rated mortar	103
Firewalls	24
Flame characteristics	315, 323
Flashings	120
Flexduct joints	375
Floors	
cantilevered	215, 565
insulation	218-220
mobile homes	527-530
sealing cavities	132
thermal boundary	567
Flue dampers. See vent dampers	
Flue-gas analysis	317
Foam	
characteristics of materials	
115-117	
liquid sealant	103-104
one-part	104
two-part	104
Foam board	100
basement insulation	229-231
EPS	116
polyisocyanurate	117
wall sheathing	201-202
XPS	116-117
Foundation insulation	224-231
Foundations	
insulation	448
Free cooling	354, 440
Furnace fans, energy consumption	456
Furnaces	
installation	297-302
mobile homes	502-505
operating parameters	352
replacement	297-302
sealing holes in	298
temperature rise	351

## G

Galvanized steel	99
Garages	
air sealing	211
thermal boundary	568
Gas burners	
operation of	294
Gores	375
Ground moisture barrier	45, 119, 209
Ground-water drainage	39

## H

Hazardous materials	63-65
protective equipment	52, 64
Hazards	
avoiding	21-67
Health and safety	21-67
communication	57-59, 64
customer	24-54
SDS	64
worker	57-67
Heat exchangers	
mobile-home furnaces	504
Heat pumps	
efficiency	394-398
room	398-400
testing	395-396
Heat recovery ventilators	436-437
Heating systems	
electric	392-400
electric baseboard	392-393
electric furnaces	393-394
forced-air	343-379
heat pumps	394-398
hot-water	380
hydronic	303-305, 381-384
mobile homes	502-505
oil-fired	316-322
replacement	305
room heat pumps	398-400
steam	385-390

High limit		durability	118-120
hot-water heating	382	fiberglass batts	197-199, 221-223
steam	388	fiberglass, blown	219-220
Hot tubs, energy consumption	456	fire safety	141-145
House depressurization limit		foam sheathing	201-202
for determining BTL	416, 419	foundation	224-231, 448
House pressures		hydronic pipe	304
limits	348	hydronic piping	384
measuring	545	mobile home	515-530
reducing	283	non-combustible	110, 117
unbalanced airflow	348-349	polystyrene beads	117
HRVs.		pourable	117
See Heat recovery ventilators		rock wool	110
Hydronic heating systems	381-384	safety	118
<b>I</b>		steam piping	384
IAQ	21	to reduce condensation	38
See also indoor air quality		wall	182-205
Ice dams	442	wall, mobile home	522
IC-rated fixtures	128, 142	water heaters	479-483
Ignition barriers	24	Intermediate zones	
Incidental repair measure (IRM)	77	defined	545
Indoor air pollution		Intumescent paint	24
controlling	24-48, 416	<b>J-M</b>	
Indoor air quality	24-48	Kneewalls	132, 159-161
see also Ventilation		Ladders	
worker	62-63	safety	65-66
Infiltration	96	Lawrence Berkeley Laboratory (LBL)	456
See also		Lead safety	50-53
Air sealing, Air leakage		EPA RRP rule	50-51
Injuries		test	49
preventing	57-67	Lead-safe weatherization	52-53
Inspections		Leakage area	550
air conditioners	403-405	Light fixtures	
final	86	fire safety	128, 142
in-progress	86	Lighting	464-466
Insulation		fixture retrofit	467
attic	139-163	fluorescent	468
basements	227-231	multifamily	468
cellulose	109-110		
cellulose stuffing	101		
characteristics	107-117		
dense-packed cellulose	193-196		



Polyisocyanurate foam board	117	Refrigerant	
Polystyrene (EPS) beads	117	charge	407-408
Polystyrene foam		Refrigerators	
adhesive for	103	evaluation and replacement	
expanded	116	456-461	
extruded	116-117	metering	458-461
Polyurethane		Registers	
caulking	102	sealing around	371-376
foam sealant	103-104	unoccupied spaces	376
Porch roof		Renovation, repair and painting rule	
testing air leakage through	565	50-51	
Porches		Reset controllers	384
air leakage	130	Respirable particles	360
Power ventilators	445	Respirators	52, 59, 62-63
Pressure		Ridge vents	445
See also House pressures		Rim joists	
measuring differences in	545	air sealing	180
pan testing	363-366	insulation	217-218
WRT notation	545	Rock wool	110
zone leak-testing	560-561	Roof coatings	
Pressure boundary. See Air barrier		reflective	165
Pressure diagnostics. See House pressures. See Diagnostics		Roofs	
Pressure pan testing	363-366	mobile homes	515-522
Pressure tank	305	Rooftop units (RTUs)	353
and pump	304	R-values	
Pressure-relief valve	304, 382	see also Thermal resistance	
Programmable thermostats	393	of blown insulation	182
Propane	338	Safety	
finding leaks	274	commitment to	57-59
Pumps		communication	22, 57-59
hydronic, installation	304	electrical	53-54
Quality assurance	88	fire	141-145
Quality control	86, 88	insulation	118
<b>R-S</b>		ladders	65-66
Radiator valves		new employees	59
thermostatic	389	of residents	48
Radiators	383	preventing falls	65-67
Radon	46-47	storage water heaters	489-491
Rain gutters	39	tools	67
Recessed lights		vehicles	60-61
air sealing	128, 175	windows	251-253
		worker	57-67

Safety and health	21-67	safety	489-491
Safety Data Sheets (SDSs)	59, 64	Storm windows	
Scaffolding		exterior	235-237
safety	66	mobile home	531
SDS. See Safety Data Sheet		Stove cement	103
Sealants		Stuffing materials	100-101
caulking	101-103	Subcooling	407-408
foam	103-104	Sump pumps	41
one-part foam	104	Super T-8	468
two-part foam	104	Superheat	407-408
Shading		Superheat test	401-402
windows	254, 255	Supply ventilation	434-435
Silicone		<b>T-V</b>	
caulking	101	Tape	
Siliconized latex caulk	101	holding power	377
Sizing		Televisions	456
air conditioners	406	Temperature rise	
Skirting		furnace	351
mobile home	535	Termites	115, 120
Smoke alarms	27	Termiticides	115, 120
Smoke number	319	Thermal barriers	24
Soffits		Thermal boundary	
kitchen	133	see also Insulation	
Solar transmittance		basements and crawl spaces	
and cooling	254, 255	207-210	
Split-level homes	134	flaws in	96
Stairways		ideal location	568
air leakage	130, 214	Thermal resistance	
Static pressure	345-347	see also R-values	
Steady-state efficiency	296, 319	improving	173-195, 515-532
testing for	317	of insulation materials	569
Steam		Thermostatic radiator valves	389
orifices	389	Thermostats	
Steam heating	385-390	and economizers	354, 355
Steam orifices		line voltage	393
replacing steam traps	389	outdoor	398
Steam traps	385, 390	programmable	393
switching to orifices	389	two-stage	398
Steel		Tools	
galvanized	99	safety	67
Stick pins	378		
Storage water heaters	482-494		
efficiency	491-494		

Torchiere	464-466	Vermiculite	117
Trees	167	<b>W-Z</b>	
benefits	167		
Tri-level homes	134	Walls	
Utility bills		dense-packing	193-196
analysis, example	93	inspection	184-185
Valves		insulated sheathing	201-202
thermostatic radiator	389	insulation	182-205
Vapor barriers	119	Water	
Vehicle safety	60-61	drainage	39-42
Vent chutes	444	leakage	37-38
Vent connectors	328-331	Water heaters	
clearances	329, 330	energy efficiency	476-481
materials	328	installation	488-489
specifications	329	insulation	479-483
Vent dampers	384	multifamily	493-495
Ventilation		setting temperature	481
airflow, determining	417-421	storage	482-494
attic	165, 166, 442-445	Water temperature	
balanced	436	setting	481
crawl spaces	235	Water-resistive barriers	119, 245
determining need for	415	Weatherstrip	
exhaust	432-433	attic hatches	129, 212
roof and cooling	166	doors	262, 264
supply	434-435	windows	238-239
systems	431-437	Well pumps	
through windows and doors		energy consumption of	456
440-441		Windows	
whole house	431-437	double-hung,	
with economizers	354	weatherizing	240-242
see also Indoor air quality		egress	253
Venting		exterior storm	235-237
AGA categories	338	mobile home	531-532
atmospheric	328-334	reflective films	255
fan-assisted	339	repair and weatherstrip	238-239
Vents		replacement	242-249
baffles	444	safety	251-253
cutting new vents	443	sealing frames	180
net free area	444	shading	254, 255
ridge	445	solar screens	255
screens	444	Wood decay	36
		Wood heating	324-326
		clearances	324



inspection checklist	325
Wood stoves	
UL-listed	324
Work orders	84-85
Worst-case draft test	97, 276-277
Zones	
combustion-appliance	276
input vs. reference	545
intermediate	362, 545
pressure testing	560-561
simple pressure test	560



# VIDEO LIBRARY

## CHAPTER 1: HEALTH AND SAFETY

---

---



### **Video: Fire Resistance and Containment**

— A look at the materials, assemblies, and standards that help to keep buildings safe from fire and smoke.



**Video: Healthy homes inspection**— An inspector performs a health inspection on a home and conducts a client interview.



**Video: Indoor environmental hazards**— A discussion of the riskiest environmental hazards.



### **Video: Moisture movement and control**

— A discussion about healthy and safety problems caused by moisture.



### **Video: Lead-Safe Weatherization Intro**

— Working with lead-based paint, and how to do it safely.



**Video: Tenting the work area**— How to hang plastic sheeting to protect the home during weatherization work.



**Video: Worker Safety Plan**— Develop a plan to avoid injuries and job related illnesses.



**Video: Respirators**— Proper use and care of fit tested respirators, along with other personal protective equipment.

## **CHAPTER 2: ENERGY AUDITS AND QUALITY CONTROL INSPECTIONS**

---

---



**Video: Measuring a home**— A summary of measuring a home identifying weatherization opportunities.

## **CHAPTER 3: WEATHERIZATION MATERIALS**

---

---



**Video: Air sealing a home**— Methods and materials for air sealing site-built homes.

## **CHAPTER 4: ATTICS AND ROOFS**

---

---



**Video: Air sealing and shielding metal chimneys**— Method and materials used to safely shield and air seal a metal chimney.



**Video: Attic Insulation Preparation**— All of the steps necessary to inspect and prepare an attic for insulation.

---

---

## **CHAPTER 5: WALLS**



**Video: Densepack retrofit insulation tools and procedures**— Hoses, area prep, dense-packing from indoors and outdoors, area cleanup.



**Video: Using 2-part and 1-part spray foam**— Hands-on demonstration of using these two insulation materials.

---

---

## **CHAPTER 8: HEATING AND COOLING SYSTEMS**



**Video: Worst-case CAZ depressurization**— How to analyze and troubleshoot CAZ depressurization.



**Video: Natural drafting chimneys**— Discussion about the various type of appliances that use atmospheric chimneys.



**Video: Heating and Cooling efficiency**  
— An explanation of the various types in terms related to efficiency



**Video: Duct energy efficiency**— An overview of the elements that make up and affect the energy efficiency of duct systems.



**Video: Introduction to Duct induced house pressures**— An introduction to duct induced house pressures.



**Video: Unbalanced duct airflow**— A discussion about how unbalanced duct airflow pressurized and depressurizes different parts of the building.



**Video: Duct leakage and house pressures**  
— An explanation of how duct leakage pressurizes the building.



**Video: Pressure pan test**— How to use a pressure pan test to gauge the location and relative severity of duct leakage.



**Video: Connecting duct tester to air handler**— How to install a duct tester on an example air handler.



**Video: Duct pressurization test setup**  
— How to pressurize duct to test air leakage.

## **CHAPTER 10: BASELOAD MEASURES**

---

---



**Video: Wrapping a Water Heater**— Using a blower door and manometer to qualify air leakage across various parts of the pressure boundary.

## **CHAPTER 11: MOBILE HOMES**

---

---



**Video: Mobile Home Duct Sealing**— Proper materials and procedures for sealing ducts in mobile homes.



**Video: Roof cavity insulation**— E\$P shows several ways of insulating mobile home roof cavities.



**Video: Denspack Mobile Home Sidewall**

— A weatherization crew shows how they denspack a mobile home wall from the exterior.



**Video: Retrofitting Batt Insulation in a Mobile Home Sidewall**— A weatherization crew shows some methods to retrofit insulation batts in a mobile home.



**Video: Belly repair for insulation**— How to repair, air seal, and insulate mobile home belly pans.

---

---

## CHAPTER 12: AIR LEAKAGE DIAGNOSTICS



**Video: Why measure building shell air leakage?**— A perspective on building shell air leakage testing, using blower doors, and why do we measure air leakage anyway?



**Video: Setting up the DG700**— How to set up the DG700 manometer for diagnostic testing.



**Video: Simple pressure diagnostics**— How to perform pressure diagnostics during a blower-door test.





**Video: Zone pressure diagnostics**— Using a blower door and manometer to qualify air leakage across various parts of the pressure boundary.

